



U-Match

SLIM CONCEALED DUCT AIR CONDITIONING & HEATING SYSTEM INSTALLATION MANUAL

Models:

Indoor Unit

UMAT18HP230V1AD

UMAT24HP230V1AD

UMAT30HP230V1AD

UMAT36HP230V1AD

UMAT42HP230V1AD

UMAT48HP230V1AD

Outdoor Unit

UMAT18HP230V1AO

UMAT24HP230V1AO

UMAT30HP230V1AO

UMAT36HP230V1AO

UMAT42HP230V1AO

UMAT48HP230V1AO



Thank you for choosing a U-Match Slim Concealed Duct unit for your customer.

Please read this installation manual carefully before installing and starting up the U-Match System. Take a moment to fill out the product and installation form on the back cover. Retain both the manual and installation record for future reference.

Table of Contents

<i>Safety Precautions</i>	2
<i>Nomenclature</i>	3
<i>System Requirements</i>	4
<i>Suggested Tools</i>	5
<i>System Schematic</i>	6
<i>Standard Parts</i>	7
<i>Installation Site Instructions</i>	8-9
<i>Indoor Unit Installation</i>	10-12
<i>Outdoor Unit Installation</i>	13-14
<i>Piping Installation</i>	15-19
<i>Ductwork Installation</i>	20-22
<i>Power and Wiring Installation</i>	23-25
<i>Controller Installation and setup</i>	26-27
<i>Testing and Inspection</i>	28-30
<i>Troubleshooting</i>	31-32
<i>Diagnostic Codes</i>	33-36
<i>Care and Cleaning</i>	37

SAFETY PRECAUTIONS

Please read the following before installation.



This is the safety alert symbol. It is used to alert you to potential personal injury hazards. Obey all safety messages that follow this symbol to avoid possible injury or death.

⚠ WARNING

This mark indicates procedures which, if improperly performed, might lead to the death or serious injury of the user.

⚠ CAUTION

This mark indicates procedures which, if improperly performed, might possibly result in personal harm to the user, or damage to property.

NOTICE

Notice is used to address practices not related to personal injury.

General Safety Precautions

1. Instructions for installation and use of this product are provided by the manufacturer. For proper operation, the system must be installed in accordance with this installation manual.
2. Installation must be performed in accordance with local laws, regulations and National Electrical Codes (NEC).
3. If refrigerant leaks while work is being carried out, ventilate the area. Do not allow refrigerant to come in contact with a flame as it produces toxic gas.
4. Disconnect all electrical power to the indoor and outdoor units until the system is ready for start-up and checkout.
5. When installing or repairing the system, use only R410A refrigerant. Do not mix refrigerant with other gases. If air or other gas enter the refrigeration system, the pressure inside the system may rise to an abnormally high value and cause damage or injury.

⚠ WARNING

This appliance is not intended for use by persons (including children) with reduced physical, sensory or mental capabilities, or lack of experience and knowledge, unless they have been given supervision or instruction concerning use of the appliance by a person responsible for their safety.

NOMENCLATURE

Indoor unit

Example: UMAT18HP230V1AD

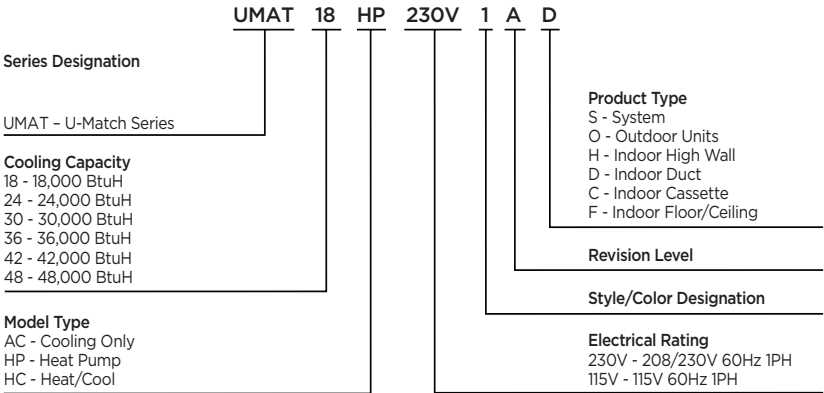

Outdoor unit

Example: UMAT18HP230V1AO

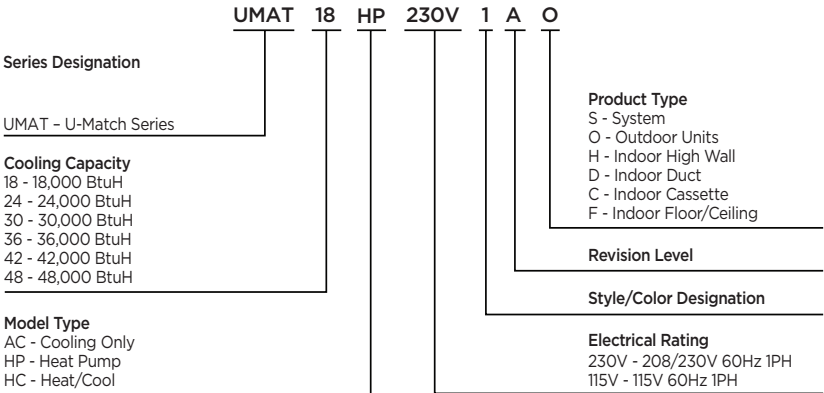

SYSTEM REQUIREMENTS

PIPE SIZE in (mm)

REFRIGERANT LINE LENGTHS ft (m)

Unit Size (BtuH)	Liquid Line	Suction/Gas Line	Min Line Length	Max. Pre-Charge Line Length	Max Line Length	Max Elevation (ID over OD)
18,000	1/4 (6)	1/2 (12)	10 (3)	25(7.5)	164 (50)	49 (15)
24,000	3/8 (10)	5/8 (15)	10 (3)	25(7.5)	164 (50)	49 (15)
30,000	3/8 (10)	5/8 (15)	10 (3)	25(7.5)	164 (50)	49 (15)
36,000	3/8 (10)	5/8 (15)	10 (3)	25(7.5)	164 (50)	49 (15)
42,000	3/8 (10)	5/8 (15)	10 (3)	25(7.5)	164 (50)	98 (30)
48,000	3/8 (10)	5/8 (15)	10 (3)	25(7.5)	230 (70)	98 (30)

Notes: Insulate both refrigerant lines, separately.

REFRIGERANT CHARGE

Unit Size (BtuH)	Refrigerant Type	Factory System Charge oz (kg)*	Additional Charge oz/ft (g/m)
18,000	R410A	49.4 (1.4)	0.3 (30)
24,000	R410A	78.4 (2.2)	0.6 (60)
30,000	R410A	84.6 (2.4)	0.6 (60)
36,000	R410A	123.2 (3.6)	0.6 (60)
42,000	R410A	131.2 (3.8)	0.6 (60)
48,000	R410A	141.8 (4.1)	0.6 (60)

*Precharge amount for up to 25-ft of refrigerant pipe.

INDOOR UNIT ELECTRICAL REQUIREMENTS

Unit Size (BtuH)	Voltage	Min Circuit Amps (MCA)	Max Overcurrent Protection (MOCP)	Main Power Wire Size (AWG)
18,000	208/230v - 1ph 60hz	1.0	15	14
24,000	208/230v - 1ph 60hz	2.0	15	14
30,000	208/230v - 1ph 60hz	2.0	15	14
36,000	208/230v - 1ph 60hz	3.0	15	14
42,000	208/230v - 1ph 60hz	3.0	15	14
48,000	208/230v - 1ph 60hz	5.0	15	14

OUTDOOR UNIT ELECTRICAL REQUIREMENTS

Unit Size (BtuH)	Voltage	Min Circuit Amps (MCA)	Max Overcurrent Protection (MOCP)	Main Power Wire Size (AWG)
18,000	208/230v - 1ph 60hz	15.9	25	10
24,000	208/230v - 1ph 60hz	23.4	40	10
30,000	208/230v - 1ph 60hz	23.4	40	10
36,000	208/230v - 1ph 60hz	27.7	45	8
42,000	208/230v - 1ph 60hz	29.7	50	8
48,000	208/230v - 1ph 60hz	36.5	70	6

Communication Cable: Recommended cable - 18/2 AWG stranded bare copper conductors 300V unshielded wire Note: Use shielded cable if installation is in close proximity of RF and EMI transmitting devices.

SUGGESTED TOOLS



• *Standard Wrench*



• *Adjustable/Crescent Wrench*



• *Torque Wrench*



• *Hex Keys or Allen Wrenches*



• *Drill & Drill Bits*



• *Hole Saw*



• *Pipe Cutter*



• *Screw drivers (Phillips & Flat blade)*



• *Manifold and Gauges*

• *Level*

• *R410A Flaring Tool*

• *Clamp on Amp Meter*

• *Vacuum Pump*

• *Safety Glasses*

• *Work Gloves*

• *Refrigerant Scale*

• *Micron Gauge*

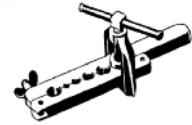

SYSTEM SCHEMATIC

Indoor Unit

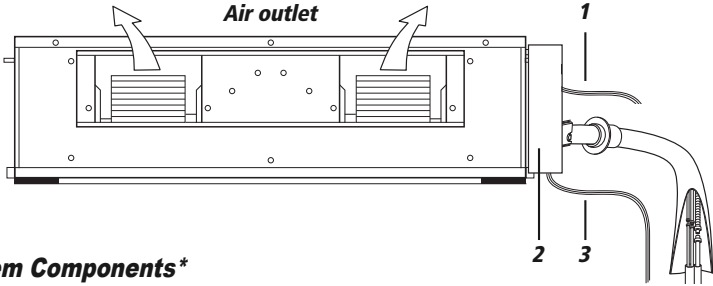

System Components*

1. Indoor Power Supply
2. Electric Box
3. Communication Cable
4. XK60 Wired Programmable Controller
5. Communication Cable
6. Front Panel
7. Service Cover
8. Liquid Pipe
9. Gas Pipe
10. Drain Hose
11. Outdoor Power Supply



* Not all components included with equipment purchase.

Outdoor Unit

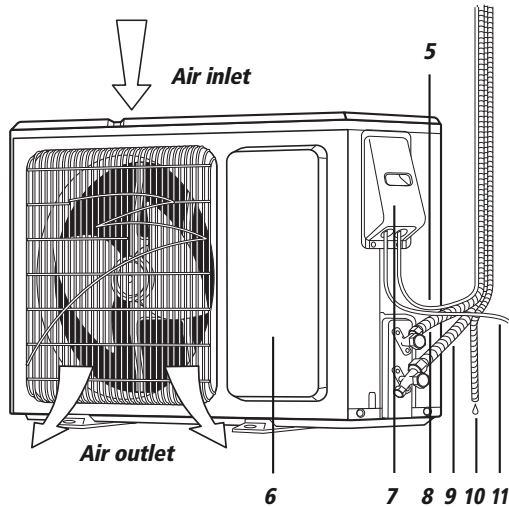











CAUTION

The refrigerant pipe, drain pipe, electrical wiring, and duct for this unit should be installed by a qualified HVAC professional only.

STANDARD PARTS

Indoor Unit Accessories

No.	Name	Appearance	Qty	Usage
1	Wired Controller		1	Controls the indoor unit
2	Hanger		4	Supports the indoor unit
3	Nut with Washer		8	Fastens the hanger brackets to the cabinet of the unit
4	Nut with Washer		4	Fastens the hanger brackets to the cabinet of the unit
5	Nut		4	Used with the suspension bolt for installing the unit
6	Washer		4	Used with the suspension bolt for installing the unit
7	Pipe Insulation		1	Insulates the gas pipe
8	Pipe Insulation		1	Insulates the liquid pipe
9	Fastener		4	Fastens the insulation blanket
10	Flare Nut		1	Connects the liquid pipe
11	Flare Nut		1	Connects the gas pipe

Outdoor Unit Accessories

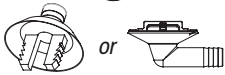
No.	Name	Appearance	Qty	Usage
1	Drain Plug		2 or 3	Plugs the unused drain hole
2	Drainage Connector		1	Connects with the hard PVC drain pipe

INSTALLATION SITE INSTRUCTIONS

Indoor Unit

WARNING

The unit must be installed in a location which can withstand twice the weight of the unit. Inadequate building support at the installation location may result in serious property damage and injuries.

Review the installation location with the customer as follows:

1. Ceiling is strong enough to support twice the weight of the unit.
2. Ductwork can easily be installed using the shortest amount of duct.
3. Location allows easy installation of drain pipe.
4. Electrical power can easily be run as a dedicated circuit.
5. Space is left around the unit as required in Fig. 1.1 for future service and maintenance.
6. Air inlet and outlet of the unit should never be blocked, so airflow can reach every corner of the room.

Fig. 1.1

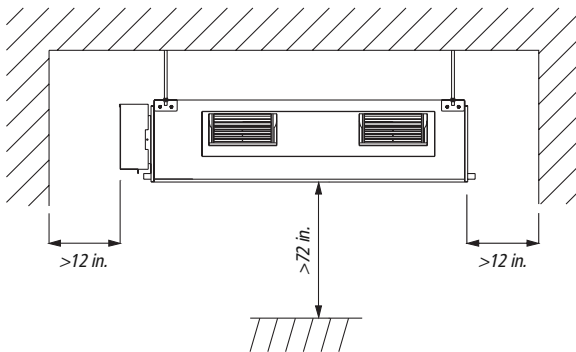

INSTALLATION SITE INSTRUCTIONS

Outdoor Unit

WARNING

The unit should be installed level on a pad that can support twice the weight of the unit. If the outdoor unit will be exposed to strong winds, it must be adequately secured.

CAUTION

Do not install the unit at a location where the distance exceeds the maximum length indicated in the table. The maximum length of the connection pipe is listed in the System Requirements section.

1. Install the outdoor unit at a location that is capable of withstanding twice the weight of the unit.
2. Install the outdoor unit where it is convenient to connect refrigerant lines to the indoor unit.
3. Install the outdoor unit where the condensate water can be drained unobstructed during the heating mode to a safe location.
4. Do not locate the unit where the noise may be objectionable to neighbors.
5. Provide the space shown in Fig. 1.2, so that the air flow is not blocked and future service and maintenance can be performed.

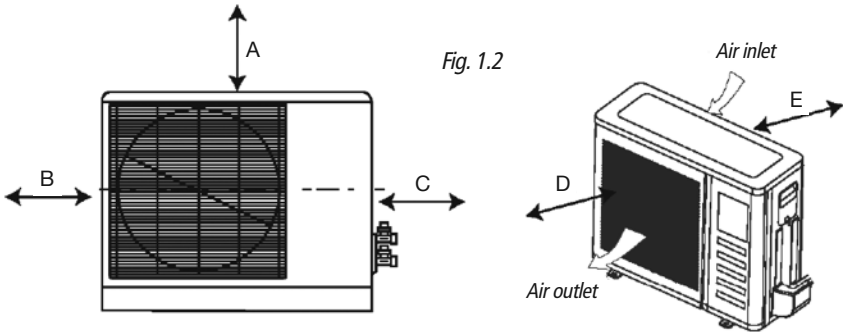

Outdoor Unit	Minimum Distances in (mm)
A	20 (500)
B	20 (500)
C	24 (610)
D	12 (305)
E	12 (305)

INDOOR UNIT INSTALLATION

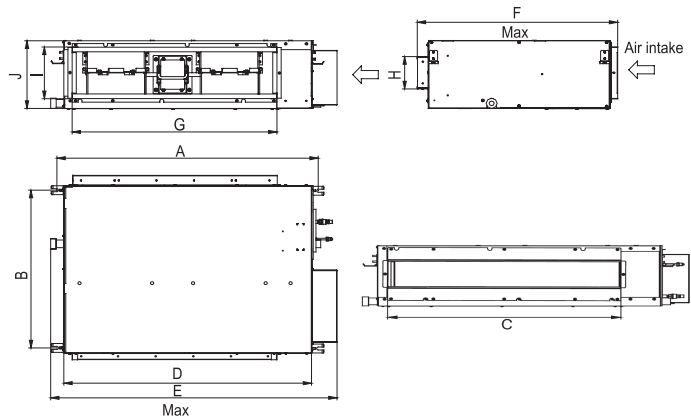

For the units: 18K

INDOOR UNIT DIMENSIONS in (mm)

Model	A	B	C	D	E	F	G	H	I	J
UMAT18HP230V1AD	37-1/4 (945)	24-3/8 (618)	29 (738)	35-1/8 (892)	40-7/8 (1037)	28-3/8 (721)	29 (738)	4-7/8 (125)	8 (203)	10-1/2 (266)

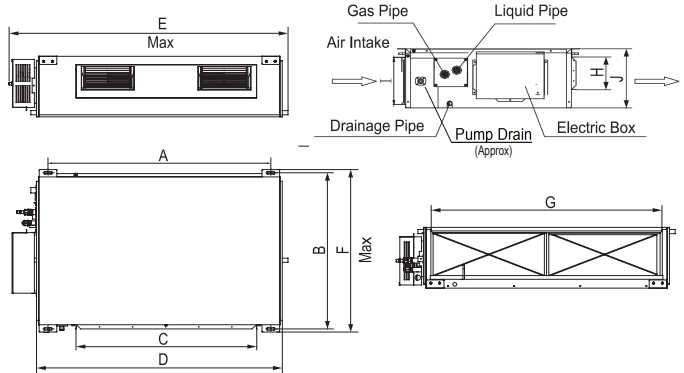

For the units: 24-42K

INDOOR UNIT DIMENSIONS in (mm)

Model	A	B	C	D	E	F	G	H	I	J
UMAT24HP230V1AD	43-3/8 (1101)	20-3/8 (517)	32-1/4 (820)	45-5/8 (1159)	50-3/8 (1279)	22 (558)	39-1/2 (1002)	6-1/4 (160)	9-1/4 (235)	10-1/2 (268)
UMAT30HP230V1AD	43-3/8 (1101)	29-1/2 (748)	32-1/4 (820)	43-7/8 (1115)	48-1/4 (1226)	30-1/2 (775)	38-1/2 (979)	6-1/4 (160)	9-1/8 (231)	11-3/8 (290)

INDOOR UNIT INSTALLATION

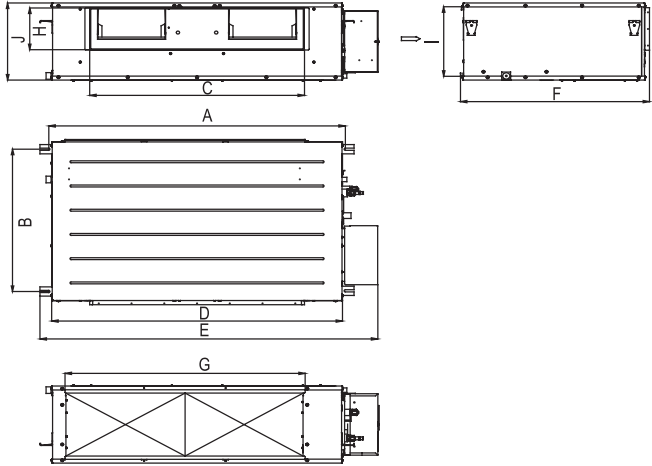

For the units: 48K

INDOOR UNIT DIMENSIONS in (mm)

Model	A	B	C	D	E	F	G	H	I	J
UMAT48HP230V1AD	43-3/8 (1101)	25-3/8 (646)	33-1/2 (852)	45-1/4 (1150)	52-3/4 (1340)	29-1/2 (750)	37-1/2 (953)	7-1/2 (190)	12-1/2 (316)	13-3/4 (350)

INDOOR UNIT INSTALLATION

Mounting Indoor Unit

It is critical to properly secure the indoor unit to a stable and rigid structure that can support twice its weight for safety and product reliability.

Select the proper size suspension bolts or anchoring devices (field supplied) to support twice the weight of the unit.

1. Locate a structure strong enough to support twice the weight of the unit.
2. Using the installation template supplied with the unit, mark the hole locations as shown in fig 2.1.
3. Drill 4 mounting holes for suspension bolts per the manufacturer's instructions.
4. Install 4 suspension bolts into pre-drilled holes.
5. Install the 4 hanger brackets to unit as shown in fig 2.2.
6. Add an upper nut to each suspension bolt.
7. Carefully lift unit and position the 4 hanger brackets on the suspension bolts.
8. Install a lower washer and nut to each suspension bolt to secure unit as shown in fig 2.3.
9. Adjust the unit height to desired position.

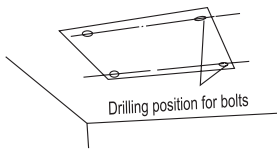

Fig. 2.1

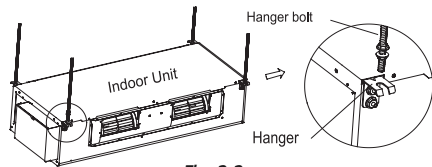

Fig. 2.2

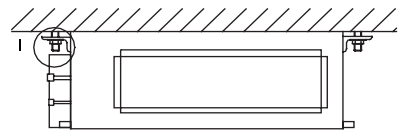
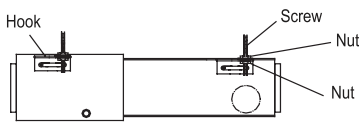
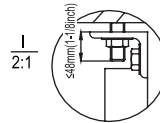

Fig. 2.3



Leveling

After the indoor unit is installed and adjusted to proper height, check the unit position to ensure that the unit is level as shown below.

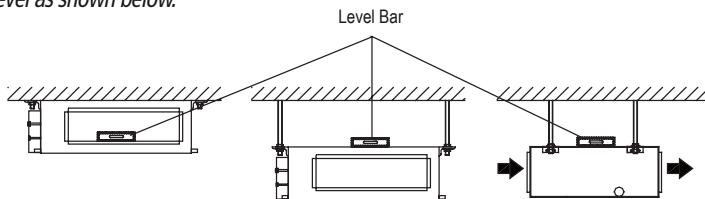

Fig. 2.4

OUTDOOR UNIT INSTALLATION

WARNING

The unit should be located with the unit support feet firmly on the equipment pad. If the outdoor unit is exposed to wind, it must be properly secured.

18K-36K

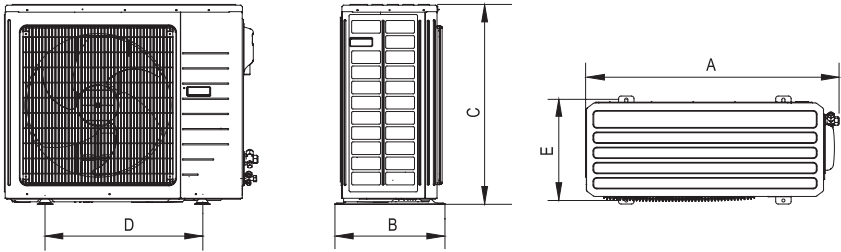

42K-48K

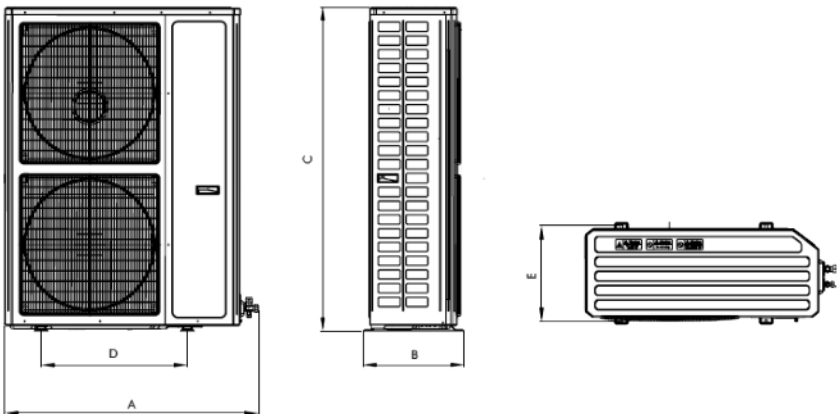

OUTDOOR UNIT DIMENSIONS in (mm)

Model	A	B	C	D	E
UMAT18HP230V1AO	37-5/8 (955)	15-5/8 (396)	27-1/2 (700)	22 (560)	14-1/8 (360)
UMAT24HP230V1AO UMAT30HP230V1AO	38-5/8 (980)	16-3/4 (427)	31-1/8 (790)	24 (610)	15-1/2 (395)
UMAT36HP230V1AO UMAT42HP230V1AO	43-5/8 (1107)	17-3/8 (440)	43-1/4 (1100)	24-7/8 (631)	15-3/4 (400)
UMAT48HP230V1AO	37-3/4 (958)	16-1/4 (412)	53-1/8 (1349)	22-1/2 (572)	14-3/4 (376)

OUTDOOR UNIT INSTALLATION

Condensate Drainage of the Outdoor Unit

The outdoor unit should be installed with a drain pipe to drain condensate water during the heating mode.

1. Insert the drain joint (included) into the selected hole located on the bottom of the base pan and then connect the drain hose (field supplied) to the drain joint.
2. All other holes must be sealed with plugs (included) to avoid water leaks, except for the drain pipe mounting hole.
3. Route drain hose to safe location for disposing of condensate water.

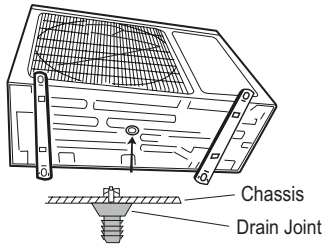
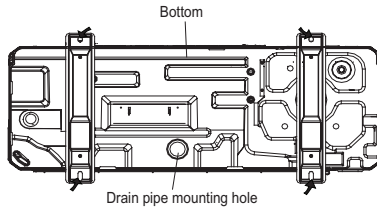

PIPING INSTALLATION

Refrigerant Piping

Drill Hole in Wall

1. Locate and mark proper location for the wall hole.
2. Cut the 2 3/4" wall hole with a 5° to 10° downward slant to the outdoors.
3. Insert a wall sleeve (field supplied) into hole to prevent damage to refrigerant pipes, insulation, condensate drain hose and wiring.
4. Proper weather proofing of the wall surface and wall sleeve is essential to assure a trouble-free installation. Apply sealant, caulking or equivalent weather proofing material around the perimeter of the wall sleeve (interior & exterior) to eliminate outdoor air and water leaks into the living space.

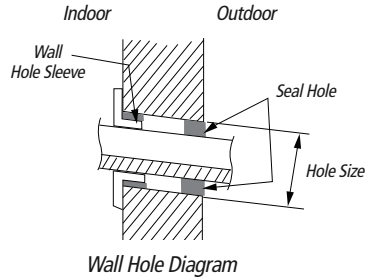

NOTE: Expandable foam insulation may be added to fill large wall gaps. Apply per manufacturer's instructions.

Piping Preparation

1. Do not open service valves or remove protective caps on pipes until instructed by this manual.
2. Keep tubing free of dirt, sand, moisture and contaminants.
3. Insulate each refrigerant pipe and condensate hose with minimum 3/8" (10 mm) wall thermal pipe insulation.

CAUTION

Insulate entire interior section of condensate hose to prevent sweating which may cause water stains or wall damage.

4. Bind refrigerant pipes and interconnecting cable together with cable ties at 12-inch intervals.
5. Include the condensate hose in bundle for exterior portion only.

Indoor Unit below Outdoor Unit Application

When height difference between indoor unit and outdoor unit is more than 30 feet, an oil return bend should be added for every 20 feet of connection pipe as shown.

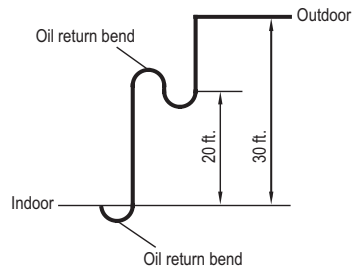

PIPING INSTALLATION

Indoor Unit Pipe Connections

1. Feed refrigerant pipes, drain hose and interconnecting wires assembly through wall hole from outdoor to the indoor unit.
2. Pull the piping assembly to the unit. Carefully bend refrigerant pipes to meet indoor unit connection ports. Use proper tools to avoid kinks.
3. Add a small amount of refrigerant oil to both ends of the flare fittings.
4. Starting with either refrigerant pipe, carefully center the pipe to the indoor unit connection port then hand tighten the flare nut.
5. Repeat procedure with remaining pipe.
6. Tighten both flare nuts using a standard wrench and a torque wrench as shown below.

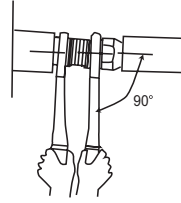
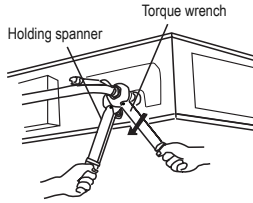
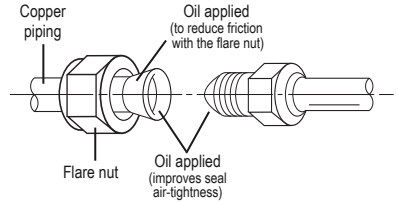

7. Carefully tighten flare nuts to correct torque level referring to the Torque Table below.

Pipe Diameter inch (mm)	Nut Size inch (mm)	Tightening Torque	
		ft-lbs	N-m
1/4 (6.35)	1/4 (17)	10 to 13	14 to 18
3/8 (9.5)	3/8 (22)	25 to 30	34 to 42
1/2 (12.7)	1/2 (25)	36 to 45	49 to 61
5/8 (15.9)	5/8 (29)	50 to 60	68 to 82

CAUTION

Over tightening may damage flare connections and cause leaks.

8. Individually insulate each bare refrigerant pipe and joint as shown below to prevent sweating.

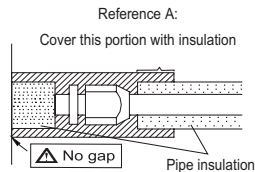
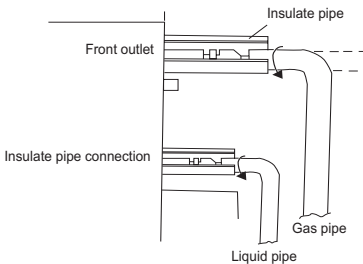

PIPING INSTALLATION

Outdoor Unit Pipe Connections

1. Remove service valve cover (if provided) to access the service valves and refrigerant ports.
2. Carefully bend and adjust length of refrigerant pipes to meet outdoor unit service valve connections with proper tools to avoid kinks.
3. Add a small amount of refrigerant oil to both ends of the flare fittings.
4. Starting with either refrigerant pipe, carefully center the pipe to the indoor unit connection port then hand tighten the flare nut.
5. Repeat procedure with remaining pipe.
6. Tighten both flare nuts using a standard wrench and a torque wrench as shown.
7. Carefully tighten flare nuts to correct torque level referring to the Torque Table below.

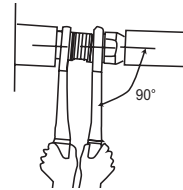
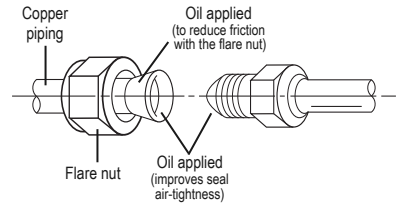
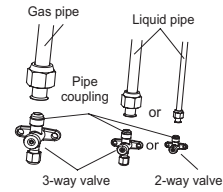
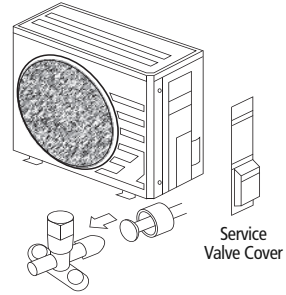

Pipe Diameter inch (mm)	Nut Size inch (mm)	Tightening Torque	
		ft-lbs	N-m
1/4 (6.35)	1/4 (17)	10 to 13	14 to 18
3/8 (9.5)	3/8 (22)	25 to 30	34 to 42
1/2 (12.7)	1/2 (25)	36 to 45	49 to 61
5/8 (15.9)	5/8 (29)	50 to 60	68 to 82



CAUTION

Over tightening may damage flare connections and cause leaks.

PIPING INSTALLATION

Indoor Condensate Drain Piping

WARNING

Observe all local sanitary codes when installing condensate drains.

See Table below for Condensate Drainage port size.

Capacity Size (BtuH)	Drain Connection Size (OD)
18,000	ϕ 1-1/8 (30)
24,000-48,000	ϕ 3/4 (20)

Pitch the condensate drain pipe at a gradual 2.5% pitch (Example: 1/4-in drop over a 10-in length) without obstructions. Use pipe hanger/brackets to support the condensate drain pipe from dropping.

NOTE: Insulate entire interior section of condensate hose and/or pipes to prevent sweating which may cause water stains or wall damage.

CAUTION When utilizing gravity condensate drainage, the internal lift condensate pump must be disconnected and its wiring insulated to prevent shorting. All unused condensate drain ports must be plugged to prevent leakage.

Typical Gravity Drainage System

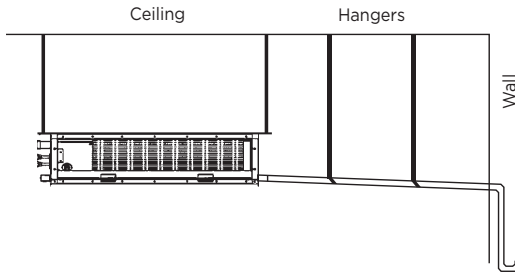

Gravity Drainage System with P-Trap and Vent

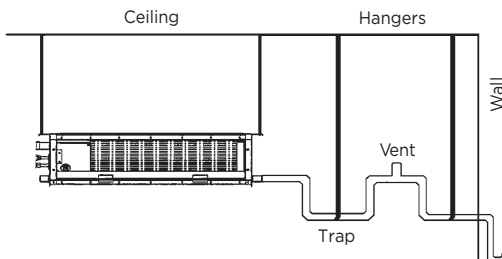

PIPING INSTALLATION

Vertical Lift Drainage System (Internal Condensate Pump)

If a gradual pitch from the drainage port is not obtainable, the indoor unit has a lift condensate drain pump*with limited head or lift. The condensate drain pipe may have a vertical height of 33 in. maximum above the unit drainage port within the first 12-in as long as the remaining condensate drain pipe gradually descends from that point and is aligned with drainage port.

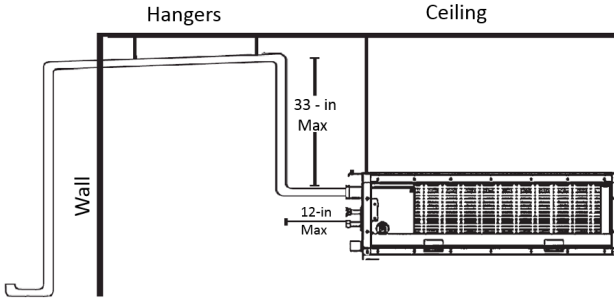

The unit has two gravity drain ports and a factory installed condensate pump with an outlet port. The condensate pump port must be utilized for condensate removal or the pump may be disconnected from the control board if a gravity drain port is desired. If disconnected the condensate pump plug must be electrically insulated to prevent an accidental short circuit. Use piping of the same diameter or larger as the unit connection. Local code should be referenced for approved condensate piping for your area.

Use an auxiliary condensate pump with float valve for vertical height greater than 33 in. above the unit drainage port. A float valve is recommended to shut off the system if the auxiliary pump fails.

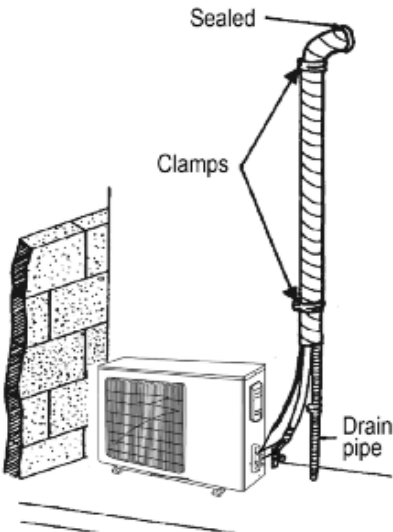

- Include the condensate hose in the pipe/wire bundle for the exterior/outdoor section.
- Fasten the refrigerant and condensate pipe assembly to the exterior wall for support.
- The drain pipe should terminate 6 inches above grade.

DUCTWORK INSTALLATION

Design and Layout of Ductwork

The ductwork configuration should be based on the conditions of the building and maintenance etc., as shown below.

Indoor Fan Performance

— High speed
— Low speed

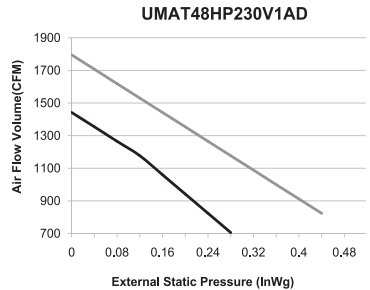
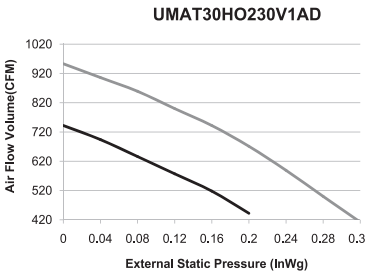
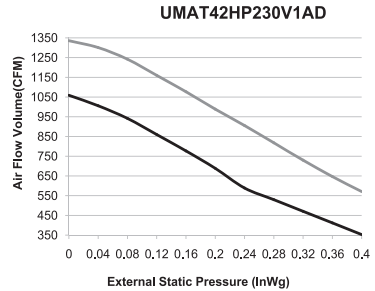
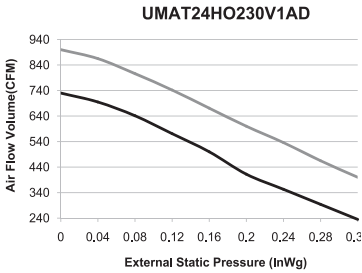
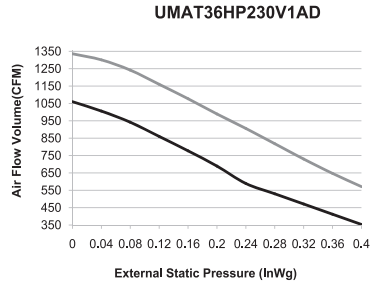
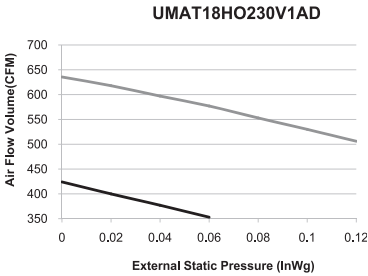

DUCTWORK INSTALLATION

Duct Sizing Suggestions

Correct ductwork design is critical to insure proper system performance. The total length of the ductwork is the length of the return air duct plus the supply air duct. It is recommend that the ductwork and register selection should follow ACCA manual D duct design to insure proper velocity and air flow.

NOMINAL EXT. STATIC PRESSURE

Capacity Size (BtuH)	18K	24K	30K	36K	42K	48K
Air Flow Rate (CFM)	585	820	820	1175	1175	1470
Ext. Static Pressure (InWg)	0.1	0.1	0.15	0.15	0.15	0.2

Duct Connection Requirements

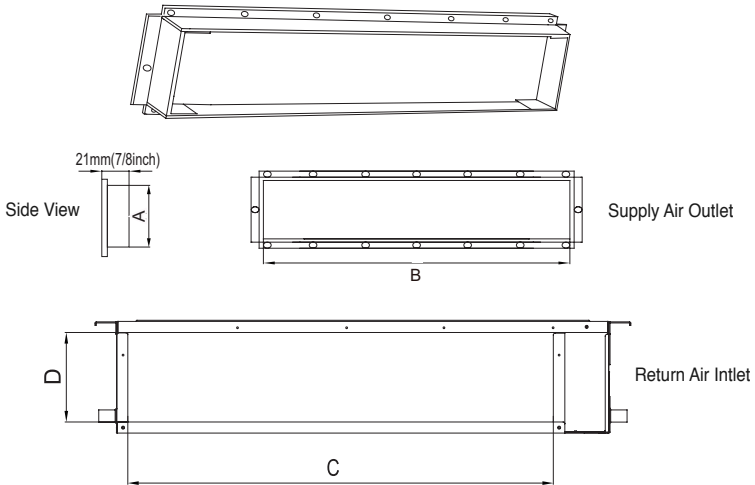

SUPPLY AIR OUTLET/RETURN AIR INLET DIMENSIONS in (mm)

Model	Supply Air Outlet		Return Air Inlet	
	A	B	C	D
UMAT18HP230V1AD	4-7/8 (123)	29 (736)	28 (710)	6-1/2 (166)
UMAT24HP230V1AD	6-1/4 (158)	32-1/4 (818)	39-1/8 (994)	7-5/8 (195)
UMAT30HP230V1AD	6-1/4 (158)	32-1/4 (818)	39-1/8 (994)	7-5/8 (195)
UMAT36HP230V1AD	6-1/4 (158)	32-1/4 (818)	39-3/8 (1000)	8-1/8 (206)
UMAT42HP230V1AD	6-1/4 (158)	32-1/4 (818)	39-3/8 (1000)	8-1/8 (206)
UMAT48HP230V1AD	7-1/2 (190)	33-1/2 (850)	37 (940)	11-1/4 (286)

DUCTWORK INSTALLATION

Bottom Return Air Installation (18,000 BtuH Only)

The 18,000 BtuH size duct can be converted from a rear to bottom side return. More noise is produced with the bottom return air location than the rear return air, so it is suggested to provide a duct silencer to minimize the noise. The default location of the return air connection is at the rear.

If the bottom return air connection is desired, switch the location of the rectangular flange and the return air cover plate as shown below:

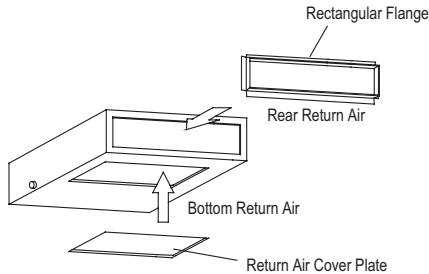

Attaching Ductwork to Indoor Unit

1. Connect return air duct (#3) to the return air inlet of the unit (#4) and the other end to a return air register. Ensure return ductwork is properly supported with hangers.
2. Connect supply air duct (#5) to the supply air outlet of the unit (#4) and the other end to a discharge air register. Ensure supply ductwork is properly supported with hangers.

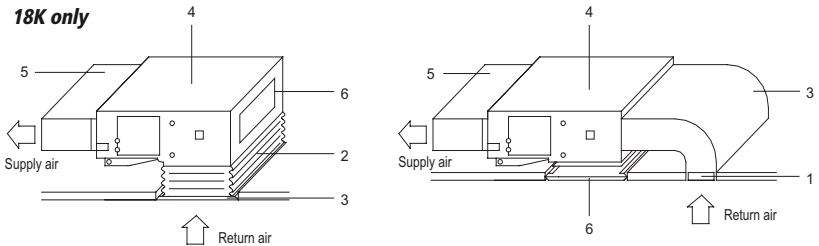

Part Name

1. Return Air Inlet (with filter)
2. Canvas Duct
3. Return Air Duct
4. Indoor Unit
5. Supply Air Duct
6. Return Air Cover Plate(18K only)

WARNING

- 1. Before obtaining access to terminals, all electrical supply circuits must be disconnected.*
- 2. Always use an independent circuit and provide an independent circuit breaker to supply power to the system.*
- 3. Use a circuit breaker with adequate capacity to meet the requirements of the total system.*
- 4. A circuit breaker or fuse should be installed per the National Electric Code (NEC) and local regulations.*
- 5. Electrical wiring must be completed in accordance with NEC, local laws, and regulations of the electric company so that the system will operate properly.*
- 6. Provide a GFI circuit breaker at the electrical panel in accordance with the NEC and the local electrical company standards.*
- 7. Connect the connection wires firmly to the terminal block. Improper installation may cause a fire.*

CAUTION

- 1. The main power supplies and fresh air damper are high-voltage, while the communication wire and the Programmable Controller are low-voltage. They should be installed separately to avoid electromagnetic interference.*
- 2. High-voltage and low-voltage lines should pass through separate rubber rings at electric box covers.*
- 3. If the indoor unit communication wire (to the outdoor unit) and power wire are connected incorrectly, the air conditioner may be damaged.*
- 4. Ground both indoor unit and outdoor unit to earth ground in accordance with the applicable local and national codes.*

POWER AND WIRING INSTALLATION

Electric Wiring Between Indoor Unit and Outdoor Unit

Typical Wiring Diagram

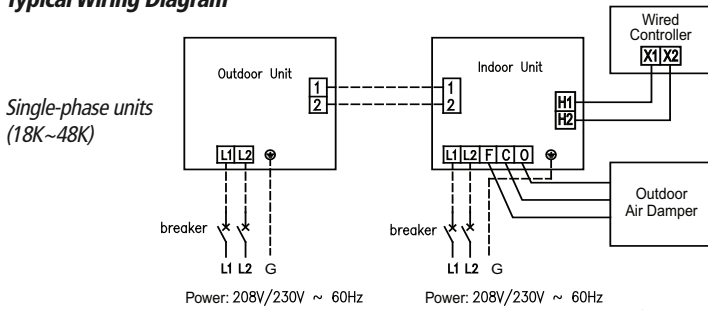

Indoor Unit Electrical Wiring

Locate and remove the electrical box cover to access wire terminals.

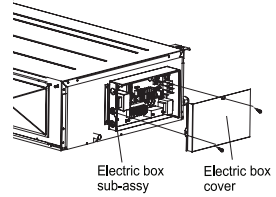

Indoor Communication Wiring

The recommended communication cable size is a minimum 18/2 AWG stranded bare copper conductors 300V unshielded wire. Use shielded cable if installation is in close proximity of RF and EMI transmitting devices. Locate wire terminals #1 and #2. Connect communication cable from outdoor unit to terminals #1 and #2. Secure cable inside wire clamp/strain relief. Verify cable is secure, not loose and no external force on wires affects the connections at the terminals.

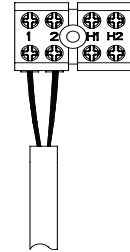

NOTE: Record wire colors and terminal references for use with Outdoor Unit wire connections.

Indoor Unit Power Wiring

Locate wire terminals L1 and L2. Connect main electrical power outdoor unit to terminals L1 and L2. Connect ground wire to grounding screw. Secure electrical wires inside wire clamp/strain relief. Verify wires are secure, not loose and no external force on wires affects the connections at the terminals.

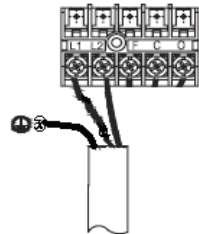

Programmable Controller Wiring

Use a minimum 18-2 AWG wire (field supplied) to connect Programmable Controller to the indoor unit. Route wire from Programmable Controller into electrical box. Locate wire terminals H1 and H2. Connect Programmable Controller wires to H1 and H2. Verify wires are secure, not loose and no external force on wires affects the connections at the terminals.

POWER AND WIRING INSTALLATION

Outdoor Air Damper Wiring (optional)

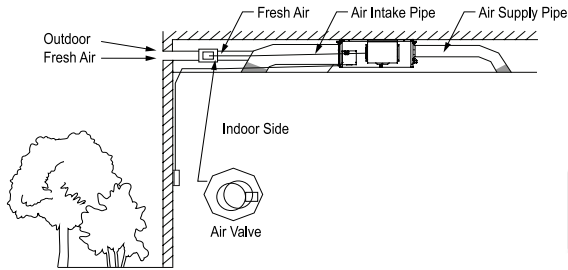

Follow the manufacturer's instructions for installing and wiring the outdoor air damper. On the indoor unit, locate wire terminals F, C, O for outdoor air damper. Make necessary connections to F (Common), C (Close) and O (Open) terminals. Secure electrical wires inside wire clamp/strain relief. Verify wires are secure, not loose and no external force on wires affects the connections at the terminals.

Outdoor Unit Electrical Wiring

Remove the large handle access plate on the 18K to 30K size or the front panel for the 36K to 48K size to access wire terminals.

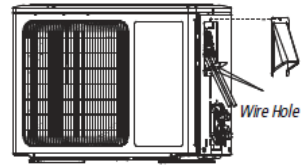

Outdoor Communication Wiring

Connect communication cable from indoor unit to terminals #1 and #2. Maintain the same wire colors and terminal references as indoor unit wire connections.

NOTE: Crossing communication wires will cause an E6 system malfunction code and possible damage.

Secure cable inside wire clamp/strain relief. Verify cable is secure, not loose and no external force on wires affects the connections at the terminals.

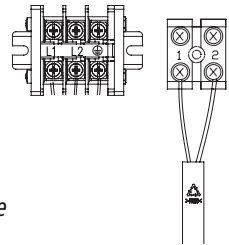

Outdoor Unit Power Wiring

Insert main power wires through the wire holes on conduit mounting bracket. Secure main electrical power conduit with locking nuts to conduit mounting bracket. Locate wire terminals L1 and L2. Adjust wire lengths for proper connections to the outdoor unit terminal block. Connect main electrical power outdoor unit to terminals L1 and L2. Connect Ground wire to ground terminal/screw. Secure electrical wires inside wire clamp/strain relief. Verify wires are secure, not loose and no external force on wires affects the connections at the terminals. Replace and secure electrical box cover to outdoor unit.

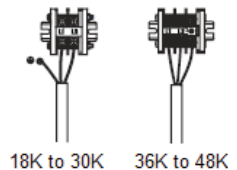

NOTE: When connecting the power wire, make sure that the phase of the power supply matches with the exact terminal board. If not, the compressor will rotate reversely and run improperly.

CONTROLLER INSTALLATION AND SETUP

The following is a brief overview of the Wired Programmable Controller installation. See Owner's Manual for more detailed instructions for setup and operation.

Preparation for Installation

Select a proper location on the wall for mounting the Programmable Controller. Install switch box, if required by code. The maximum wire length between indoor and Programmable Controller is 30-ft. Run communication cable (as desired) between indoor unit and selected wall mounting location. See Indoor Unit wiring section for instruction to connect the Wired Programmable Controller to the indoor unit.

Wired Programmable Controller Installation

Pull communication cable through switch box (if one is used) and Wired Programmable Controller backplate. Securely fasten backplate to the switch box or wall.

Locate wire terminals X1 and X2 on rear of Programmable Controller panel. Carefully connect wire X1 to indoor unit terminal H1 and X2 to indoor unit terminal H2. Verify wires are secure, not loose and no external force on wires affects the connections at the terminals. Push extra cable into wall and secure controller panel to backplate mounted on the wall.

NOTE: Do not cut or splice communication cable.

Follow the instructions supplied with the Owner's Manual for setup and operation.

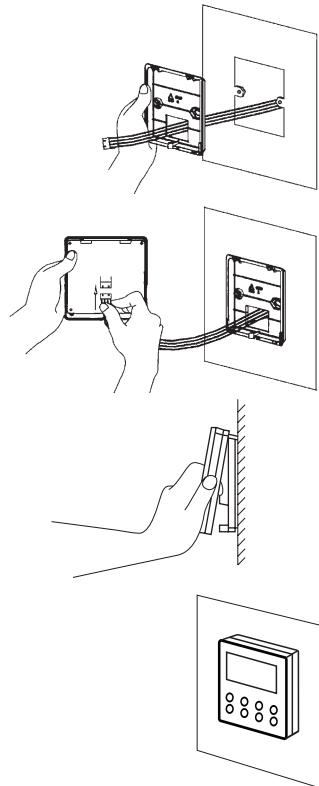

CONTROLLER INSTALLATION AND SETUP

Unit Control Indicators

The Slim Duct unit has a basic user interface panel and display. It operates in conjunction with the Programmable Controller.

There are two buttons on the panel. A "Cool" button which will force the unit into Cool Mode with a 79° F (26° C) set temperature. And a "Heat" button which will force the unit into heat mode with a 68° F (20° C) set temperature.

The dual 7-segment display will display error codes to speed up troubleshooting and repairs.

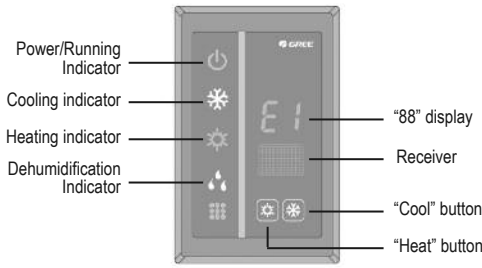

NOTE: When the unit is connected with the wired controller, the error code will be simultaneously shown on it.

Setting Double Indoor Room Sensors

This series of ducted air conditioner has two indoor room sensors. One is located at the air intake of the indoor unit and the other is located inside the Programmable Controller. The user can select one from the two indoor room sensors on the basis of their own preference. Refer to the Owner's Manual for detailed instructions.

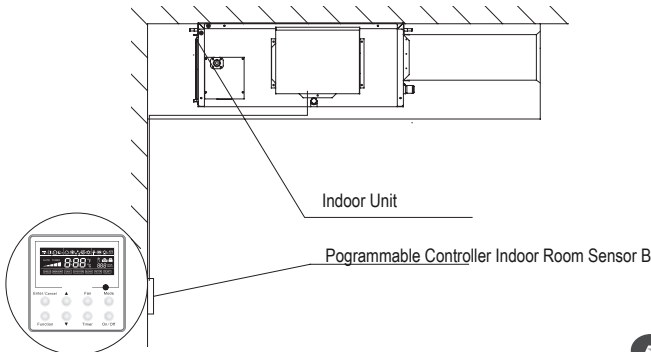

TESTING AND INSPECTION

Pipe Testing

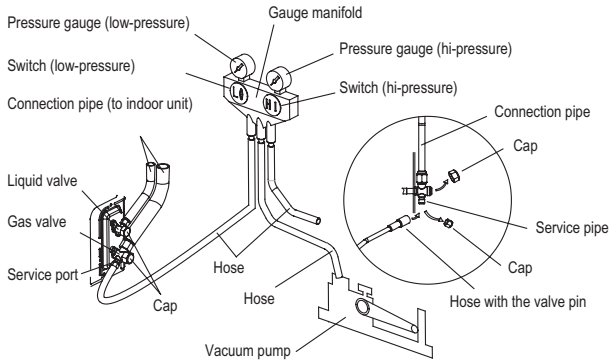

Leak Test Refrigerant lines should be pressurized prior to evacuating system to check for leaks.

1. Connect regulated nitrogen to manifold. Attach hose to service port.
2. Open manifold valve to add nitrogen to a pressure of 500 lbs.
3. Maintain applied pressure for 30 minutes, leak-test flare fittings with soap bubbles. If no leak is detected, release nitrogen.

NOTE: You may want to perform leak testing and evacuation before wiring to save time, electrical connections can be completed while your vacuum pump is running.

CAUTION

Use vacuum pump, rather than refrigerant, to discharge air when installing the unit.

Additional Charge

Refrigerant for the pipe length of 25 feet has been charged at the factory. If the piping is greater than 25 feet additional charging is necessary. For the additional amount, see the table below.

Model	Add'l Refrigerant (oz/ft (g/m))
18,000	0.3 (30)
24,000	0.6 (60)
30,000	0.6 (60)
36,000	0.6 (60)
42,000	0.6 (60)
48,000	0.6 (60)

TESTING AND INSPECTION

Vacuum Procedure

Important: Use a quality Micron Gauge to measure and validate the proper system vacuum level achieved. Do not rely on the scale of a "bourbon tube" type gauge set to validate the depth and quality of the vacuum.

1. Remove the caps of the liquid valve, gas valve and service port.
2. Connect gauge manifold and micron gauge to the service ports provided at the liquid and suction service valves.
3. Connect a vacuum pump to the manifold gauge.
4. Open the lower pressure side of the manifold valve assembly and start the vacuum pump. The switch at the high pressure side of the manifold valve assembly should be kept closed, or evacuation does not fail.
5. Operate vacuum pump until a vacuum of 500 microns or less is achieved. The evacuation duration depends on the vacuum pump size and unit's capacity, generally 20 minutes for the 9,000 BtuH units, to 1 hour for a larger 36,000 BtuH unit.
6. Close the manifold valves and shut off the pump.
 - a. If vacuum holds below 700 microns for 15 minutes, the system can be considered dry and leak free. Go to step 5.
 - b. If vacuum increases to 800 microns or greater, this is an indication of moisture in system or a leak exists. Identify leak and repair as necessary, after which repeat steps 4 and 5. If moisture is suspect, purge system use triple evacuation method using dry nitrogen.
7. Confirm that manifold valves are closed and disconnect the vacuum pump.
8. Open the service valves to the fully 'back-seat' position to let the refrigerant flow to the indoor unit and balance the pressure in system.

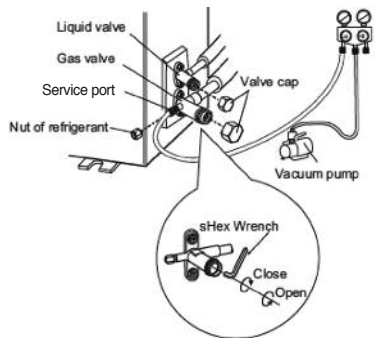

Note: Do not allow air to enter the connection pipe when removing the hose.

9. Replace service valve caps and tighten.

TESTING AND INSPECTION

Start-up Checklist

☐ **Turn on main power to indoor and outdoor units.**

- Verify the system is not displaying an error code on the indoor unit or *Wired Programmable Controller display*.

☐ **Press the ON button on the Wired Programmable Controller.**

- Verify the *Wired Programmable Controller display* turns ON.

☐ **Press the Mode button to Cooling.**

Adjust the room setpoint to bring the system on in cooling mode. The system should start cooling mode within 3-5 minutes.

- Verify the outdoor fan and compressor are operating.
- Verify the indoor fan is operating.
- Verify the indoor discharge air is cooling the room.

☐ **Press the Mode button to Heating.**

Adjust the room setpoint to bring the system on in heating mode. The system should start heating mode within 3-5 minutes.

- Verify the outdoor fan and compressor are operating.
- Verify the indoor fan is operating.
- Verify the indoor discharge air is heating the room.

☐ **Press the OFF button on the Wired Programmable Controller.**

- Verify *Wired Programmable Controller display* turns OFF and the system shuts OFF.

☐ **Test the Drain Piping.**

- Verify condensate water drains smoothly. As shown in the figure, add approximately 1 quart of water slowly into the drain pan. The condensate pump should turn on and drain the water through the condensate drain pipe to a safe location. Verify there are no leaks in the condensate pipe and connections.

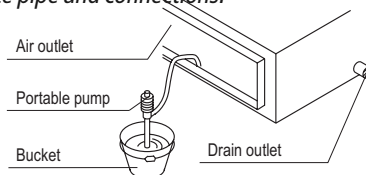

TROUBLESHOOTING

PROBLEM	CAUSE/SOLUTION
System does not restart.	<p>Cause: The system has a built-in three-minute delay to prevent short and/or rapid cycling of the compressor.</p> <p>Solution: Wait three minutes for the protection delay to expire.</p>
Indoor unit emits unpleasant odor when started	<p>Cause: Typically unpleasant odors are the result of mold or mildew forming on the coil surfaces or the air filter.</p> <p>Solution: Wash indoor air filter in warm water with mild cleaner. If odors persist, contact a qualified service professional to clean the coil surfaces.</p>
You hear a "water flowing" sound.	<p>Cause: It is normal for the system to make "water flowing" or "gurgling" sounds from refrigerant pressures equalizing when the compressor starts and stops</p> <p>Solution: The noises should discontinue as the refrigerant system equalizes after two or three minutes.</p>
A thin fog or vapor coming out of the discharge register when system is running.	<p>Cause: It is normal for the system to emit a slight fog or water vapor when cooling extremely humid warm air.</p> <p>Solution: The fog or water vapor will disappear as the system cools and dehumidifies the room space.</p>
You hear a slight cracking sound when the system stops or starts.	<p>Cause: It is normal for the system to make "slight cracking" sounds from parts expanding and contracting during system starts and stops.</p> <p>Solution: The noises will discontinue as temperature equalizes after 2 or 3 minutes.</p>
The system will not run.	<p>Cause: There are a number of situations that will prevent the system from running.</p> <p>Solution: Check for the following:</p> <ul style="list-style-type: none"> • Circuit breaker is "tripped" or "turned off." • Power button of Wired Programmable Controller is not turned on. • Wired Programmable Controller is in sleep mode or timer mode. • Otherwise, contact a qualified service professional for assistance.
The unit is not heating or cooling adequately.	<p>Cause: There are a number of reasons for inadequate cooling or heating.</p> <p>Solution: Check the following:</p> <ul style="list-style-type: none"> • Remove obstructions blocking airflow into the room. • Clean dirty or blocked air filter that is restricting airflow into the system. • Seal around door or windows to prevent air infiltration into the room. • Relocate or remove heat sources from the room.

TROUBLESHOOTING

PROBLEM	CAUSE/SOLUTION
<i>Water leakage from the outdoor unit.</i>	<p>Cause: It is normal for the outdoor unit to generate condensate water in the reverse cycle heating and defrost mode.</p> <p>Solution: This is normal. No action is required.</p>
<i>Water leaking from the indoor unit into the room.</i>	<p>Cause: While it is normal for the system to generate condensate water in cooling mode, it is designed to drain this water via a condensate drain system to a safe location.</p> <p>Solution: If water is leaking into the room, it may indicate one of the following.</p> <ul style="list-style-type: none">• The indoor unit is not level right to left. Level indoor unit.• The condensate drain pipe is restricted or plugged. All restrictions must be removed to allow continuous drainage by gravity.• If problem persists, contact a qualified service professional for assistance.
<i>The unit will not deliver air.</i>	<p>Cause: There are a number of system functions that will prevent air flow.</p> <p>Solution: Check for the following:</p> <ul style="list-style-type: none">• In heating mode, the indoor fan may not start for three minutes if the room temperature is very low. This is to prevent blowing cold air.• In heat mode, if the outdoor temperature is low and humidity is high, the system may need to defrost for up to 10 minutes before beginning a heating cycle.• In dry mode, the indoor fan may stop for up to three minutes during the compressor off delay.• Otherwise, you should contact a qualified service professional for assistance.

DIAGNOSTIC CODES

The U-Match System has on board diagnostics. The indoor unit and Wired Programmable Controller will display error codes. The following is a summary of the codes with explanation:

Error Codes

No.	Error Code	Malfunction Name	Origin of Malfunction	Description
1	E1	High Pressure Protection	High Pressure Switch	If outdoor unit detects the high pressure switch is cut off for 3-sec successively, high pressure protection will occur. All the loads (except the 4-way valve in heating mode) will be switched off. In this case, all the buttons and remote control signals except ON/OFF button will be disabled and system won't be recovered automatically. Switch off the unit or re-energize the unit after cutting off power to eliminate this protection.
2	E2	Indoor Coil Freeze Protection	Indoor Evaporator Temperature Sensor	If indoor unit detects the evaporator temperature is lower than protective temperate value after the unit has been running for a period of time under cooling or dry mode, the unit will report this fault, in which case the compressor and outdoor fan motor will be stopped. The unit will not run until evaporator temperature is higher than the protective temp. value and the compressor is stopped for 3-min.
3	E3	Low Pressure Protection	Low Pressure Switch	If outdoor unit detects low-pressure switch is open during ON or standby state within 30-sec successively the unit will report a low pressure protection. If the fault occurs 3 times successively within 30-min, the unit will not recover automatically.
		Low Refrigerant Protection		If the unit reports low refrigerant level within 10-min after turning on the unit, the unit will stop operation. If the fault occurs successively 3 times, the unit cannot be recovered automatically.
		Refrigerant Recycling Mode		If the unit enters refrigerant recovery mode through special operation, E3 will be displayed. After exiting refrigerant recovery mode, the code will disappear.
4	E4	Compressor High Discharge Temperature Protection	Compressor Discharge Temperature	If outdoor unit detects the discharge temperature is higher than protective temperature value, the unit will report high discharge temperature protection. If the protection occurs over 6 times, the unit cannot be recovered automatically. Switch off the unit or re-energize the unit after cutting off power to reset this protection.
5	E6	Communication Malfunction	Communication Failure Between Indoor and Outdoor Main Board	If the outdoor unit does not receive data from indoor unit, communication malfunction will be reported. If there is communication abnormality between display board and indoor unit, communication malfunction will be reported.

DIAGNOSTIC CODES

Error Codes

No.	Error Code	Malfunction Name	Origin of Malfunction	Description
6	E8		Indoor Fan Motor	If the indoor unit does not receive signal from indoor fan motor for 30-sec successively when the fan motor is operating, indoor fan motor malfunction will be reported. In this case, the unit can automatically resume operation after stopping. If the malfunction occurs 6 times within one hour, the unit cannot be recovered automatically. Switch off the unit or re-energize the unit after cutting off power to eliminate this malfunction.
7	E9	Condensate Overflow Protection	Overflow Switch	If indoor unit detects the condensate overflow switch warning for 8-sec successively, the system will enter condensate overflow protection. The unit will shut off and will not recover automatically. Switch unit off and then switch it on to eliminate this malfunction.
8	F0	Indoor Ambient Temperature Sensor at Return Air Inlet Malfunction	Indoor Ambient Temperature Sensor	If indoor unit detects the indoor ambient temperature sensor is open circuit or short circuit for 5-sec successively, indoor ambient temp. sensor malfunction will be reported. The unit can automatically resume operation after the malfunction disappears. If indoor ambient temperature sensor malfunction occurs in fan mode, only the error code is displayed and the indoor unit will operate normally.
9	F1	Indoor Evaporator Coil Temperature Sensor Malfunction	Evaporator Coil Temperature Sensor	If indoor unit detects the evaporator temperature sensor is open circuit or short circuit for 5-sec successively, evaporator temperature sensor malfunction will be reported. The unit can automatically resume operation after the malfunction disappears. If evaporator temperature sensor malfunction occurs in fan mode, only the error code is displayed and the indoor unit will operate normally.
10	F2	Indoor Condenser Coil Temperature Sensor Malfunction	Condenser Coil Temperature Sensor	If outdoor unit detects the condenser coil temperature sensor open circuit or short circuit for 5-sec successively, condenser coil temperature sensor malfunction will be reported. The unit can automatically resume operation after the malfunction disappears. If condenser temperature sensor malfunction occurs in fan mode, only the error code is displayed and the indoor unit will operate normally.

DIAGNOSTIC CODES

Error Codes

No.	Error Code	Malfunction Name	Origin of Malfunction	Description
11	F3	Outdoor Ambient Temperature Sensor Malfunction	Outdoor Ambient Temperature Sensor	If outdoor unit detects the outdoor ambient temperature sensor open circuit or short circuit for 5-sec successively, outdoor ambient temperature sensor malfunction will be reported. The unit can automatically resume operation after the malfunction disappears. If outdoor ambient temperature sensor malfunction occurs in fan mode, only the error code is displayed and the indoor unit will operate normally.
12	F4	Compressor Discharge Temperature Sensor Malfunction	Compressor Discharge Temperature Sensor	If outdoor unit detects the compressor discharge temperature sensor is open circuit or short circuit for 5-sec successively after the compressor has been operating for 3-min, outdoor discharge temperature sensor malfunction will be reported. The unit can automatically resume operation after the malfunction disappears.
13	F5	Wired Controller Temperature Sensor Malfunction	Wired Controller Temperature Sensor	If the Wired Programmable Controller detects open circuit or short circuit of its temperature sensor for 5-sec successively, wired controller temperature sensor malfunction will be reported.
14	ee	Outdoor Drive Memory Chip Malfunction	Outdoor Drive Board	If the memory chip of outdoor drive circuit board fails, the unit will not start. The unit will not recover automatically. If thermo junction cannot be eliminated after switching off the unit and then energizing the unit several times, replace the outdoor drive circuit board.
15	H3	Compressor Overload Protection	Compressor Overload Switch	If outdoor unit detects the compressor overload switch open within 3-sec successively, the unit will report compressor overload protection. If the fault occurs successively 3 times, the unit will not recover automatically. Switch off the unit or re-energize the unit to eliminate this protection.
16	H4	Overload Protection	Evaporator Temperature, Condenser Temperature	If indoor unit detects the evaporator coil temperature is higher than protective temp. value, the unit will report overload protection. The unit will restart operation after evaporator temperature is lower than the protective temp. value and the compressor is stopped for 3-minutes. If the protection occurs over 6 times, the unit will not recover automatically. Switch off the unit or re-energize the unit to eliminate this protection.

DIAGNOSTIC CODES

Error Codes

No.	Error Code	Malfunction Name	Origin of Malfunction	Description
17	H6	Outdoor Fan Motor Malfunction	Outdoor Fan Motor	If outdoor unit does not receive feedback signal from outdoor fan motor for 30-sec successively when the fan motor is operating, an outdoor fan motor malfunction will be reported. In this case, the unit can automatically resume operation after stopping. If the malfunction occurs 6 times within one hour, the unit will not recover automatically. Switch off the unit or re-energize the unit to eliminate this malfunction.
18	U7	Reversing or 4-way Valve Malfunction	Reversing/ 4-way Valve	After the compressor starts operation in heating mode, if the outdoor unit detects the difference between evaporator temperature and indoor ambient temperature is lower than the protective value for 10-min successively, Reversing Valve Malfunction will be reported and the outdoor unit will stop operation. If the malfunction occurs 3 times, the unit will not recover automatically. Switch off the unit or re-energize the unit to eliminate this malfunction.
19	P6	Main Control and Drive Communication Malfunction	Communication Failure Between Indoor and Outdoor Main Board	If the outdoor main control board does not receive data from drive board, communication malfunction between main control and drive will be reported. The malfunction will be eliminated automatically.
20	EE	Outdoor Main Control Memory Chip Malfunction	Outdoor Main Control Board	If the memory chip on the outdoor main control board fails, the unit will not start. The unit will not recover automatically. If thermo junction cannot be eliminated after switching the unit off and on for several tries, replace the outdoor main control board.

CARE AND CLEANING

Routine Maintenance

NOTE: Filters should be installed before operating the air conditioner, otherwise dirt or dust could enter the unit. Do not remove the air filter except for cleaning.

Cleaning

The air filter should be cleaned every 90 days. Cleaning frequency should be increased if the unit is installed in a room where there is an abnormal amount of dirt and dust.

1. Remove the air filter from the duct.
2. Clean the air filter. Remove dust from the air filter using a vacuum cleaner and gently rinse in cool water with mild detergent. Don't use hot water to avoid filter shrinking or deformation. After cleaning the filter, dry filter before replacing.
3. Replace the air filter.

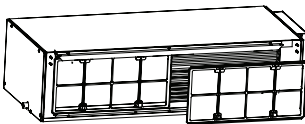
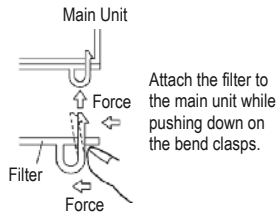
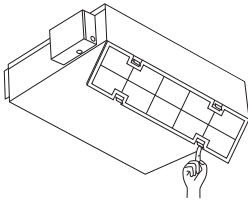

Press the air filter downward into the guided groove. Then pull the top outward.

NOTE: The 24K-48K sizes have two separate air filters.



GREE ELECTRIC APPLIANCES, INC.

www.greecomfort.com

PRODUCT & INSTALLATION RECORD

For your convenience, please record the model and serial numbers of your new equipment in the spaces provided. This information, along with the installation data and dealer contact information, will be helpful should your system require maintenance or service.

UNIT INFORMATION

Outdoor Unit:

Model No. _____

Serial No. _____

Indoor Unit:

Model No. _____

Serial No. _____

INSTALLATION INFORMATION

Date Installed: _____

DEALERSHIP/INSTALLER INFORMATION

Company Name: _____

Address: _____

Phone Number: _____

Technician Name: _____

