



Service Manual

Ultra Heat GMV Multi VRF

—Heat Recovery Series

TECHNICAL SERVICE MANUAL (R410A)

Installation, Commissioning, and Maintenance Manual for Ultra Heat GMV Multi VRF Units

For North America

Refrigeration Research Department
July, 2016

Gree Electric Appliances, Inc. of Zhuhai

CONTENTS

CONTENTS.....	i
PREFACE.....	1
SAFTY PRECAUTIONS.....	1
CHAPTER 1 INTRODUCTION TO BASIC FEATURES OF UNITS.....	7
1 BASIC OPERATING PRINCIPLE.....	7
2 INTERNAL PIPING DESIGN OF THE UNITS.....	8
3 BASIC PARAMETERS OF UNIT.....	13
4 ELECTRICAL PARAMETERS.....	18
5 OPTIONAL ACCESSORIES.....	20
6 BASIC REQUIREMENT FOR PIPE CONNECTION.....	20
7 PRECAUTIONS ON REFRIGERANT LEAKAGE.....	22
8 UNIT OPERATING TEMPERATURE.....	23
CHAPTER 2 INSTALLATION.....	26
PART 1 ENGINEERING INSTALLATION PREPARATION.....	26
1 INSTALLATION SAFETY.....	26
2 IMPORTANCE OF INSTALLATION ENGINEERING.....	26
3 COOPERATION BETWEEN DIFFERENT PROFESSIONS.....	27
4 ONSITE REVIEW OF DESIGN DRAWING.....	30
5 CONSTRUCTION ORGANIZATION PROCESS.....	31
PART 2 MATERIAL SELECTIONS.....	32
1 REQUIREMENT FOR SELECTING CONSTRUCTION MATERIALS.....	32
2 REQUIREMENT FOR SELECTING MAJOR MATERIALS.....	32
PART 3 INSTALLATION SPACE REQUIREMENTS.....	34
1 PLACE SELECTION FOR INSTALLING ODU.....	34
2 ODU DIMENSIONS AND INSTALLATION HOLE SIZE.....	34
PART 4 REQUIREMENTS ON FOUNDATION INSTALLATION.....	43
1 ODU FOUNDATION.....	43
2 ODU FIXING.....	44
3 VIBRATION REDUCTIONS FOR ODU.....	44
PART 5 PIPING CONNECTION.....	45
1 SCHEMATIC DIAGRAM OF PIPING CONNECTION.....	45
2 SCHEMATIC DIAGRAM OF PIPING SEQUENCE.....	45
3 ALLOWABLE PIPE LENGTH AND DROP HEIGHT AMONG IDU AND ODU.....	46
4 CONNECTION PIPE AMONG ODU MODULES.....	47
5 SIZE REQUIRMENT FOR FITTING PIPE AND BRANCH.....	48
PART 6 PIPE INSTALLATION AND INSULATION.....	53
1 PIPE INSTALLATION FOR THE COOLING SYSTEM.....	53
2 PIPE INSTALLATIONS FOR THE CONDENSATE WATER SYSTEM.....	61
3 INSULATION SYSTEM.....	64
PART 7 ELECTRIC AND CONTROLLER INSTALLATION.....	66
1 PRECAUTION.....	66
2 INSTALLATION OF THE POWER CABLE.....	67
3 INSTALLATION OF THE COMMUNICATION SYSTEM.....	72
PART 8 VACUUMIZATION AND DESICCATION FOR THE REFRIGERANT SYSTEM.....	82
1 AIR-TIGHTNESS TEST.....	82
2 VACUUMIZATION AND DESICCATION FOR THE SYSTEM.....	83

PART 9 REFRIGERANT PERFUSION.....	85
1 CALCULATION METHOD FOR PERFUSING REFRIGERANT.....	85
2 METHOD FOR PERFUSING REFRIGERANT.....	86
CHAPTER 3 COMMISSIONING OPERATION.....	91
PART 1 SECURITY REQUIREMENTS.....	91
1 PRECAUTIONS FOR CONSTRUCTION.....	91
2 PRECAUTIONS FOR THE USE OF REFRIGERANTS.....	91
3 FUNCTION SETTINGS OF ODUS.....	91
PART 2 COMMISSIONING PROCESS.....	102
1 NECESSITY OF VRF ENGINEERING COMMISSIONING.....	102
2 REQUIRED FILES AND TOOLS FOR ENGINEERING DEBUGGING.....	102
3 ENGINEERING COMMISSIONING PROCEDURES.....	103
CHAPTER 4 MAINTENANCE.....	122
PART 1 FAILURE CODE TABLE.....	122
1 SYSTEM FAILURE CODE TABLE.....	122
2 ODU LEDS TABLE.....	125
PART 2 EXCEPTIONS AND TROUBLESHOOTING.....	128
1 HOW TO LOCATE A FAULTY IDU PROMPTLY.....	128
2 EXCEPTIONS ANALYZING AND TROUBLESHOOTING.....	129
PART 3 KEY PARTS MAINTENANCE.....	148
1 CAUTIONS ON CONTROLLER REPLACEMENT.....	148
2 COMPRESSOR REPLACEMENT AND CAUTIONS.....	151
3 CAUTIONS ON COMPRESSOR DRIVE BOARD AND PFC BOARD REPLACEMENT.....	166
4 ASSEMBLING AND DISASSEMBLING KEY PARTS OF ODUS.....	171
5 UNIT MAINTENANCE.....	183
PART 4 APPENDIXES.....	184
1 MINUTES ABOUT A DEBUG SOLUTION CONFIRMATION MEETING.....	184
2 VISUAL INSPECTION CHECKLIST OF THE DEBUG SYSTEM.....	184
3 DEBUG PARAMETER RECORD LIST.....	185
4 COMMON PARAMETER LISTS.....	186
5 EXPLODED VIEWS AND SPARE PART LIST.....	197

PREFACE

This manual specifies safe operation requirements for Ultra Heat GMV VRF units from perspectives of engineering and installation, commissioning and maintenance, as well as basic principles and implementation methods. Professional operators must abide by relevant national (local) safety requirements and technical specifications set forth in this manual during operations; otherwise, the air conditioning system may fail or be damaged, and personnel safety accident may also occur.

SAFTY PRECAUTIONS

To prevent injury to the user or other people and property damage, the following instructions must be followed.

Incorrect operation due to ignoring instruction will cause harm or damage. The seriousness is classified by the following indications.

	This is the safety alert symbol. It is used to alert you to potential personal injury hazards. Obey all safety messages that follow this symbol to avoid possible injury or death.
WARNING	This mark indicates procedures which, if improperly performed, might lead to the death or serious injury of the user.
CAUTION	This mark indicates procedures which, if improperly performed, might possibly result in personal harm to the user, or damage to property.
NOTICE	NOTICE is used to address practices not related to personal injury.

▲WARNING**◆ Installation**

Have all electric work done by a licensed electrician according to "Electric Facility Engineering Standard" and "Interior Wire Regulations" and the instructions given in this manual and always use a special circuit.

If the power source capacity is inadequate or electric work is performed improperly, electric shock or fire may result.

Ask the dealer or an authorized technician to install the air conditioner.

Improper installation by the user may result in water leakage, electric shock, or fire.

Always ground the product.

There is risk of fire or electric shock.

Always install a dedicated circuit and breaker.

Improper wiring or installation may cause fire or electric shock.

For re-installation of the installed product, always contact a dealer or an Authorized Service Center.

There is risk of fire, electric shock, explosion, or injury.

Do not install, remove, or re-install the unit by yourself (customer).

There is risk of fire, electric shock, explosion, or injury.

Do not store or use flammable gas or combustibles near the air conditioner.

There is risk of fire or failure of product.

Use the correctly rated breaker or fuse.

There is risk of fire or electric shock.

Prepare for strong wind or earthquake and install the unit at the specified place.

Improper installation may cause the unit to topple and result in injury.

Do not install the product on a defective installation stand.

It may cause injury, accident, or damage to the product.

When installing and moving the air conditioner to another site, do not charge it with a different refrigerant from the refrigerant specified on the unit.

If a different refrigerant or air is mixed with the original refrigerant, the refrigerant cycle may malfunction and the unit may be damaged.

Do not reconstruct to change the settings of the protection devices.

If the pressure switch, thermal switch, or other protection device is shorted and operated forcibly, or parts other than those specified by GREE are used, fire or explosion may result.

Ventilate before operating air conditioner when gas leaked out.

It may cause explosion, fire, and burn.

Securely install the cover of control box and the panel.

If the cover and panel are not installed securely, dust or water may enter the outdoor unit and fire or electric shock may result.

If the air conditioner is installed in a small room, measures must be taken to prevent the refrigerant concentration from exceeding the safety limit when the refrigerant leaks.

Consult the dealer regarding the appropriate measures to prevent the safety limit from being exceeded.

Should the refrigerant leak and cause the safety limit to be exceeded, hazards due to lack of oxygen in the room could result.

◆Operation

Do not damage or use an unspecified power cord.

There is risk of fire, electric shock, explosion, or injury.

Use a dedicated outlet for this appliance.

There is risk of fire or electrical shock.

Be cautious that water could not enter the product.

There is risk of fire, electric shock, or product damage.

Do not touch the power switch with wet hands.

There is risk of fire, electric shock, explosion, or injury.

When the product is soaked (flooded or submerged), contact an Authorized Service Center.

There is risk of fire or electric shock.

Be cautious not to touch the sharp edges when installing.

It may cause injury.

Take care to ensure that nobody could step on or fall onto the outdoor unit.

This could result in personal injury and product damage.

Do not open the inlet grille of the product uring operation. (Do not touch the electrostatic filter, if the unit is so equipped.)

There is risk of physical injury, electric shock, or product failure.



◆ Installation

Always check for gas (refrigerant) leakage after installation or repair of product.

Low refrigerant levels may cause failure of product.

Do not install the product where the noise or hot air from the outdoor unit could damage the neighborhoods.

It may cause a problem for your neighbors.

Keep level even when installing the product.

To avoid vibration or water leakage.

Do not install the unit where combustible gas may leak.

If the gas leaks and accumulates around the unit, an explosion may result.

Use power cables of sufficient current carrying capacity and rating.

Cables that are too small may leak, generate heat, and cause a fire.

Do not use the product for special purposes, such as preserving foods, works of art, etc. It is a consumer air conditioner, not a precision refrigeration system.

There is risk of damage or loss of property.

Keep the unit away from children. The heat exchanger is very sharp.

It can cause the injury, such as cutting the finger. Also the damaged fin may result in degradation of capacity.

When installing the unit in a hospital, communication station, or similar place, provide sufficient protection against noise.

The inverter equipment, private power generator, high-frequency medical equipment, or radio communication equipment may cause the air conditioner to operate erroneously, or fail to operate. On the other hand, the air conditioner may affect such equipment by creating noise that disturbs medical treatment or image broadcasting.

Do not install the product where it is exposed to sea wind (salt spray) directly.

It may cause corrosion on the product. Corrosion, particularly on the condenser and evaporator fins, could cause product malfunction or inefficient operation.

◆ Operation

Do not use the air conditioner in special environments.

Oil, steam, sulfuric smoke, etc. can significantly reduce the performance of the air conditioner or damage its parts.

Do not block the inlet or outlet.

It may cause failure of appliance or accident.

Make the connections securely so that the outside force of the cable may not be applied to the terminals.

Inadequate connection and fastening may generate heat and cause a fire.

Be sure the installation area does not deteriorate with age.

If the base collapses, the air conditioner could fall with it, causing property damage, product failure, or personal injury.

Install and insulate the drain hose to ensure that water is drained away properly based on the installation manual.

A bad connection may cause water leakage.

Safely dispose of the packing materials.

Packing materials, such as nails and other metal or wooden parts, may cause stabs or other injuries. • Tear apart and throw away plastic packaging bags so that children may not play with them. If children play with a plastic bag which was not torn apart, they face the risk of suffocation.

Turn on the power at least 8 hours before starting operation.

Starting operation immediately after turning on the main power switch can result in severe damage to internal parts. Keep the power switch turned on during the operational season.

Be very careful about product transportation.

Only one person should not carry the product if it weighs more than 44lbs (20kg).

Some products use PP bands for packaging. Do not use any PP bands for a means of transportation. It is dangerous.

Do not touch the heat exchanger fins. Doing so may cut your fingers.

When transporting the outdoor unit, suspend it at the specified positions on the unit base. Also support the outdoor unit at four points so that it cannot slip sideways.

Do not touch any of the refrigerant piping during and after operation.

It can cause a burn or frostbite.

Do not operate the air conditioner with the panels or guards removed.

Rotating, hot, or high-voltage parts can cause injuries.

Do not directly turn off the main power switch after stopping operation.

Wait at least 5 minutes before turning off the main power switch. Otherwise it may result in water leakage or other problems.

Auto-addressing should be done in condition of connecting the power of all indoor and outdoor units. Auto-addressing should also be done in case of changing the indoor unit PCB. Use a firm stool or ladder when cleaning or maintaining the air conditioner.

Be careful and avoid personal injury.

Do not insert hands or other objects through the air inlet or outlet while the air conditioner is plugged in.

There are sharp and moving parts that could cause personal injury.

CHAPTER 1 INTRODUCTION TO BASIC FEATURES OF UNITS

CHAPTER 1 INTRODUCTION TO BASIC FEATURES OF UNITS

1 BASIC OPERATING PRINCIPLE

The operating principle is as follows: When an indoor unit (IDU) is operating in cooling mode, the outdoor unit (ODU) can correspondingly enable the outdoor module based on the operating load requirement of the IDU. The outdoor heat exchanger serves as a system condenser, and the heat exchangers of cooling IDUs are connected in parallel to serve as a system evaporator. The circulation of air supply and air return of the IDU is performed to adjust the indoor temperature and humidity. When an IDU is operating in heating mode, all four-way valves in the ODU module are switched into energized status. The outdoor heat exchange serves as the system evaporator, and the heat exchanger of the IDU serves as the system condenser. The circulation of air supply and air return of the IDU is performed to adjust the indoor temperature and humidity.

MODELS LIST:

Model Name	Product Code	Power Supply (V, Ph, Hz)	Appearance
GMV-VQ72W/A-F(U)	CN851W1730	208/230V 3ph 60Hz	
GMV-VQ96W/A-F(U)	CN851W1740	208/230V 3ph 60Hz	
GMV-VQ144WM/A-F(U)		208/230V 3ph 60Hz	
GMV-VQ168WM/A-F(U)		208/230V 3ph 60Hz	
GMV-VQ192WM/A-F(U)		208/230V 3ph 60Hz	
NCHS1B(U)	EN04001120	208/230V 1Ph 60Hz	
NCHS2B(U)	EN01600010	208/230V 1Ph 60Hz	
NCHS4B(U)	EN04001130	208/230V 1Ph 60Hz	
NCHS8B(U)	EN04001140	208/230V 1Ph 60Hz	

2 INTERNAL PIPING DESIGN OF THE UNITS

2.1 Piping Design of ODU

2.1.1 Piping diagram of GMV-VQ72W/A-F(U)、GMV-VQ96W/A-F(U)

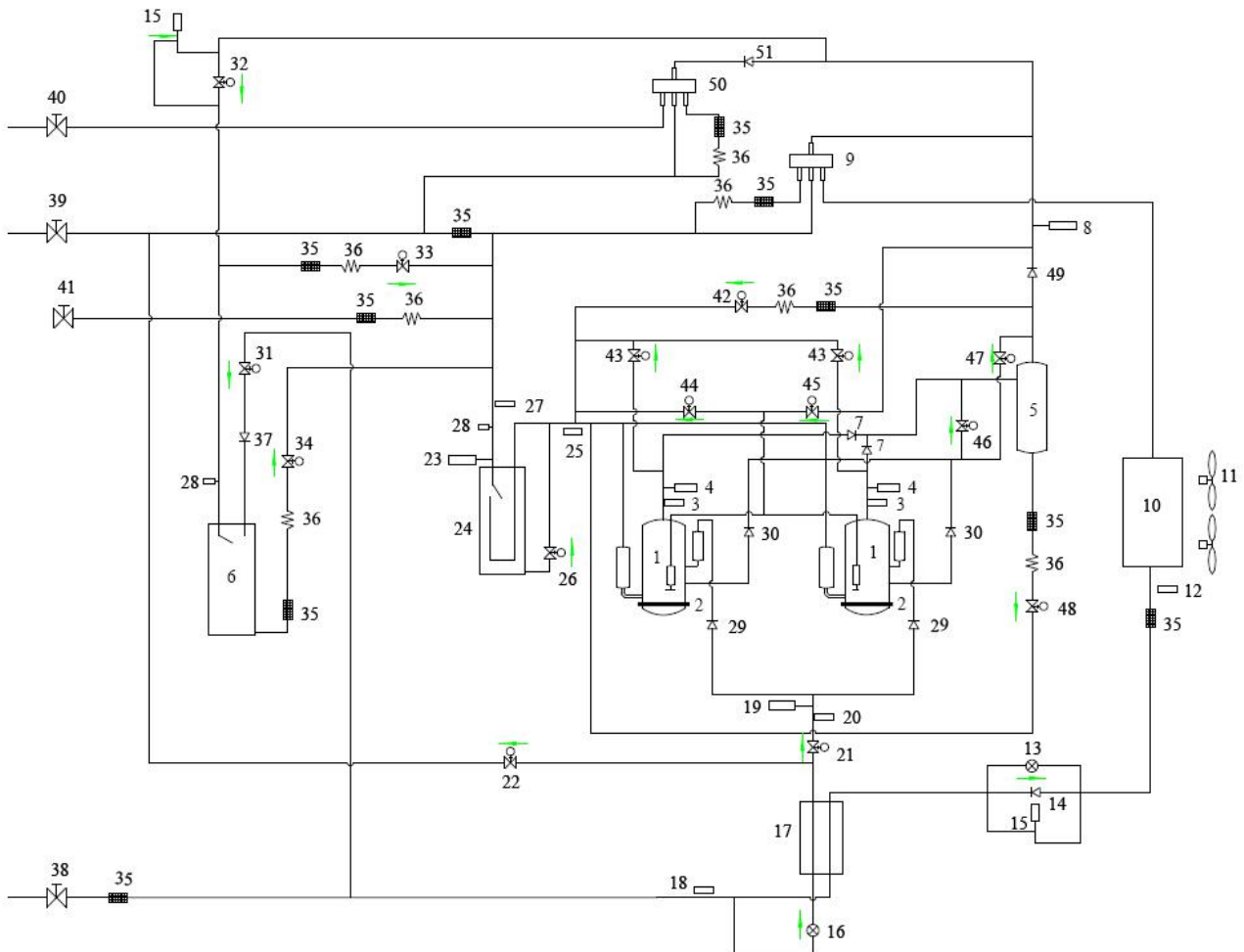

2.1.2 Piping diagram of GMV-VQ144WM/A-F(U), GMV-VQ168WM/A-F(U), GMV-VQ192WM/A-F(U)

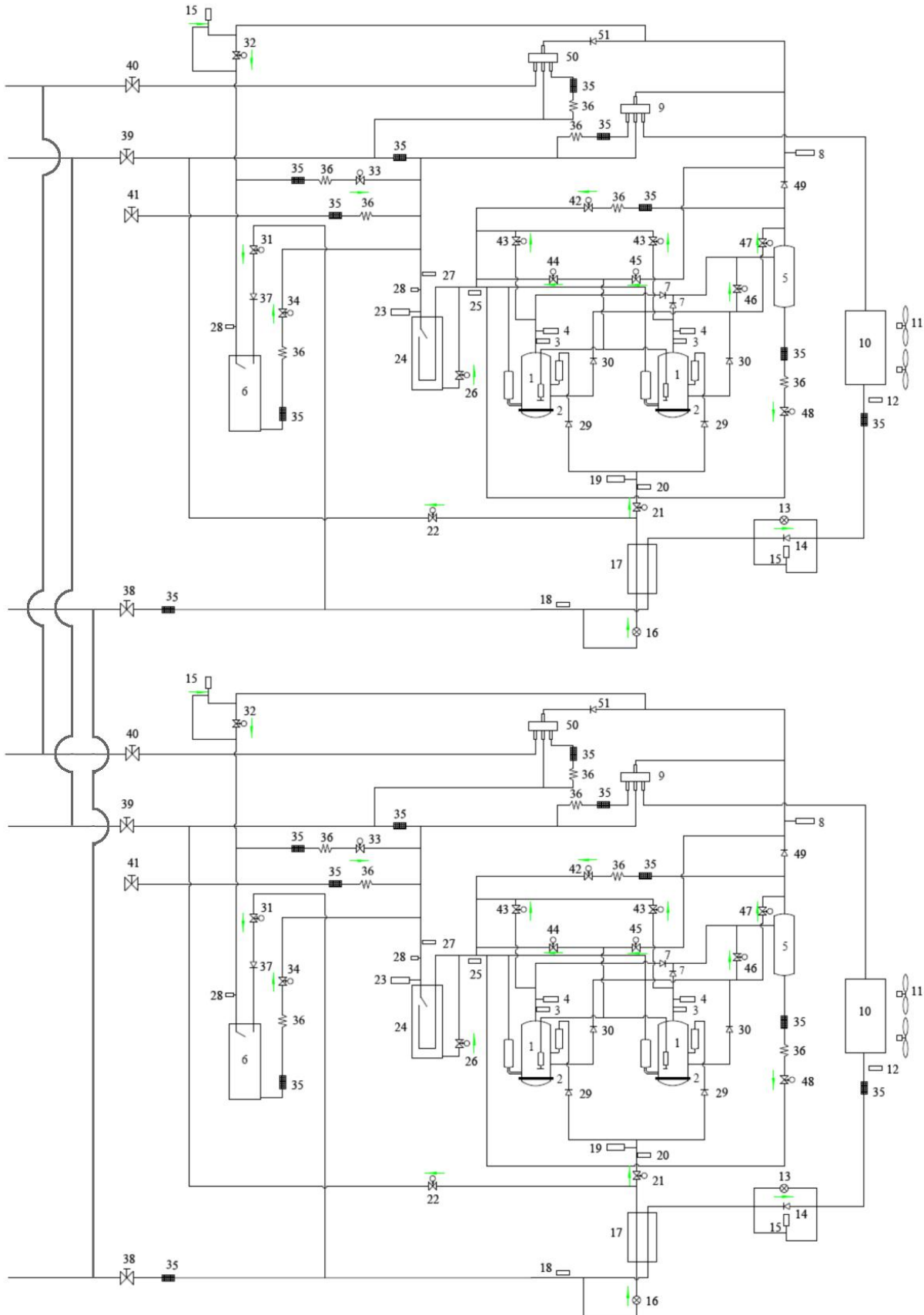

2.1.3 Names and main functions of components

No.	Name	Main Function
1	Compressor	Adjusts its own rotational speed based on the actual requirement of the system to implement capacity control.
2	Compressor heat tape	Maintains a proper oil temperature in the compressor when the compressor is in standby status, ensuring the reliability during compressor startup.
3	Exhaust pipe temperature sensor of compressor	Detects a compressor's exhaust gas temperature for compressor control and protection.
4	High-pressure circuit breaker	Protects a compressor by sending feedback signal to stop the system when the compressor's discharge pressure exceeds the operating value of high-pressure circuit breaker.
5	Oil extractor	Separates the gas and oil in the system to ensure compressor reliability.
6	Accumulator	Refrigerant adjustment.
7	One-way valve	Prevents high-pressure gas from entering the compressor and fast balances the suction pressure and discharge pressure in a compressor.
8	High-pressure sensor	Detects the high pressure value in the system in real time mode for compressor protection and other control functions.
9	Four-way valve 1	Used for the switching between the cooling and heating functions of system IDU.
10	Heat exchanger	Used for outdoor heat exchange.
11	Fan	Strengthens heat exchanging.
12	Defrosting temperature sensor	Used for defrosting detection.
13	Electronic expansion valve for heating	Controls refrigerant adjustment in heating mode.
14	One-way valve	Controls refrigerant flow direction.
15	Unloading valve	Opening if the pressure inside the liquid pipe /gas pipe is too high.
16	Sub cooler electronic expansion valve	Reduces the pressure and temperature of ramous refrigerant to cool the main branch refrigerant.
17	Sub cooler	Controls the degree of sub cooling of tube.
18	Liquid outlet temperature sensor of sub cooler	Detects tube temperature.
19	Middle-pressure sensor	Detects system middle pressure.
20	Gas outlet temperature sensor of sub cooler	Detects gas temperature of sub cooler.
21	Compensate vapor valve	Used for compensating vapor for second compression.
22	Sub-cooling valve	Used for providing with sub-cooling liquid.
23	Low-pressure sensor	Detects system low pressure to avoid extra-low operating pressure.
24	Gas-liquid separator	Separate gas and liquid to prevent the system from running when the refrigerant flows back to the compressor.
25	Outlet temperature sensor of gas-liquid separator	Detects internal status of gas-liquid separator to further control the compressor suction performance.
26	Oil return valve 1	Oil return control for the compressor.

27	Inlet temperature sensor of gas-liquid separator	Detects inlet temperature of gas-liquid separator.
28	Fusible plug	Opening if the pressure or the temperature inside the accumulator or liquid-gas separator is too high.
29	One-way valve	Controls refrigerant flow direction.
30	One-way valve	Controls refrigerant flow direction.
31	Liquid intake valve	Liquid intake control valve for refrigerant adjustment tank.
32	Pressure valve	Pressure control valve for refrigerant adjustment tank.
33	Pressure balance valve	Press control valve inside the refrigerant adjustment tank.
34	Drain valve for cooling	Drainage control valve for cooling of refrigerant adjustment tank.
35	Filter	Prevents impurities from entering components and parts.
36	Capillary tube	Supports flow regulating and pressure reduction.
37	One-way valve	Avoid impurities getting into the electric parts. Meanwhile, absorb the water inside the liquid status to prevent ice blockage.
38	Liquid valve	Stop valve, closed when the unit is delivered from the factory and will be opened after installation.
39	Low pressure gas pipe valve	Stop valve, closed when the unit is delivered from the factory and will be opened after installation.
40	High pressure gas pipe valve	Stop valve, closed when the unit is delivered from the factory and will be opened after installation.
41	Low-pressure measurement valve	Detects the low pressure value or charges refrigerant during system running.
42	Gas-bypass valve	Make sure pressure of the system is balanced.
43	Pressure-balanced valve	Ensures success startup of compressor.
44	Varying capacity valve 1	To make the compressor turn with double cylinders.
45	Varying capacity valve 2	To make the compressor turn with triple cylinders.
46	Oil-balanced valve 1	Make sure oil of the system is balanced.
47	Oil-balanced valve 2	Make sure oil of the modules is balanced.
48	Oil return valve	Oil return control for the compressor.
49	One-way valve	Prevents high-pressure gas from entering the compressor and fast balances the suction pressure and discharge pressure in a compressor.
50	Four-way valve 2	Used for the switching between the cooling and heating functions of system IDU.
51	One-way valve	Controls refrigerant flow direction.

2.2 Piping Design of C&H Mode Exchanger

2.2.1 Piping diagram

NCHS1B(U):

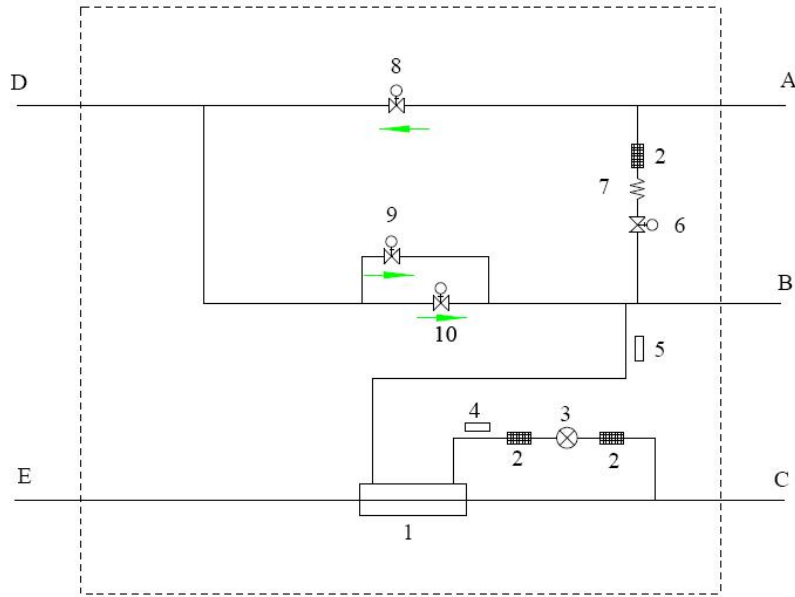

NCHS2B(U):

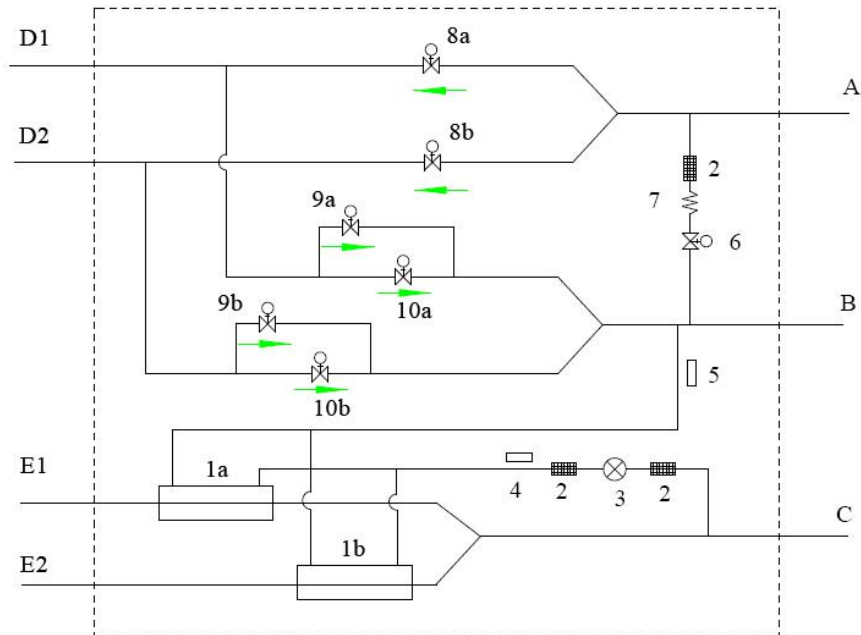

The piping diagram of NCHS4B(U) and NCHS8B(U) is similar to the piping diagram of NCHS2B(U), which have 4 or 8 branches of liquid pipes and gas pipes connecting with IDUs.

2.2.2 Names and main functions of components

No.	Name	Main Function
1	Sub cooler	Controls the degree of sub cooling of tube. (For example, 1a is the sub cooler of IDU1)
2	Filter	Prevents impurities from entering components and parts.

3	Sub cooler electronic expansion valve	Controls the degree of sub cooling of tube refrigerant.
4	Gas inlet temperature sensor of sub cooler	Detects gas tube temperature before inflowing to sub cooler.
5	Gas outlet temperature sensor of sub cooler	Detects outflow gas temperature of sub cooler.
6	Gas-bypass valve	Make sure pressure of the system is balanced.
7	Capillary tube	Supports flow regulating and pressure reduction.
8	High pressure gas valve	Controls the refrigerant flow when IDU is heating. (For example, 8a is the high pressure gas valve of IDU1)
9	Gas-bypass valve	Make sure pressure of the system is balanced. (For example, 9a is the gas-bypass valve of IDU1)
10	Low pressure gas valve	Controls the refrigerant flow when IDU is cooling.
A	High pressure gas pipe	Connects with ODU high pressure gas pipe.
B	Low pressure gas pipe	Connects with ODU low pressure gas pipe.
C	Liquid pipe	Connects with ODU liquid pipe.
D	Gas pipe(with IDU)	Connects with IDU gas pipe. (For example, D1 means connecting with gas pipe of IDU1)
E	Liquid pipe(with IDU)	Connects with IDU liquid pipe. (For example, E1 means connecting with liquid pipe of IDU1)

3 BASIC PARAMETERS OF UNIT

3.1 Basic Parameters of ODU

Outdoor Units_Heat Recovery		Ton	6	8	12	14	16
Model		-	GMV-VQ7 2W/A-F(U)	GMV-VQ9 6W/A-F(U)	GMV-VQ1 44WM/A-F (U)	GMV-VQ1 68WM/A-F (U)	GMV-VQ19 2WM/A-F(U)
Module Combination		-	GMV-VQ7 2W/A-F(U)	GMV-VQ9 6W/A-F(U)	GMV-VQ7 2W/A-F(U) +GMV-VQ 72W/A-F(U)	GMV-VQ7 2W/A-F(U) +GMV-VQ 96W/A-F(U)	GMV-VQ96 W/A-F(U)+ GMV-VQ96 W/A-F(U)
Performance	Nominal Cooling Capacity	KBtu/h	72	96	144	168	192
		kW	21.1	28.1	42.2	49.2	56.3
	Rated Cooling Capacity①	KBtu/h	69	92	138	160	184
		kW	20.22	26.96	40.45	46.89	53.93
	Nominal Heating Capacity	KBtu/h	81	108	162	189	216
		kW	23.7	31.6	47.4	55.3	63.3
	Rated Heating Capacity	KBtu/h	77	103	154	180	200
		kW	22.57	30.19	45.13	52.76	58.62
	Cooling Power Input	kW	6.10	8.36	12.58	14.79	17.36
	Heating Power Input	kW	6.64	8.88	13.67	16.25	18.03

Outdoor Units_Heat Recovery		Ton	6	8	12	14	16
Model		-	GMV-VQ7 2W/A-F(U)	GMV-VQ9 6W/A-F(U)	GMV-VQ1 44WM/A-F (U)	GMV-VQ1 68WM/A-F (U)	GMV-VQ19 2WM/A-F(U)
Module Combination		-	GMV-VQ7 2W/A-F(U)	GMV-VQ9 6W/A-F(U)	GMV-VQ7 2W/A-F(U) +GMV-VQ 72W/A-F(U)	GMV-VQ7 2W/A-F(U) +GMV-VQ 96W/A-F(U)	GMV-VQ96 W/A-F(U)+ GMV-VQ96 W/A-F(U)
	Sound Pressure Level	dB(A)	60	60	/	/	/
	Power Supply	-	208/230V 3~ 60HZ				
Compressor	Type	-	Inverter Rotary	Inverter Rotary	Inverter Rotary	Inverter Rotary	Inverter Rotary
	Number	N	2	2	2+2	2+2	2+2
	Motor Input②	kW	5.83×2	5.83×2	5.83×2+5.8 3×2	5.83×2+5.8 3×2	5.83×2+5.8 3×2
	Starting Method	-	Inverter	Inverter	Inverter	Inverter	Inverter
	Operating Range	-	10%~100%	10%~100%	10%~100%	10%~100%	10%~100%
	Refrigeration Oil Brand	-	FV50S	FV50S	FV50S	FV50S	FV50S
	Oil Charge	Compressor	L	1.35×2	1.35×2	1.35× 2+1.35×2	1.35× 2+1.35×2
Oil Separate Tank		L	6	6	6+6	6+6	6+6
Total		L	8.7	8.7	8.7+8.7	8.7+8.7	8.7+8.7
Fan	Type×Quantity	-	Propeller×2	Propeller×2	Propeller×(2+2)	Propeller×(2+2)	Propeller×(2+2)
	Motor Output	W	750+750	750+750	750×2+750 ×2	750×2+750 ×2	750×2+750 ×2
	Starting Method	-	Inverter	Inverter	Inverter	Inverter	Inverter
	Air Flow Rate	m3/h	14000	14000	27970	27970	27970
		cfm	8239	8239	16460	16460	16460
	Max. External Static Pressure	Pa	82	82	82	82	82
in.W.G		0.328	0.328	0.328	0.328	0.328	
Ambient Temperature Range	Cooling	℃	-10~52	-10~52	-10~52	-10~52	-10~52
		℉	14~125.6	14~125.6	14~125.6	14~125.6	14~125.6
	Heating	℃	-30~24	-30~24	-30~24	-30~24	-30~24
		℉	-22~75.2	-22~75.2	-22~75.2	-22~75.2	-22~75.2
Refrigerant	Type	-	R410A	R410A	R410A	R410A	R410A
	Charge Volume	kg	12.5	12.5	25	25	25
		lbs.	27.6	27.6	55.1	55.1	55.1
	Control	-	EEV	EEV	EEV	EEV	EEV

Outdoor Units_Heat Recovery		Ton	6	8	12	14	16	
Model		-	GMV-VQ7 2W/A-F(U)	GMV-VQ9 6W/A-F(U)	GMV-VQ1 44WM/A-F (U)	GMV-VQ1 68WM/A-F (U)	GMV-VQ19 2WM/A-F(U)	
Module Combination		-	GMV-VQ7 2W/A-F(U)	GMV-VQ9 6W/A-F(U)	GMV-VQ7 2W/A-F(U) +GMV-VQ 72W/A-F(U)	GMV-VQ7 2W/A-F(U) +GMV-VQ 96W/A-F(U)	GMV-VQ96 W/A-F(U)+ GMV-VQ96 W/A-F(U)	
Pipe Connection	Low Pressure Gas Pipe	mm	28.6	28.6	34.9	34.9	34.9	
		in.	1-1/8	1-1/8	1-3/8	1-3/8	1-3/8	
	High Pressure Gas Pipe	mm	19.05	19.05	28.6	28.6	28.6	
		in.	3/4	3/4	1-1/8	1-1/8	1-1/8	
	Liquid Pipe Size	mm	12.7	12.7	15.9	15.9	15.9	
		in.	1/2	1/2	5/8	5/8	5/8	
Dimensions (width×dept h×height)	External Dimension	mm	1340×765× 1605	1340×765× 1605	1340×765× 1605+ 1340×765× 1605	1340×765× 1605+ 1340×765× 1605	1340×765× 1605+ 1340×765× 1605	
		in.	52-3/4×30- 1/9×63-1/5	52-3/4×30- 1/9×63-1/5	52-3/4×30- 1/9×63-1/5 + 52-3/4×30- 1/9×63-1/5	52-3/4×30- 1/9×63-1/5 + 52-3/4×30- 1/9×63-1/5	52-3/4×30- 1/9×63-1/5 + 52-3/4×30- 1/9×63-1/5	
	Packaging Dimension	mm	1420×840× 1775	1420×840× 1775	1420×840× 1775+ 1420×840× 1775	1420×840× 1775+ 1420×840× 1775	1420×840× 1775+ 1420×840× 1775	
		in.	55-8/9×33- 1/9×69-7/8	55-8/9×33- 1/9×69-7/8	55-8/9×33- 1/9×69-7/8 + 55-8/9×33- 1/9×69-7/8	55-8/9×33- 1/9×69-7/8 + 55-8/9×33- 1/9×69-7/8	55-8/9×33- 1/9×69-7/8 + 55-8/9×33- 1/9×69-7/8	
	Weight	Net Weight	kg	408	408	408+408	408+408	408+408
			lbs.	899.6	899.6	1799.3	1799.3	1799.3
Gross Weight		kg	423	423	846	846	846	
		lbs.	932.7	932.7	1865.4	1865.4	1865.4	
Maximum Quantity of Connected Indoor Unit		unit	12	17	24	29	34	
Protection Devices	High Pressure Protection	-	High pressure sensor, high pressure switch					
	Compressor/Fan	-	Over-current protection, over-heat protection					
	Inverter	-	Over-current protection					

Outdoor Units_Heat Recovery	Ton	6	8	12	14	16
Model	-	GMV-VQ7 2W/A-F(U)	GMV-VQ9 6W/A-F(U)	GMV-VQ1 44WM/A-F (U)	GMV-VQ1 68WM/A-F (U)	GMV-VQ19 2WM/A-F(U)
Module Combination	-	GMV-VQ7 2W/A-F(U)	GMV-VQ9 6W/A-F(U)	GMV-VQ7 2W/A-F(U) +GMV-VQ 72W/A-F(U)	GMV-VQ7 2W/A-F(U) +GMV-VQ 96W/A-F(U)	GMV-VQ96 W/A-F(U)+ GMV-VQ96 W/A-F(U)
Remark	<p>1. Rating conditions: Cooling: Indoor 26.7°C(80.1°F)DB/19.4°C(66.9°F)WB, Outdoor 35°C(95°F)DB/23.9°C(75°F)WB Heating: Indoor 21.1°C(70°F)DB/15°C(59°F)WB, Outdoor 8.3°C(46.9°F)DB/6.1°C(43°F)WB</p> <p>2. It refers to the operation power of compressor under ARI test conditions (condensing temp.130°F, evaporating temp.45°F, return gas temp.65°F, liquid temp.115°F) at 60HZ.</p> <p>3. Oil charge includes the total oil amount of outdoor units, residual oil amount of compressor and oil separate tank. When replacing the compressor or oil separate tank, only the corresponding required oil amount shall be charged.</p>					

3.2 C&H Mode Exchanger

C&H Mode Exchanger is used for connecting outdoor unit and indoor unit, and providing high pressure, low pressure and medium pressure refrigerant provided by outdoor unit for cooling or heating mode and complete the refrigerant system circulation for the purpose of adjusting indoor temperature.

- (1) C&H Mode Exchanger provides multiple branch combination forms, which can connect different kinds of lower branches. Each branch of the C&H Mode Exchanger can connect 8 indoor units at the most and the total capacity should be no more than 14kw.
- (2) C&H Mode Exchanger provides multiple branches used for connection lower indoor units. It's convenient for installation, leakage detection and maintenance.
- (3) C&H Mode Exchanger is supplied power independently, which connects indoor unit and outdoor unit with communication wire. It's convenient and flexible for installation and construction.

One-to-one Mode Exchanger NCHS1B(U)



One-to-two Mode Exchanger NCHS2B(U)



One-to-four Mode Exchanger NCHS4B(U)



One-to-eight Mode Exchanger NCHS8B(U)



Model		NCHS1B(U)	NCHS2B(U)	NCHS4B(U)	NCHS8B(U)	
Max. IDU Branches	/	1	2	4	8	
No. of connectable IDU of each branch	/	8	8	8	8	
Total Connectable IDU	/	8	16	32	64	
Max. Capacity of each branch	kW	14	14	14	14	
	KBtu/h	48.0	48.0	48.0	48.0	
Max. Capacity of connectable IDU	kW	14	28	45	68	
	KBtu/h	48.0	96.0	153	232	
Power supply	V/Ph/Hz	208/230V 1Ph 60Hz				
Power consumption	W	8	20	32	80	
Outdoor Unit Piping Connection	Liquid	mm	9.52	9.52	12.7	15.9
		In.	3/8	3/8	1/2	5/8
	Gas(Low pressure)	mm	22.2	22.2	28.6	28.6
		In.	7/8	7/8	1 1/8	1 1/8
	Gas(High pressure)	mm	15.9	19.05	19.05	22.2
		In.	5/8	3/4	3/4	7/8
Indoor Unit Piping Connection	Liquid	mm	9.52	9.52	9.52	9.52
		In.	3/8	3/8	3/8	3/8
	Gas	mm	15.9	15.9	15.9	15.9
		In.	5/8	5/8	5/8	5/8

3.3 Combination Mode

Model	Combined Model
GMV-VQ144WM/A-F(U)	GMV-VQ72W/A-F(U)+GMV-VQ72W/A-F(U)
GMV-VQ168WM/A-F(U)	GMV-VQ72W/A-F(U)+GMV-VQ96W/A-F(U)
GMV-VQ192WM/A-F(U)	GMV-VQ96W/A-F(U)+GMV-VQ96W/A-F(U)

▲ CAUTION

No matter how many outdoor units there are, the total rated capacity of indoor units must not exceed 135% of the total rated capacity of outdoor units. Stable and safe operation can only be guaranteed in a range of 50%~135%.

4 ELECTRICAL PARAMETERS

4.1 Power Cable Wire Gauge and Circuit Breaker Selection of ODU

Outdoor units	Power Supply	Fuse Capacity	MCA	MOP
	V/ Ph /Hz	A	A	A
GMV-VQ72W/A-F(U)	208V/230V 3~ 60Hz	50	40	50
GMV-VQ96W/A-F(U)	208V/230V 3~ 60Hz	60	45	60
GMV-VQ144WM/A-F(U)	208V/230V 3~ 60Hz	50+50	40+40	50+50
GMV-VQ168WM/A-F(U)	208V/230V 3~ 60Hz	50+60	40+45	50+60
GMV-VQ192WM/A-F(U)	208V/230V 3~ 60Hz	60+60	45+45	60+60

Note: MCA: Minimum Circuit Ampacity; MOP: Maximum Overcurrent Protection.

▲WARNING

- Power cable wire gauge and circuit breaker must be selected based on the above parameters and in compliance with local safety requirements. If there is conflict between above parameters and national requirements, please contact the manufacture promptly.
- If power cable wire gauge and circuit breaker is out of the above design range, fire hazard may occur.

4.2 Circuit Diagram of ODU

The actual wiring should always refer to the wiring diagram of the unit.

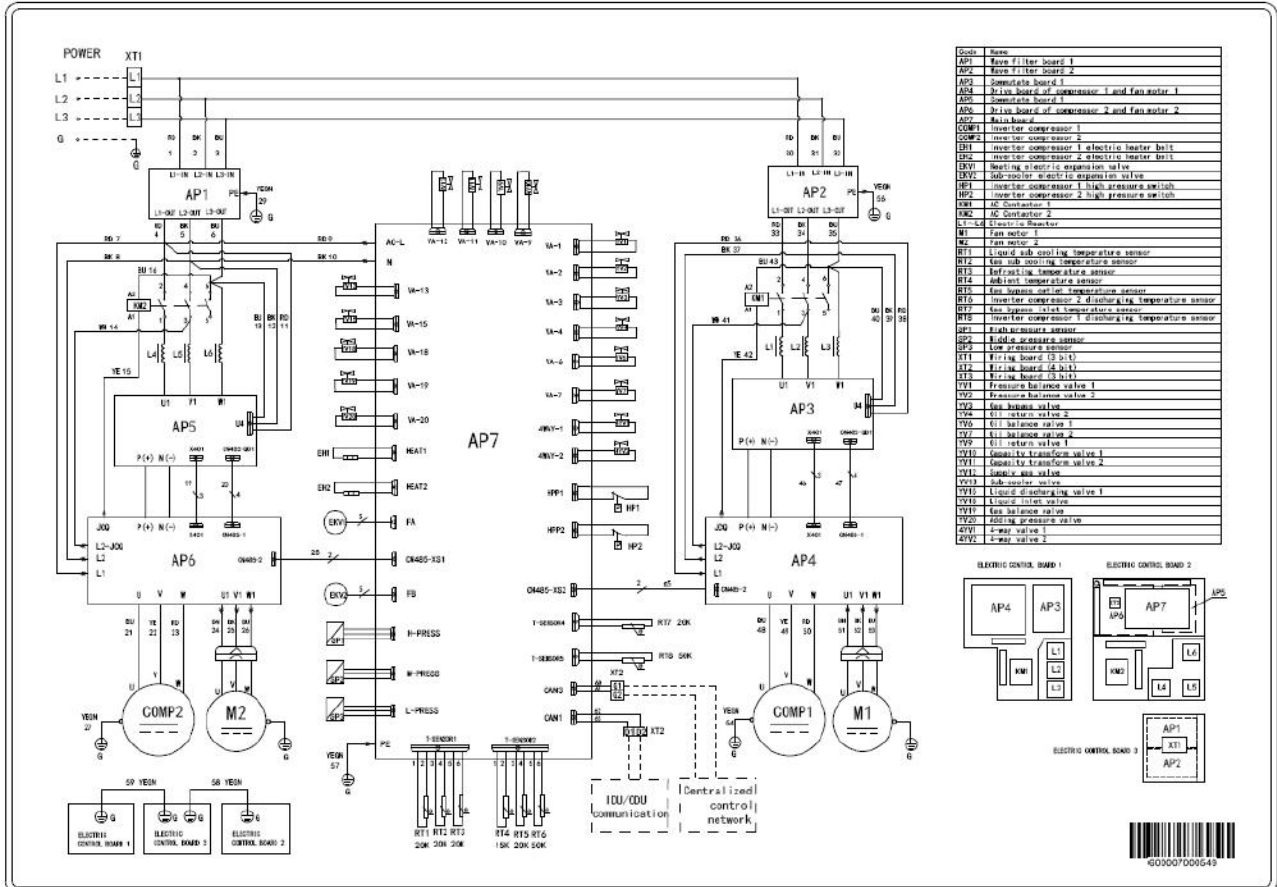

▲WARNING

When conducting maintenance based on above circuit diagrams, units must be power-off. Please strictly following the circuit diagrams when reconnecting the wires, otherwise, electric shock may occur.

5 OPTIONAL ACCESSORIES

Ultra Heat GMV series VRF units support the following optional accessories:

		Export Model	Remark
Manifold	ODU	ML01R	For model selection, refer to Pipe Selection.
	Mode Exchanger	FQ01Na/A, FQ02Na/A, FQ03Na/A, FQ04Na/A, FQ05Na/A, FQ06Na/A, FQ07Na/A	
	IDU	FQ01A/A	
Remote-control Receiver Board		JS05	Applicable for air-duct-type IDUs.
Commissioning Remote Controller		YV1L1	Provides the commissioning functions for function settings of IDUs.
Classic wired controller		Wired controller XK46	Applicable to the air Cassette, Floor Ceiling, Wall-Mounted indoor unit (duct-type indoor unit standard)
Wired controller for hotel		Wired controller XK79	With the access control function
Color screen wired controller		Wired controller XK55	
Smart zone controller		CE52-24/F(C)	Applicable for units that support CAN bus communication technology.
4G		IE60-33/CF2	
Debugging Software		DE40-33/A(C)	
Remote Monitoring System	Software	FE30-24/DF(B)	Applicable for units that support CAN bus communication technology.
	Gateway	ME30-24/DF(B)	

NOTICE! Contact local sales company for optional accessories.

6 BASIC REQUIREMENT FOR PIPE CONNECTION

1. Outdoor units adopt the modular combination design of individual cooling system, that is, units are connected by using pipes in parallel during installation. The tubing system used among modules includes Liquid pipes, high pressure gas pipes and low pressure gas pipes.

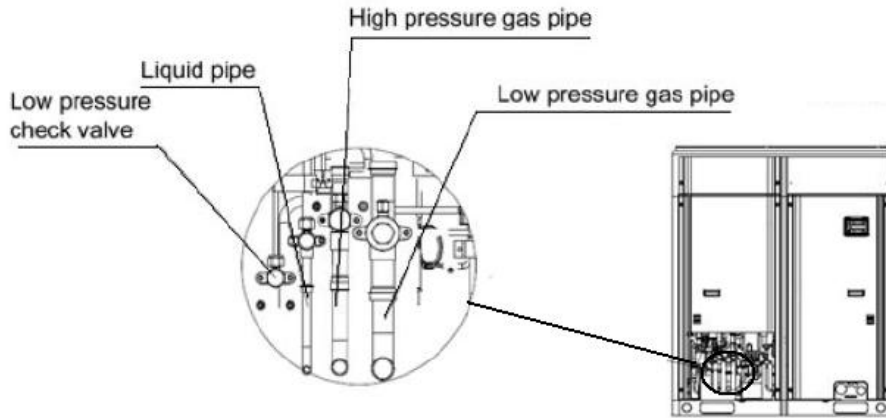

▲WARNING

- Functions of low-pressure check valve: It is mainly used for low pressure detection of the system and refrigerant charging during after-sale maintenance.

Pipe connection diagram of outdoor module:

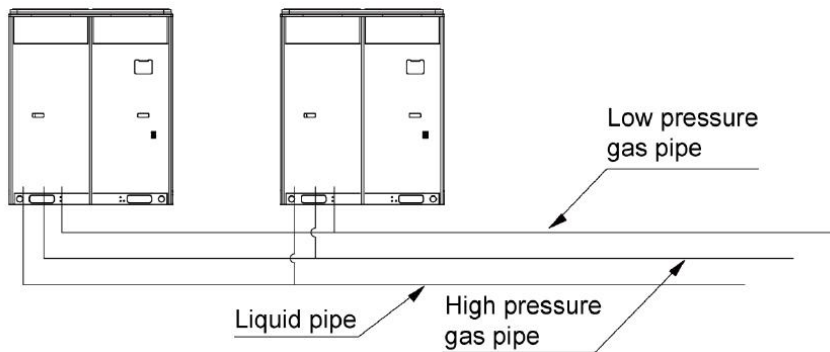

2. Each ODU system can be connected to multiple IDUs. Detailed information about the number of units to be connected and capacity ranges is shown in the following table:

Model	Maximum Number of Connected IDUs (units)	Capacity Range of Connected IDU (kBtu/h)	
		Minimum Capacity	Maximum Capacity
GMV-VQ72W/A-F(U)	12	36.0	97.2
GMV-VQ96W/A-F(U)	17	48.0	129.6
GMV-VQ144WM/A-F(U)	24	72.0	194.4
GMV-VQ168WM/A-F(U)	29	84.0	226.8
GMV-VQ192WM/A-F(U)	34	96.0	259.2

▲ CAUTION

- During installation, please strictly follow the above capacity range and number to construct, otherwise, units may work abnormally and compressors may even be damaged

7 PRECAUTIONS ON REFRIGERANT LEAKAGE

Personnel related to air conditioning engineering design and installation operators must abide by the safety requirement for preventing refrigerant leakage specified in local laws and regulations. If such safety requirement is unavailable in local documents, the design and operation must be implemented based on the following principles:

1) Ultra Heat GMV series VRF units adopt the R410A refrigerant, which is nonflammable and nontoxic. However, the space for refrigerant leakage must be sufficient to ensure that the refrigerant concentration does not exceed that specified in the safety requirement; otherwise, people involved can be stifled by the refrigerant.

The maximum refrigerant charge and maximum refrigerant concentration in the system are calculated directly based on the size of the air conditioning space. The unit of refrigerant concentration is 1 kg/m³ or 1lb/m³.

Method for calculating the maximum concentration of refrigerant:

(1) Calculate the refrigerant charge quantity of each system.

Charge quantity of an ODU upon delivery (for the system consisting of multiple modules in parallel, the accumulative charge quantity of modules upon delivery is used) + Onsite charge quantity = Total refrigerant charge quantity in the system (kg)

(2) Calculate the volume of maximum air conditioning space (m³).

Volume of air conditioning space (m³) = Length x Width x Height

Note: The length, width and height here refer to the effective length, width and height of the indoor space.

(3) Calculate the maximum refrigerant concentration of the refrigeration system.

$$\frac{\text{Total refrigerant quantity of the system}}{\text{Minimum volume of air conditioning space}} \leq \text{Maximum supported concentration}$$

Note: If the maximum supported refrigerant concentration is not available in relevant local standard, use 0.3kg /m³ (0.66lbs/m³) as the maximum supported refrigerant concentration.

2) If the maximum refrigerant concentration exceeds the allowed threshold, the refrigeration system must be redesigned. In this case, separate the refrigeration system into multiple small-capacity refrigeration systems, or add corresponding ventilation measures or alarming display.

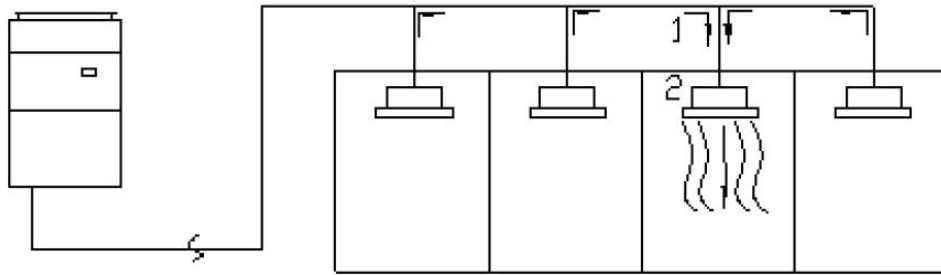

- (1) Flow direction of refrigerant leakage.
- (2) Room for refrigerant leakage. Since the concentration of refrigerant is greater than that of air, pay attention to the spaces where the refrigerant may residue, for example, the basement.

▲WARNING

If the above equation cannot be satisfied, then follow the following steps.

● **Selection of air conditioning system: select one of the next**

- (1) Installation of effective opening part
- (2) Reconfirmation of Outdoor Unit capacity and piping length
- (3) Reduction of the amount of refrigerant
- (4) Installation of 2 or more security device (alarm for gas leakage)

● **Change Indoor Unit type:**

Installation position should be over 6.6ft from the floor (Wall mounted type → Cassette type)

● **Adoption of ventilation system:**

Choose ordinary ventilation system or building ventilation system

● **Limitation in piping work:**

Prepare for earthquake and thermal stress

8 UNIT OPERATING TEMPERATURE

Cooling	Ambient temperature: -10°C(14°F)~52°C(125.6°F)
Heating	Ambient temperature: -30°C (-22°F)~24°C (75.2°F)
Heat recovery operation	Ambient temperature: -10° C(14° F)~20° C(68° F)

When the indoor units are all VRF air processor, the unit operating range is as follows:

Cooling operation	Ambient temperature: 16° C(60.8° F)~45° C(113° F)
Heating operation	Ambient temperature: -7° C(19.4° F)~16° C(60.8° F)

NOTICE! Out of the working Temperature Range may damage this products and will invalidate the warranty.

Electrify the unit 8 hours before operation. Please switch on for 8 hours before operation. Do not cut off the power when 24 hours short-time halting (to protect the compressor).

▲CAUTION

- If unit operates out of the above range, it may not work stably and components may even be damaged.

CHAPTER 2

INSTALLATION

CHAPTER 2 INSTALLATION

PART 1 ENGINEERING INSTALLATION PREPARATION

1 INSTALLATION SAFETY

Personnel and property safety are highly concerned during the entire installation process. Installation implementation must abide by relevant national safety regulations to ensure personnel and property safety.

All personnel involved in the installation must attend safety education courses and pass corresponding safety examinations before installation. Only qualified personnel can attend the installation. Relevant personnel must be held responsible for any violation of the regulation.

2 IMPORTANCE OF INSTALLATION ENGINEERING

VRF air conditioning systems use refrigerant, instead of other agent, to directly evaporate to carry out the system heat. High level of pipe cleanness and dryness is required in the system. Since various pipes need to be prepared and laid out onsite, carelessness or wrong operation during installation may leave impurities, water, or dust inside refrigerant pipes. If the design fails to meet the requirement, various problems may occur in the system or even lead to system breakdown.

Problems that usually occur during installation are as follows:

No.	Installation Problem	Possible Consequence
1	Dust or impurities enter into the refrigeration system.	Pipes are more likely to be blocked; air conditioning performance is reduced; compressor wear is increased or even hinder the normal operation of the system and burn the compressor.
2	Nitrogen is not filled into the refrigerant pipe or insufficient Nitrogen is filled before welding.	Pipes are more likely to be blocked; air conditioning performance is reduced; compressor wear is increased or even hinder the normal operation of the system and burn the compressor.
3	The vacuum degree in the refrigerant pipe is insufficient.	The refrigeration performance is reduced. The system fails to keep normal operation due to frequent protection measures. When the problem getting serious, compressor and other major components can be damaged.
4	Water enters into the refrigeration system.	Copper plating may appear on the compressor and reduce the compressor efficiency with abnormal noise generated; failures may occur in the system due to ice plug.
5	The refrigerant pipe specifications do not meet the configuration requirements.	Smaller configuration specifications can increase the system pipe resistance and affect the cooling performance; larger configuration specifications are waste of materials and can also reduce the cooling performance.
6	Refrigerant pipe is blocked.	The cooling performance is reduced; in certain cases, it may cause long-term compressor operating under overheat conditions; the lubricating effect can be affected and the compressor may be burnt if impurities were mixed with the lubricating oil.
7	Refrigerant pipe exceeds the limit.	The loss in pipe is considerable and the unit energy efficiency decreases, which are harmful for long-term running of the system.
8	Incorrect amount of refrigerant is filled.	The system cannot correctly control the flow allocation; the compressor may be operating under over-heating environment or running when the refrigerant flows back to the compressor.

9	The refrigerant pipe leaks.	Insufficient refrigerant circulating in the system decreases the cooling performance of the air conditioner. Long-term operation under such circumstance may cause an overheating compressor or even damage the compressor.
10	Water drainage from the condensate water pipe is not smooth.	Residual water in IDUs can affect the normal operation of the system. The possible water leakage can damage the IDU's decoration.
11	The ratio of slop for condensate water pipe is insufficient or the condensate water pipe is incorrectly connected.	Reverse slop or inconsistent connection of condensate water pipe can hinder the smooth drainage and cause leakage of the IDU.
12	The air channel is improperly fixed.	The air channel will deform; vibration and noise occur during unit operating.
13	The guide vane of air channel is not reasonably manufactured.	Uneven air quantity allocation reduces the overall performance of the air conditioner.
14	The refrigerant pipe or condensate water pipe does not meet the insulation requirement.	Water cans easily condensate and drips to damage the indoor decoration, or even trigger the protection mode of system due to overheating operation.
15	The installation space for IDU is insufficient.	Since there is a lack of space for maintenance and checking, indoor decoration might need to be damaged during such operation.
16	The IDU or the location of the air outlet or return air inlet is not designed reasonably.	The air outlet or return air inlet may be short-circuited, thus affecting the air conditioning performance.
17	The ODU is improperly installed.	The ODU is difficult to be maintained; unit exhaust is not smooth, which reduces the heat exchanging performance or even prevent the system from normal operation; in addition, the cold and hot air for heat exchange and the noise may annoy people in surrounding areas.
18	Power cables are incorrectly provided.	Unit components may be damaged and potential safety hazard may occur.
19	Control communication cables are incorrectly provided or improperly connected.	The normal communication in the system fails or the control over IDUs and ODUs turn in a mess.
20	Control communication cables are not properly protected.	The communication cables are short-circuited or disconnected, and the unit cannot be started up due to communication failure.

Understand the special requirement (if any) for unit installation before implementation to ensure installation quality. Relevant installers must have corresponding engineering construction qualifications.

Special type operators involved in the engineering implementation, such as welders, electricians, and refrigeration mechanics must have relevant operating licenses and are accredited with vocational qualification certification.

3 COOPERATION BETWEEN DIFFERENT PROFESSIONS

A quality installation of air conditioning engineering depends on careful organization and close cooperation between different professions such as architecture, structure, electric, water supply and drainage, fire-fighting, and decoration. Pipes must be laid in places away from any automatic spray head for fire-fighting, and must be reasonably arranged to ensure that the pipes fit the electric, luminaries, and decoration.

3.1 Requirements for Cooperation with Civil Engineering

- (1) The riser should be installed in the air conditioning tube well, and the horizontal pipe should be

placed in the ceiling, if possible.

(2) A place should be reserved for the ODU base to prevent the waterproof layer or insulating layer on the roof from being damaged in later phase of installation.

(3) At places on walls or floors where pipes need to go through, holes or casing should be preserved. If the pipe needs to go through a bearing beam, a steel casing must be prepared.

3.2 Requirements for Cooperation with Decoration Engineering

The air conditioning installation should not damage the bearing structure or the decorative style. Air conditioning pipes should be laid out along the bottom of the beam as possible. If pipes meet one another at the same elevation, process based on the following principles:

(1) Drain pipes enjoy the highest priority. Air ducts and pressure pipes should leave places for gravity pipes.

(2) Air ducts and small pipes should leave places for major pipes.

3.3 Requirements for Cooperation with Electric

After the capacity of air conditioning unit is determined, check the following aspects with relevant electric design personnel:

(1) Whether the electrical load is designed based on the requirement of the air conditioning unit;

(2) Whether the power cable and circuit breaker meet the unit requirement and abide by relevant national safety regulations;

(3) Whether the regional power supply quality (including voltage fluctuation and interference noise) meet the international requirement;

(4) Any nonconformity must be resolved through coordination.

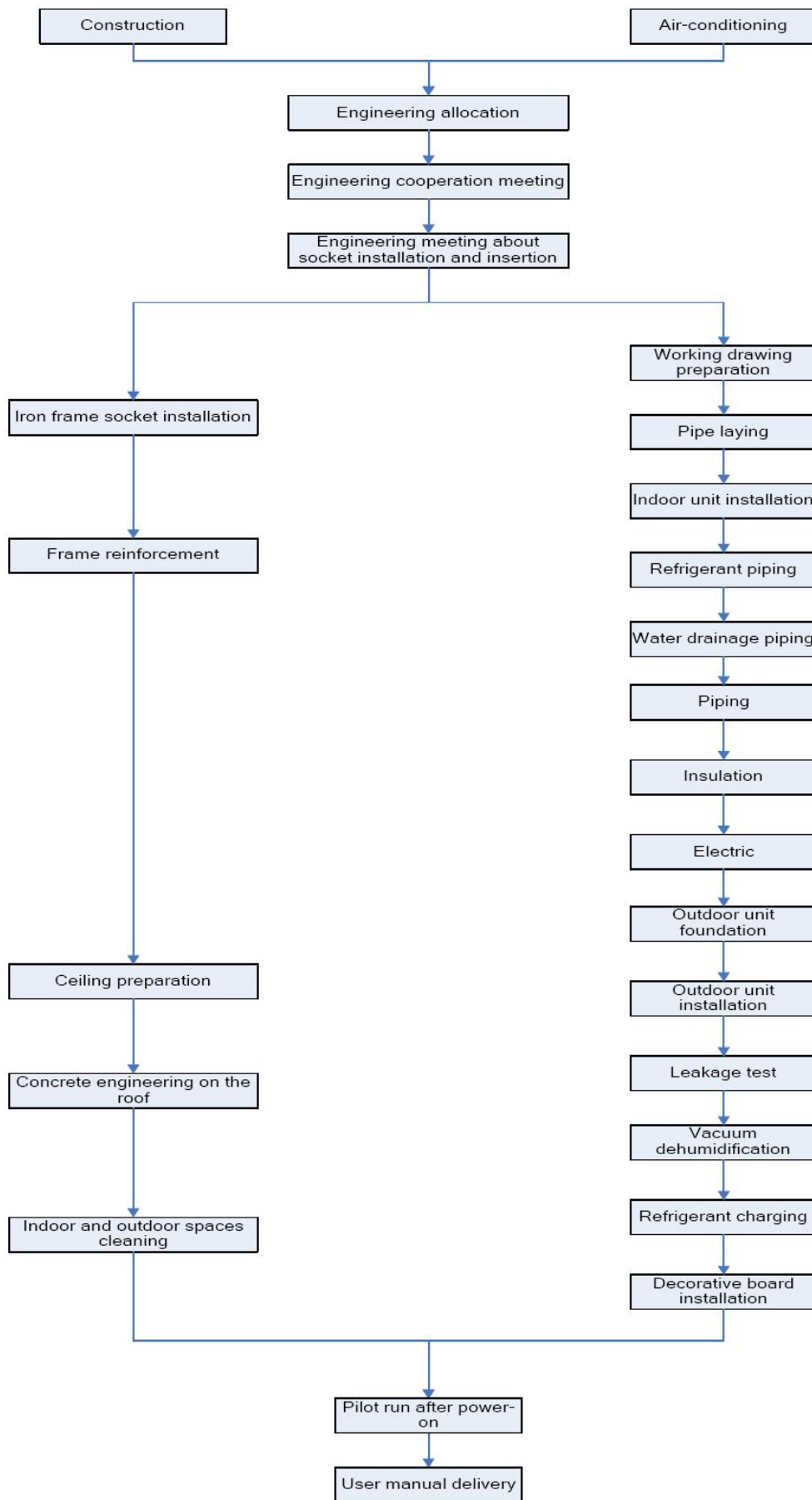

4 ONSITE REVIEW OF DESIGN DRAWING

Installation personnel must carefully read and understand the design scheme and drawings provided by engineering designers, and prepare detailed and feasible construction organization design after reviewing the onsite status.

The following aspects of working drawing must be reviewed:

(1) The loads of indoor and ODUs must match. The gross rated capacity of the IDU should be set to a value that is 50% to 135% of the rated capacity of the ODU. In actual conditions, if the capacity of concurrently operating IDUs exceeds 100% of the rated capacity of the ODU, the air conditioning system fails to meet the requirement. Note: Configuration in excess of the capacity of the IDUs can affect the comfort for users. The more the excess is, the lower the adjustment capacity of an air conditioning unit will be. The difference of level between an ODU and an IDU, and that between IDUs must be set within the designed range.

(2) The pipe diameter and manifold type in the cooling system must meet relevant technical specifications.

(3) The drainage method of unit condensate water must be reasonable; the pipeline slope must follow the design requirement of unit.

(4) The air duct direction and air flow are reasonably organized.

(5) The configuration specifications, type, and control method of power cables should meet the design requirement of unit.

(6) The arrangement, total length, and control method of control line should meet the design requirement of unit.

NOTE: Engineering construction personnel must strictly abide by the design drawings. If any design cannot be implemented during construction and needs to be modified, contact the designer first for approval and prepare a written document, that is, the design modification record.

5 CONSTRUCTION ORGANIZATION PROCESS

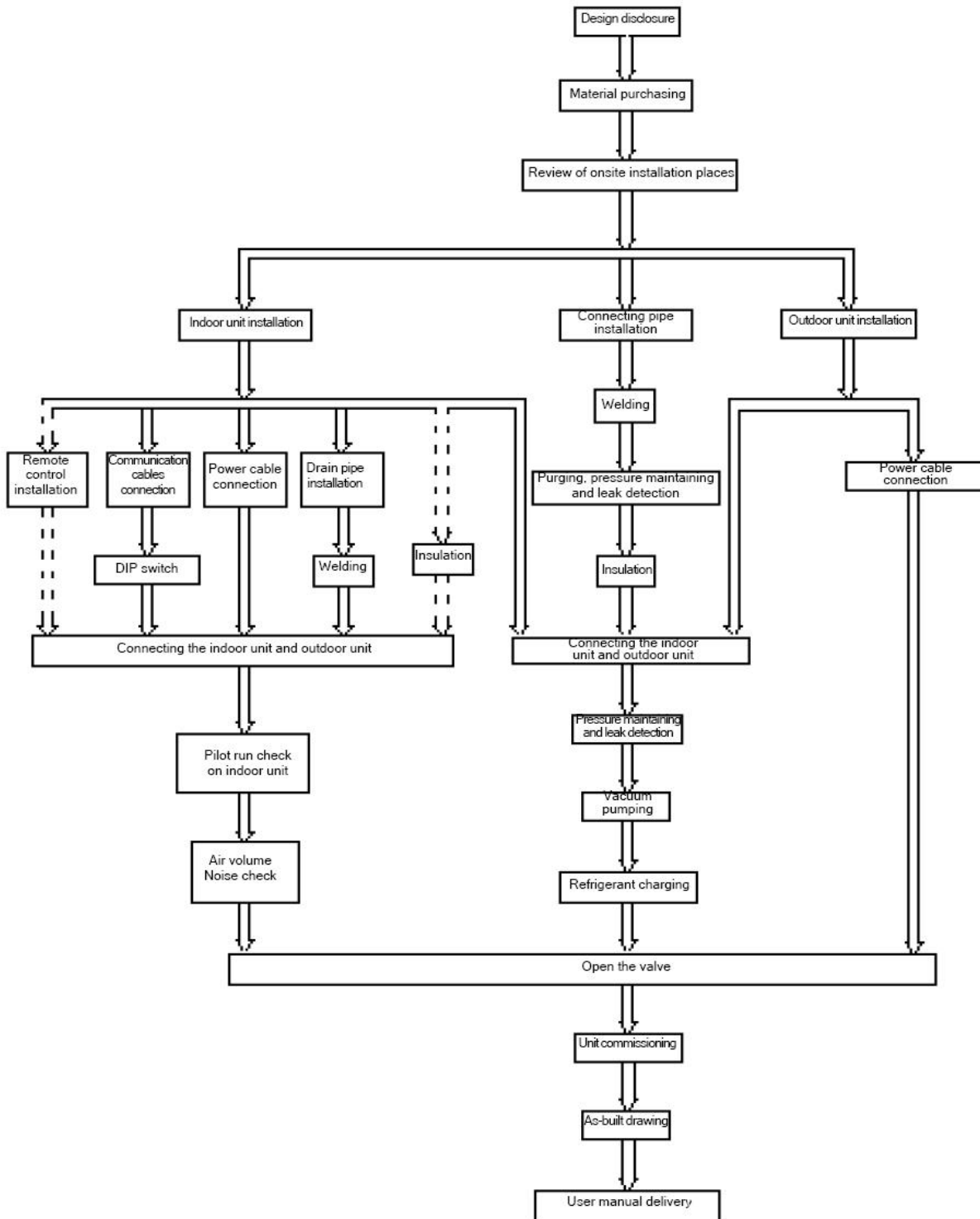

CAUTION

Above process is a general operation process, which can be adjusted in practice according to local requirements.

PART 2 MATERIAL SELECTIONS

1 REQUIREMENT FOR SELECTING CONSTRUCTION MATERIALS

The materials, equipment and instruments used during air conditioning engineering construction must have certifications and test reports.

Products with fireproof requirements must be provided with fireproof inspection certificates and must meet national and relevant compulsory standards.

If environmentally-friendly materials are to be used as required by customers, all such materials must meet national environmental protection requirement and be provided with relevant certificates.

2 REQUIREMENT FOR SELECTING MAJOR MATERIALS

2.1 Copper Pipe

R410A Refrigeration System		
Outer diameter (mm/inch)	Wall thickness (mm)	Type
Φ6.35(1/4)	≥0.8	0
Φ9.52(3/8)	≥0.8	0
Φ12.70(1/2)	≥0.8	0
Φ15.9(5/8)	≥1.0	0
Φ19.05(3/4)	≥1.0	0
Φ22.2(7/8)	≥1.2	1/2H
Φ25.40(1/1)	≥1.2	1/2H
Φ28.60(9/8)	≥1.2	1/2H
Φ31.80(5/4)	≥1.3	1/2H
Φ34.90(11/8)	≥1.3	1/2H
Φ38.10(12/8)	≥1.5	1/2H
Φ41.30(13/8)	≥1.5	1/2H
Φ44.5(7/4)	≥1.5	1/2H
Φ51.4(7/4)	≥1.5	1/2H
Φ54.1(17/8)	≥1.5	1/2H

After the inner part of the copper pipe is cleaned and dried, the inlet and outlet must be sealed tightly by using pipe caps, plugs or adhesive tapes.

2.2 Communication Cable and Control Cable

For air conditioning units installed in places with strong electromagnetic interference, shielded wire must be used as the communication cables of the IDU and wired controller, and shielded twisted pairs must be used as the communication cables between IDUs and between the IDU and ODU.

- (1) Selection for the communication cables of outdoor unit and indoor unit:

Material Type	Total Length L(m) of Communication Cable between IDU Unit and IDU (ODU) Unit m(feet)	Wire size	Remarks
Light/Ordinary polyvinyl chloride sheathed cord.	$L \leq 1000(3280-5/6)$	$\geq 2 \times \text{AWG}18$	1) If the wire diameter is enlarged to $2 \times \text{AWG}16$, the total communication length can reach 1500m (4921-1/4feet). 2) The cord shall be Circular cord (the cores shall be twisted together). 3) If unit is installed in places with intense magnetic field or strong interference, it is necessary to use shielded wire.

(2) Selection for the communication cable between the indoor unit and wired controller:

Material type	Total length of communication line between IDU unit and wired controller L m(feet)	Wire size	Remarks
Light/Ordinary polyvinyl chloride sheathed cord.	$L \leq 250(820-1/5)$	$2 \times \text{AWG}18 \sim 2 \times \text{AWG}16$	1) Total length of communication line can't exceed 250m (820-1/5feet). 2) The cord shall be Circular cord (the cores shall be twisted together). 3) If unit is installed in places with intense magnetic field or strong interference, it is necessary to use shielded wire.

NOTE: All of the selected communication wire must be consistent with local laws and regulations.

2.3 Power Cable

Only copper conductors can be used as power cables. The copper conductors must meet relevant national standard and satisfy the carrying capacity of unit.

2.4 Other Requirements

Properties of the above-mentioned materials and the rest of materials that are used for the construction and installation must comply with local rules and regulations.

▲ CAUTION

- Wall thickness of copper pipe shall be consistent with above requirements and the design operating pressure shall not be lower than 3.8MPa (551psi). But if local authority has a higher requirement, please design and construct according to local safety standards.
- Materials of communication cable shall be consistent with above requirements. If there is conflict between these requirements and local relevant standards, please contact the corresponding distributor and confirm it with headquarter.
- The parallel distance between communication cable and strong current line shall be above 200mm. Communication cord must not cross with the strong current line.

PART 3 INSTALLATION SPACE REQUIREMENTS

1 PLACE SELECTION FOR INSTALLING ODU

The widely-used VRF units are applicable for various scenarios. In residential areas, especially in rooms where elderly and infants live, a higher refrigerating performance and noise control is required. Therefore, the ODU with excellent capacity and low noise is preferred; in addition, ODU should be installed in outdoor spaces instead of in bedrooms, studies or meeting rooms. In commercial areas, ODU should be installed far away from offices.

2 ODU DIMENSIONS AND INSTALLATION HOLE SIZE

External and installation dimensions of GMV-VQ72W/A-F(U) and GMV-VQ96W/A-F(U):

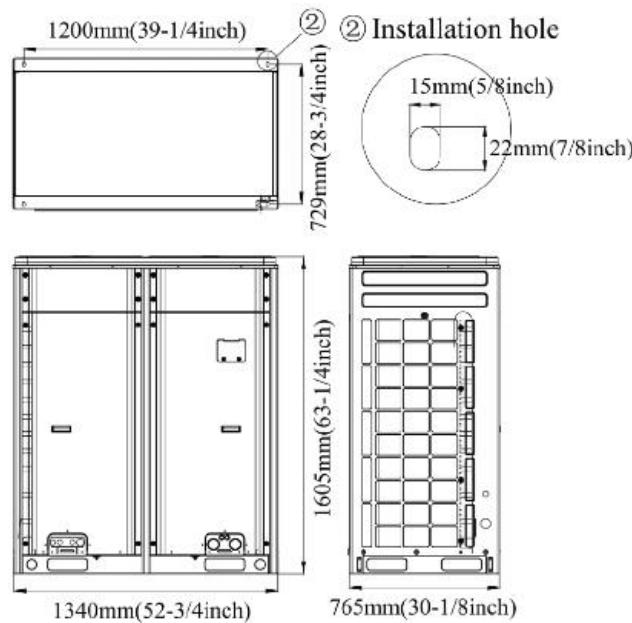

3 INSTALLATION SPACE REQUIREMENT FOR ODU

(1) If all sides of the ODU (including the top) are surrounded by walls, process according to the following requirements for installation space.

1) Space dimension for single-module unit

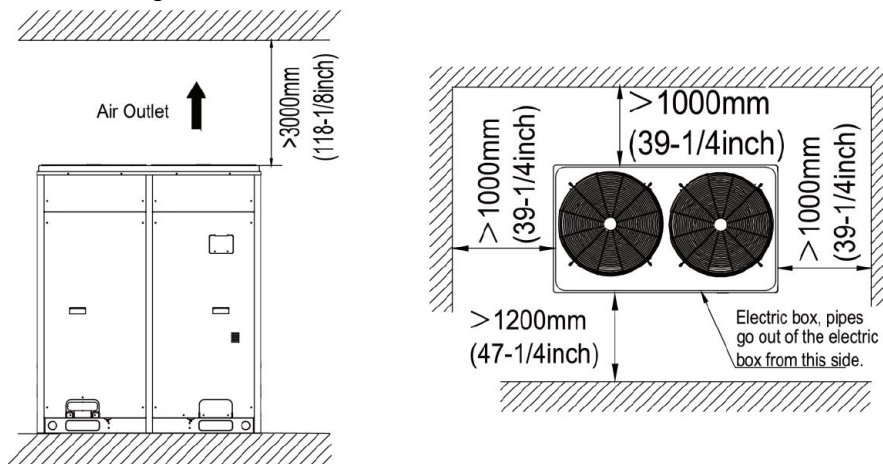

2) Space dimension for dual-module unit

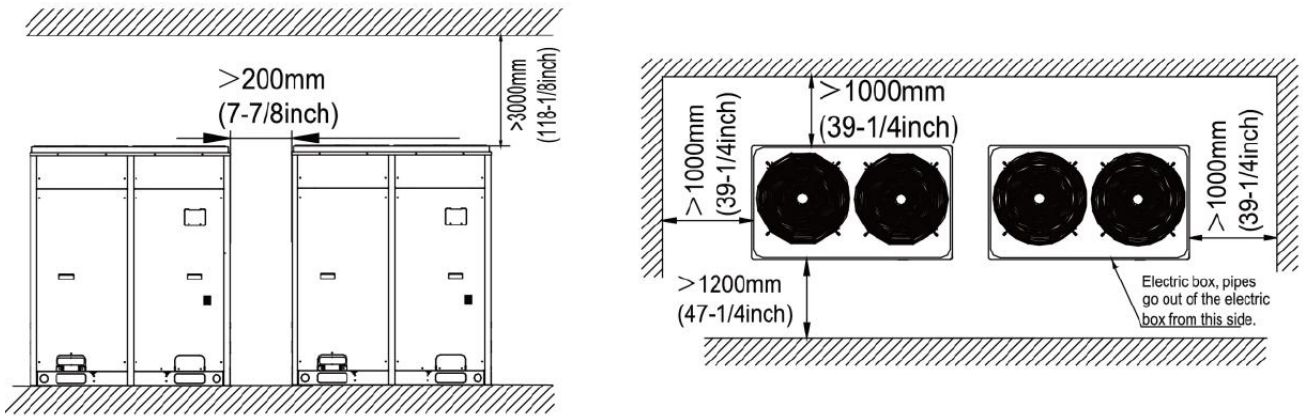

(2) Space requirement for the top of outdoor unit

When there is wall (or similar obstruction) above the unit, keep the distance between the unit top and the wall at least 3000mm (118-1/8in.) or above. When the unit is located in a totally open space with no obstructions in four directions, keep the distance between the unit top and wall at least 1500mm (59in.) or above. When space is limited within 1500mm (59in.) or the unit is not set in an open space, air outlet pipe is required to be installed in order to keep good ventilation.

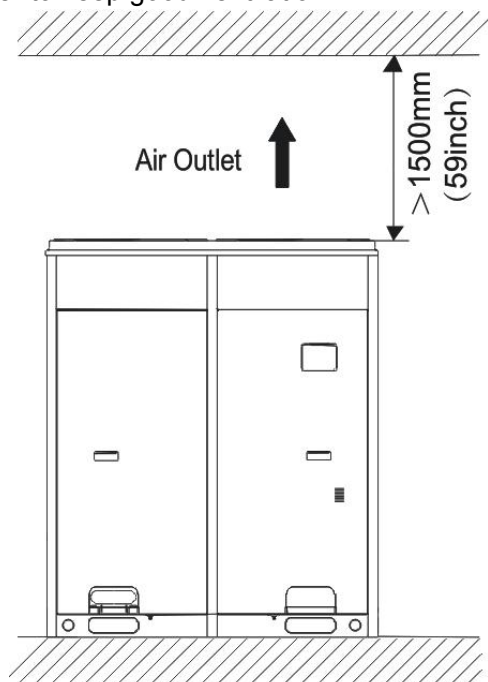

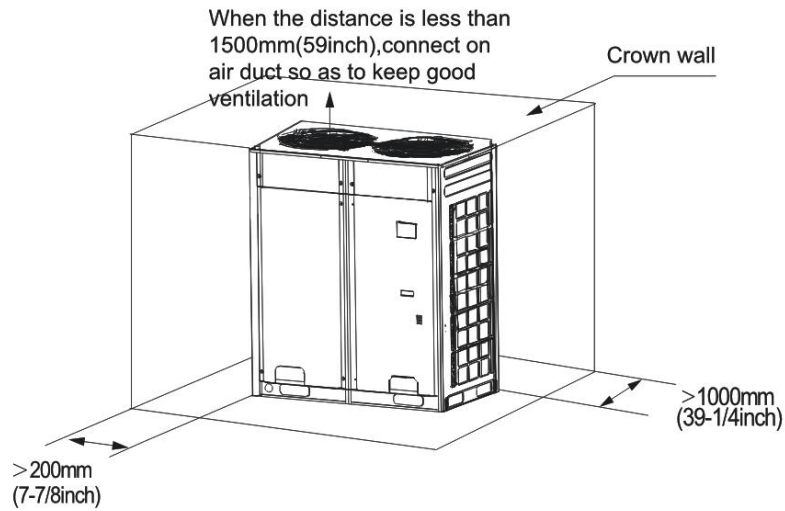

(3) Space dimension for multiple-module unit

For keeping good ventilation, make sure there are no obstructions above the unit.

When the unit is located at a half-open space (front and left/right side is open), install the unit as per the same or opposite direction.

Unit: mm(in.)

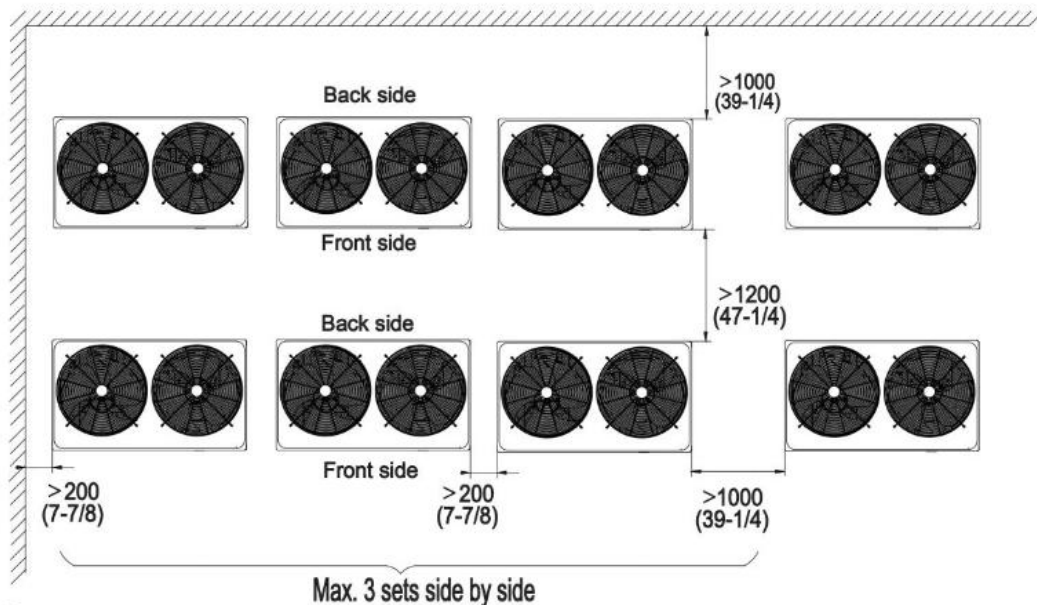
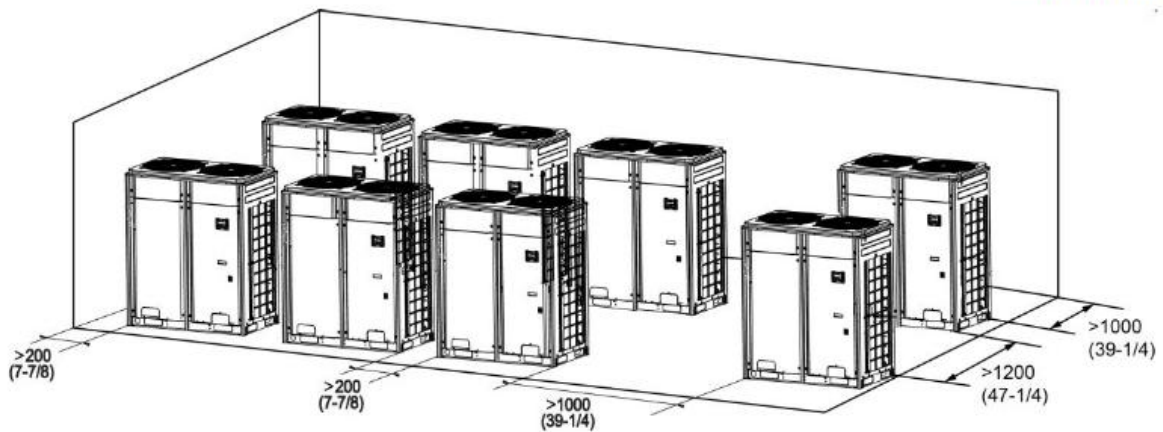

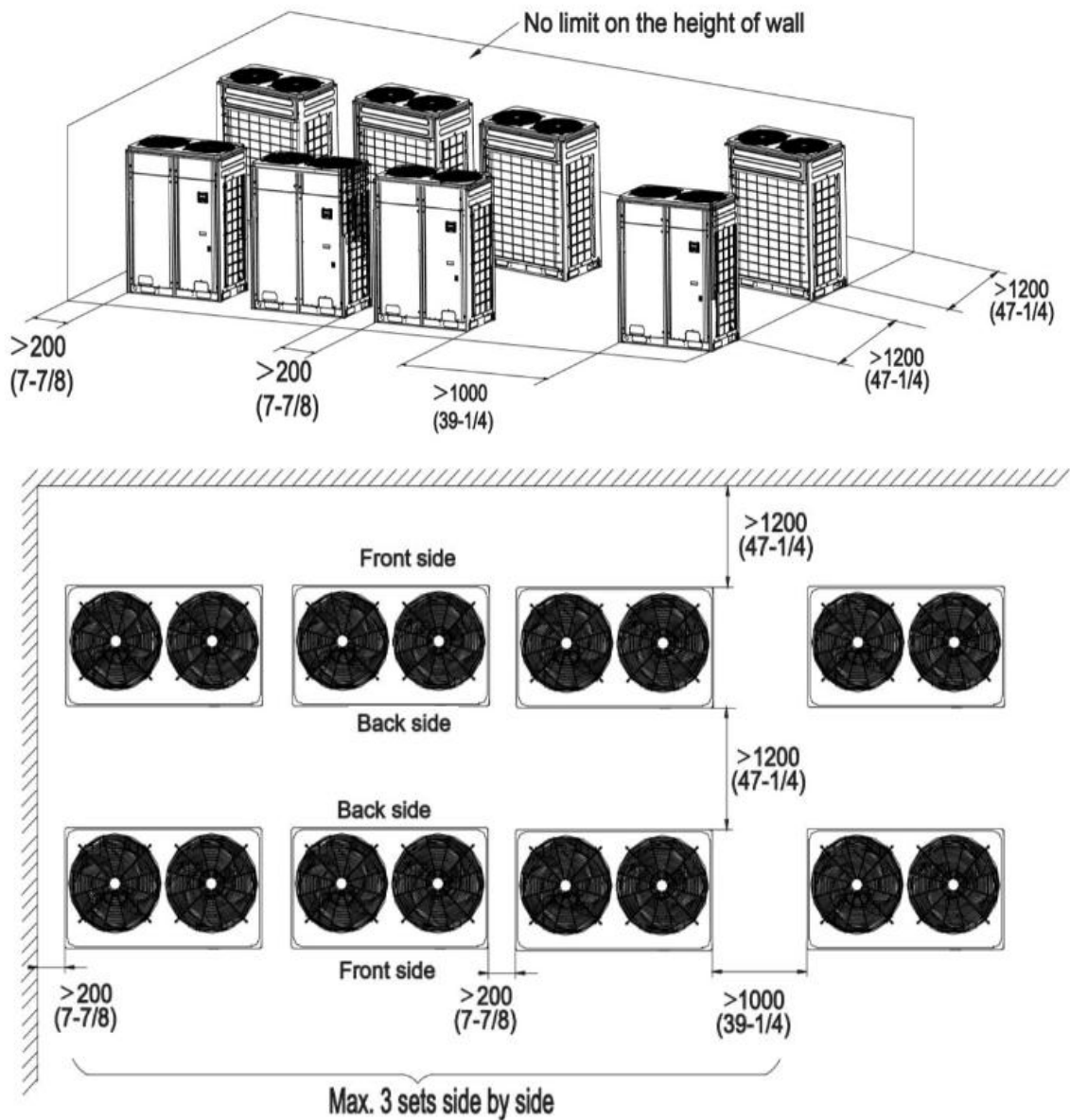

- (4) Considering the seasonal wind in outdoor unit installation

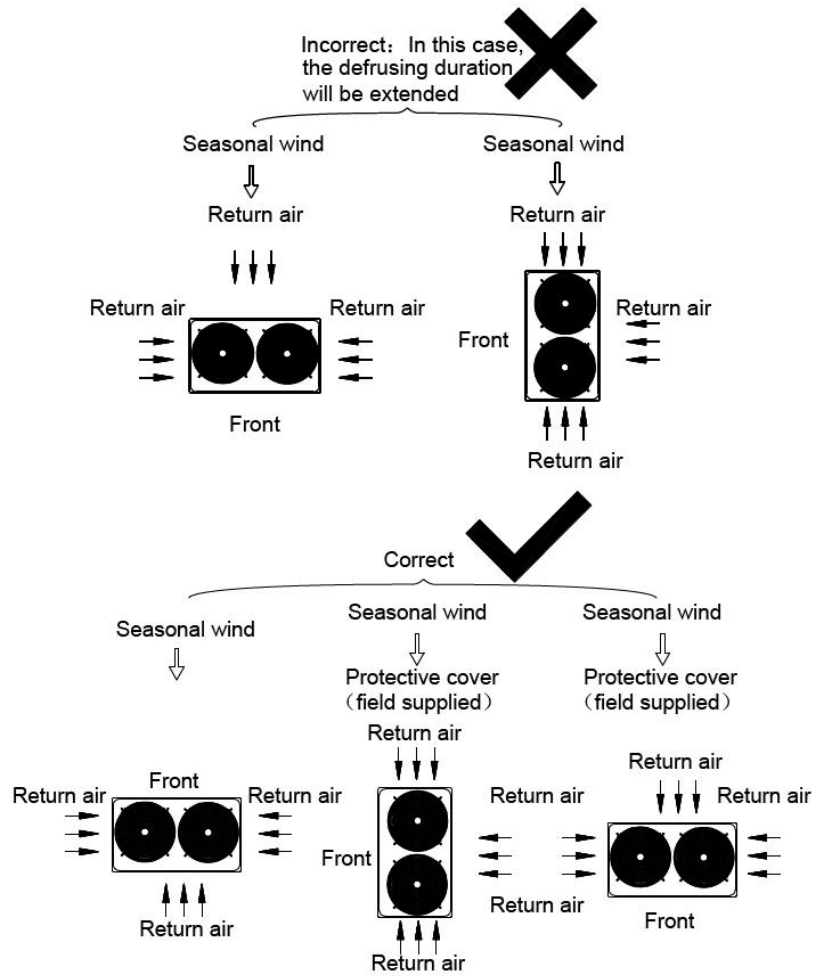

(5) Anti-monsoon installation requirements for unit connecting exhaust duct:

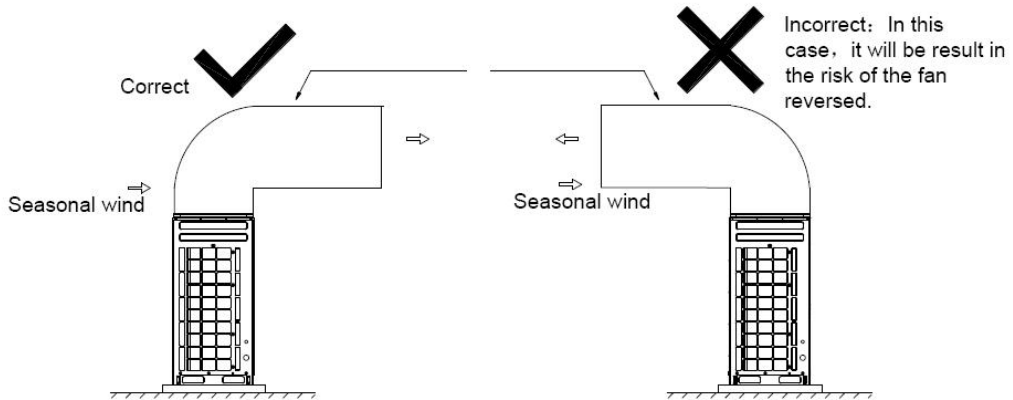

(6) Considering snow in outdoor unit installation

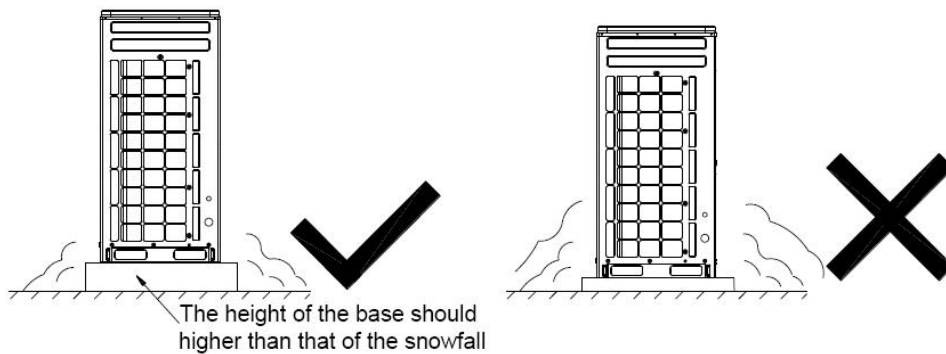

(7) During the installation of the ODU, induced and exhaust pipes must be connected. In addition, the aperture opening rate of shutters must be at least 80%, and the angle between the shutters and the horizontal plane should be less than 20°. Requirements for installing exhaust air duct are as follows:

1) Basic requirement for connecting an ODU to static pressure ventilating duct

When an ODU needs to be connected to the static pressure ventilating duct, the ventilating duct must be reasonably designed. The pressure loss caused by the ventilating duct must be calculated. In addition, a proper type of ventilating duct is necessary. To connect the static pressure ventilating duct to the ODU, three basic parts are required:

- ① ODU.
- ② Canvas.
- ③ Steel-plate ventilating duct.

The ODU must be interconnected with the ventilating duct through canvas to prevent abnormal vibration and noise generated by the steel-plate ventilating duct. The joint part must be tightly sealed with tin foil to avoid air leakage.

2) Preparations for connecting an ODU to static pressure ventilating duct

- a). The ODU is installed properly based on the unit installation requirement.
- b). The steel-plate ventilating duct is designed based on the unit and engineering requirement, and is installed properly according to the engineering standards.
- c). Based on the unit dimensions and the size of steel-plate ventilating duct, prepare materials such as canvas casing, tin foil, steel bar and tapping screw, as well as tools such as hand-operated electric drill, air screw driver and screwdriver.

3) Basic operation of connecting an ODU to static pressure ventilating duct

Two methods are available to connect an ODU to static pressure ventilating duct.

Method 1: Reserve the unit top case. Detailed operations are as follows:

- a). Install the ODU (2) and steel-plate ventilating duct (1). Use an air screw driver or screwdriver to unfasten the tapping screws that fixing the top case component (3), and then remove the top case component. Take out the grille from the top of the top case component and leave the top case.
- b). Put the canvas casing inside out (4). Cover one end of the canvas casing over the unit downward until the canvas end face is aligned with the unit or a bit higher than the top of the unit. Then, put the top case back (3) and tightly press the canvas casing (4). Use tapping screws to fix the top case onto the unit (3).
- c). Pull up the canvas casing reversely (4) and use the steel bar (5) to press the canvas casing tightly onto the counter flange of the steel-plate ventilating duct (1). Use a hand-operated electric drill to drill holes and fasten the parts by using tapping screws.
- d). Use the tin foil to seal the joints and check the joints' reliability.

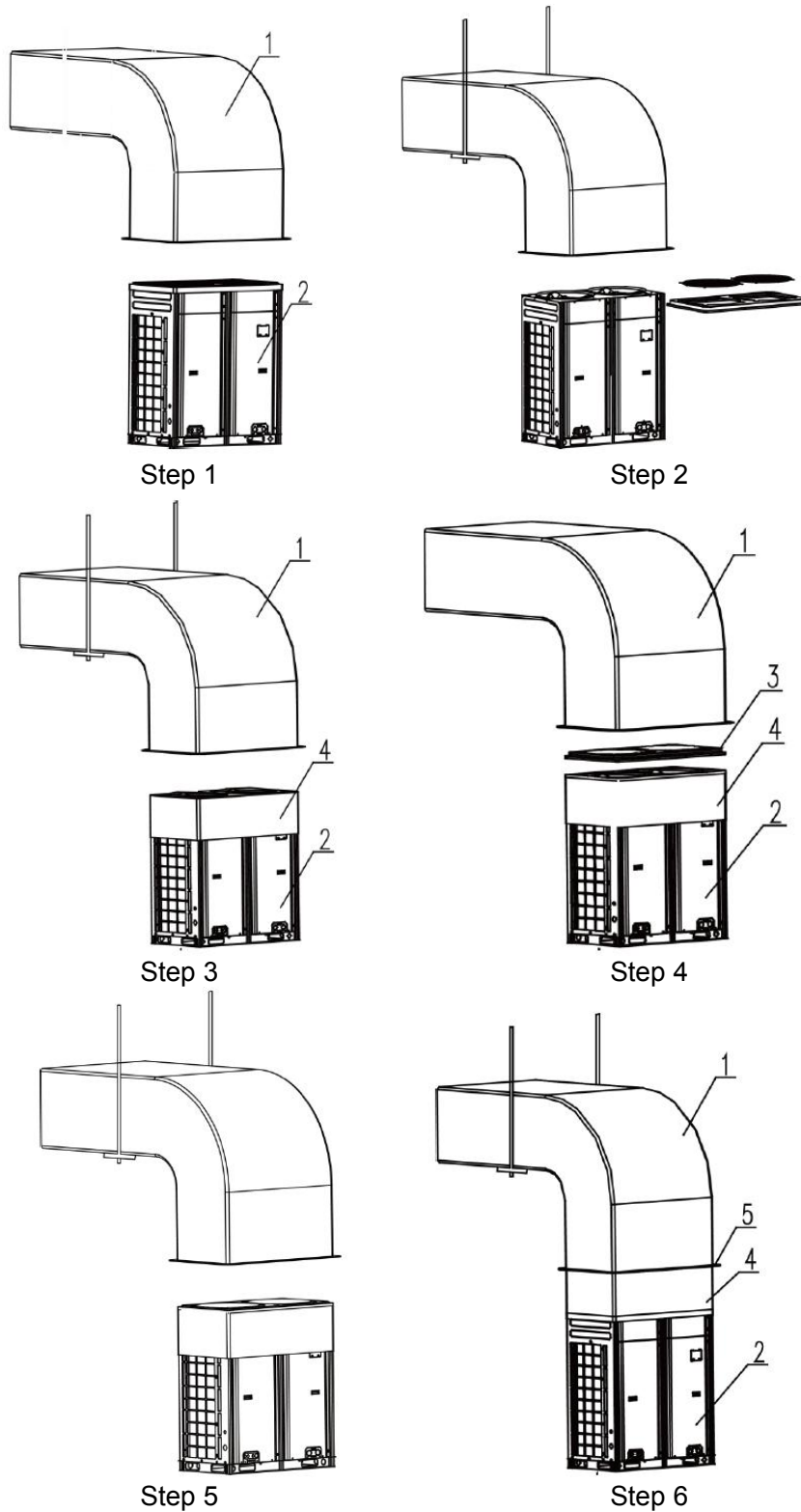

Method 2: Remove the unit top case. Detailed operations are as follows:

- a). Install the ODU (2) and steel-plate ventilating duct (1). Take out the grille from the top of the top case component. Use the prepared canvas casing inside out (4) to cover the surroundings over the top of the unit. Keep the top of canvas casing (4) 30 to 50 mm higher over the top of the unit.
- b). Use a steel bar to press tightly the canvas casing (4) around the top case of the unit. Use a hand-operated electric drill to drill holes and fasten the canvas casing onto the unit through steel bar by

using tapping screws.

c). Pull up the canvas casing reversely and use the steel bar to press the canvas casing tightly onto the counter flange of the steel-plate ventilating duct. Use a hand-operated electric drill to drill holes and fasten the parts by using tapping screws.

d). Use the tin foil to seal the joints and check the joints' reliability.

NOTE: Remove the grille on the top case when connecting an ODU to static pressure ventilating duct; otherwise, the air volume, especially the unit operating performance will be affected. For method 2, since drills are required on the top case, the powder coated protective layer on the top case will be damaged. As a result, the anti-corrosion performance of the unit top case will be reduced.

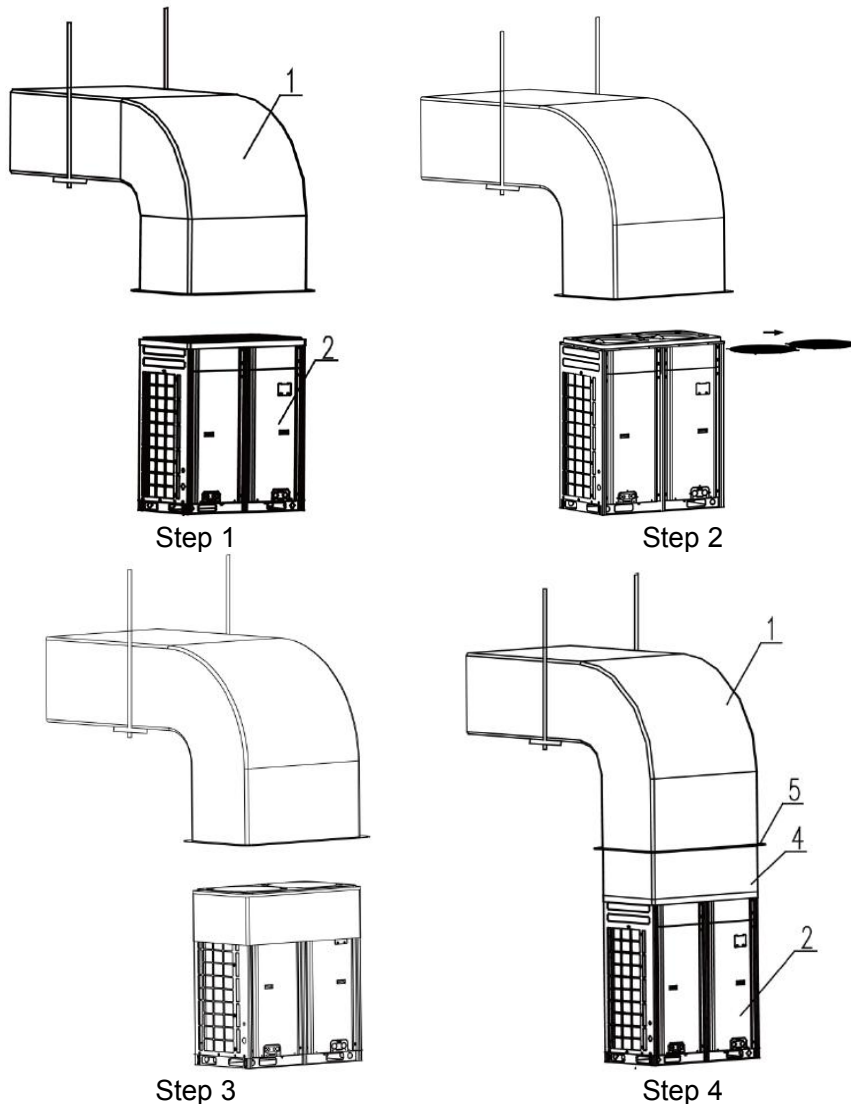

(1) When the effective area of air intake is less than 70% of the total air intake area of all ODUs, an induced draft fan is also required. The total air input of induced draft fan should be no less than 80% of the total supply air rate.

(2) Lifting method

When carrying the suspended, unit pass the ropes under the unit and use the two suspension points each at the front and rear.

Always lift the unit with ropes attached at four points so that impact is not applied to the unit.

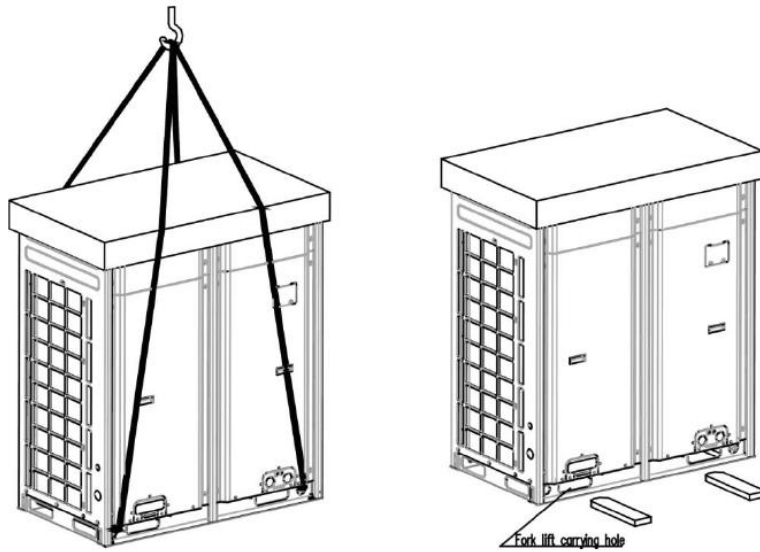

▲ CAUTION

Be very careful while carrying the product.

- ① Do not have only one person carry product if it is more than 20kg (44lbs).
- ② PP bands are used to pack some products. Do not use them as a mean for transportation because they are dangerous.
- ③ Do not touch heat exchanger fins with your bare hands. Otherwise you may get a cut in your hands.
- ④ Tear plastic packaging bag and scrap it so that children cannot play with it. Otherwise plastic packaging bag may suffocate children to death.
- ⑤ When carrying in Outdoor Unit, be sure to support it at four points. Carrying in and lifting with 3-point support may make Outdoor Unit unstable, resulting in a fall.
- ⑥ Use 2 belts of at least 3m(26.2ft) long.
- ⑦ Place extra cloth or boards in the locations where the casing comes in contact with the sling to prevent damage.
- ⑧ Hoist the unit making sure it is being lifted at its center of gravity.

PART 4 REQUIREMENTS ON FOUNDATION INSTALLATION

1 ODU FOUNDATION

The concrete foundation of the ODU must be strong enough. Ensure that the drainage is smooth and that the ground drainage or floor drainage is not affected.

Requirements on the concrete foundation are as follows:

- ◆ The concrete foundation must be flat and have enough rigidity and strength to undertake the unit's weight during running. The height of the foundation is 200 mm (7.87inch) to 300 mm(11.8inch), which is determined based on the size of the unit.
- ◆ The proportion of the cement, sand, and stone for the concrete is 1:2:4. Place 10 reinforced steel bars ($\phi 10$ mm) with a space between of 30 mm.
- ◆ Use the mortar to flatten the surface of the foundation. Sharp edges must be chamfered.
- ◆ When the foundation is built on a concrete floor, crushed stones are not required. But the foundation surface must be roughened.
- ◆ Clear the oil stains, crushed stones, dirt, and water in the reserved bolt hole of the foundation and install a temporary cover before installing bolts.
- ◆ Build a drainage ditch around the foundation to discharge the condensate water.
- ◆ If the air conditioner is installed on the roof, check the intensity of the building and take waterproof measures.
- ◆ If a u-steel foundation is adopted, the structure must be designed with sufficient rigidity and strength.

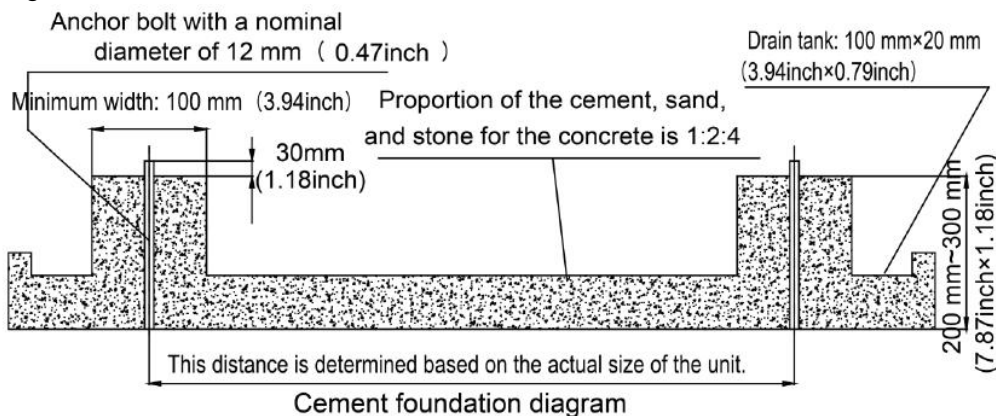

▲WARNING

① Install where it can sufficiently support the weight of the outdoor unit. If the support strength is not enough, the outdoor unit may drop and hurt people.

② Install where the outdoor unit may not fall in strong wind or earthquake. If there is a fault in the supporting conditions, the outdoor unit may fall and hurt people.

③ Please take extra cautions on the supporting strength of the ground, liquid outlet treatment (treatment of the liquid flowing out of the outdoor unit in operation), and the passages of the pipe and wiring, when making the ground support.

④ Do not use tube or pipe for liquid outlet in the Base pan. Use drainage instead for liquid outlet. The tube or pipe may freeze and the liquid may not be drained.

⑤ Be sure to remove the MDF (wood support) of the bottom side of the outdoor unit Base Pan before fixing the bolt. It may cause the unstable state of the outdoor settlement, and may cause freezing of the heat exchanger resulting in abnormal operations.

⑥ Be sure to remove the MDF (wood support) of the bottom side of the outdoor unit before welding. Not removing MDF causes hazard of fire during welding.

2 ODU FIXING

Fix the ODU to the foundation with four M12 bolts securely to reduce vibration and noise.

3 VIBRATION REDUCTIONS FOR ODU

The ODU must be fixed securely. Apply a thick rubber sheet or corrugated damping rubber pad with thickness of 200 mm (7.87inch) or more and width of 100 mm(3.94inch) or more between the ODU and the foundation, as shown in the following figures.

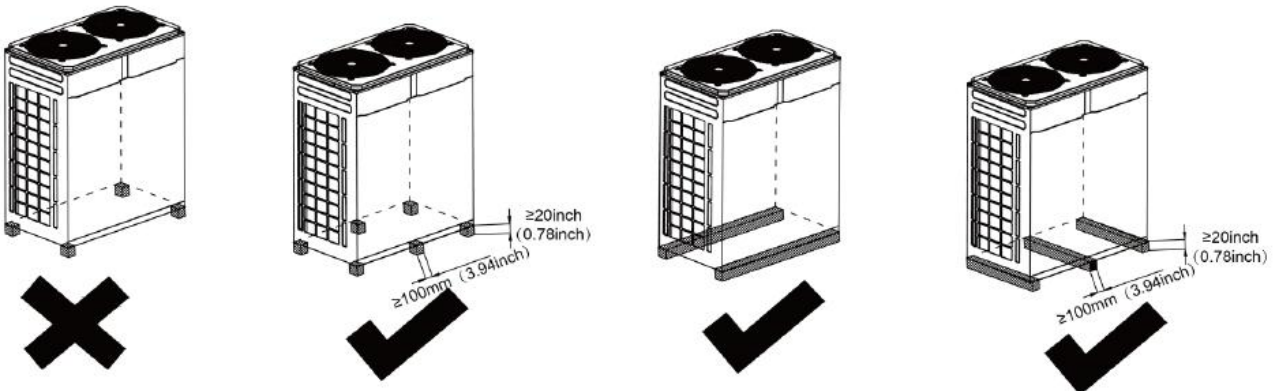

PART 5 PIPING CONNECTION

1 SCHEMATIC DIAGRAM OF PIPING CONNECTION

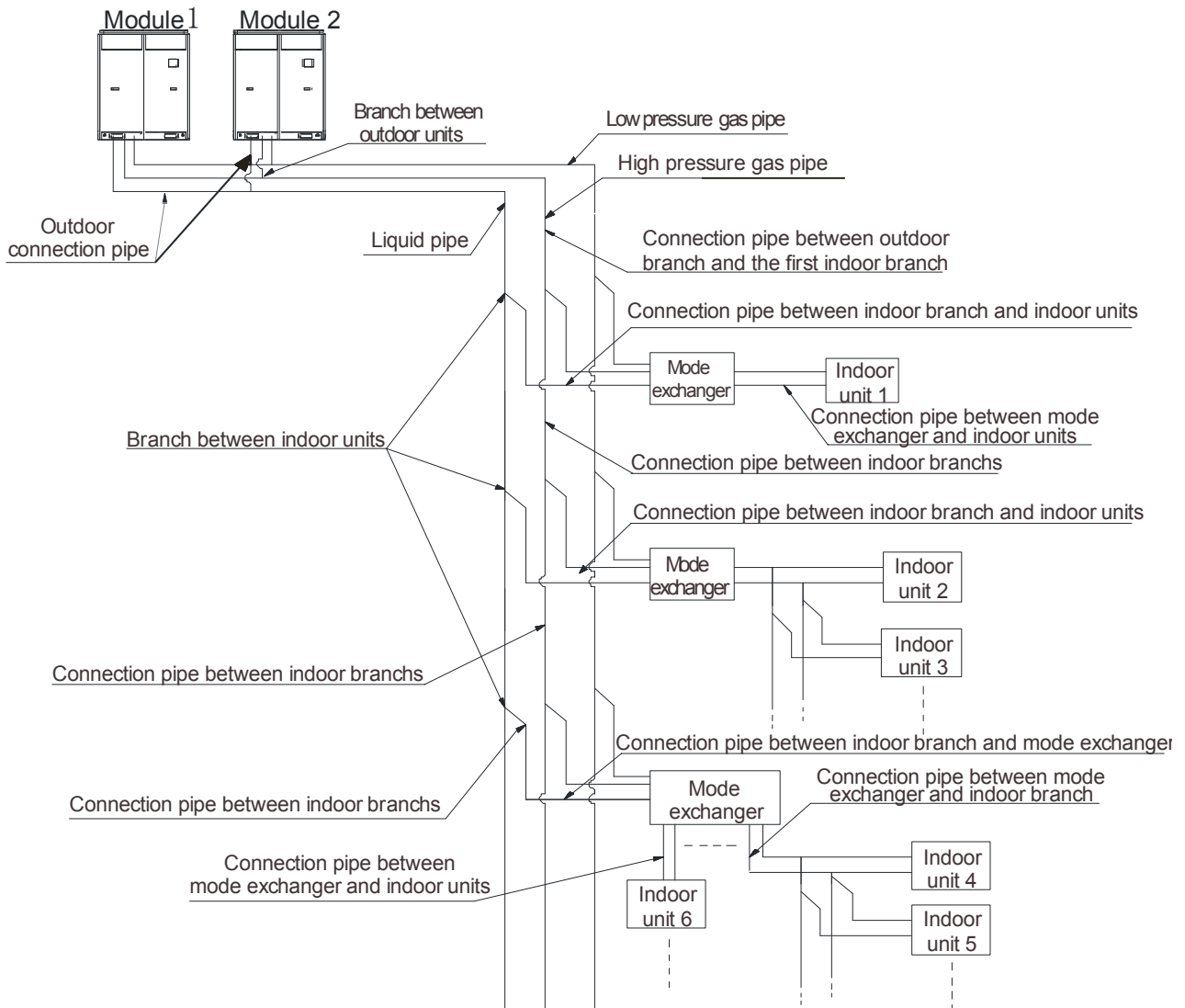

2 SCHEMATIC DIAGRAM OF PIPING SEQUENCE

GMV-VQ72W/A-F(U), GMV-VQ96W/A-F(U):

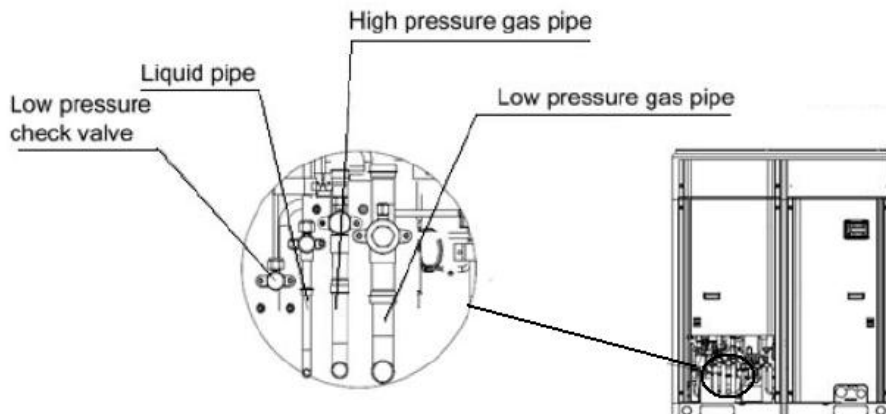

3 ALLOWABLE PIPE LENGTH AND DROP HEIGHT AMONG IDU AND ODU

Y type branch joint is adopted to connected indoor and outdoor units. Connecting method is shown in the figure below.

Remark: Equivalent length of one Y-type manifold is about 0.5m(1-3/4feet).

Module 1 Module 2

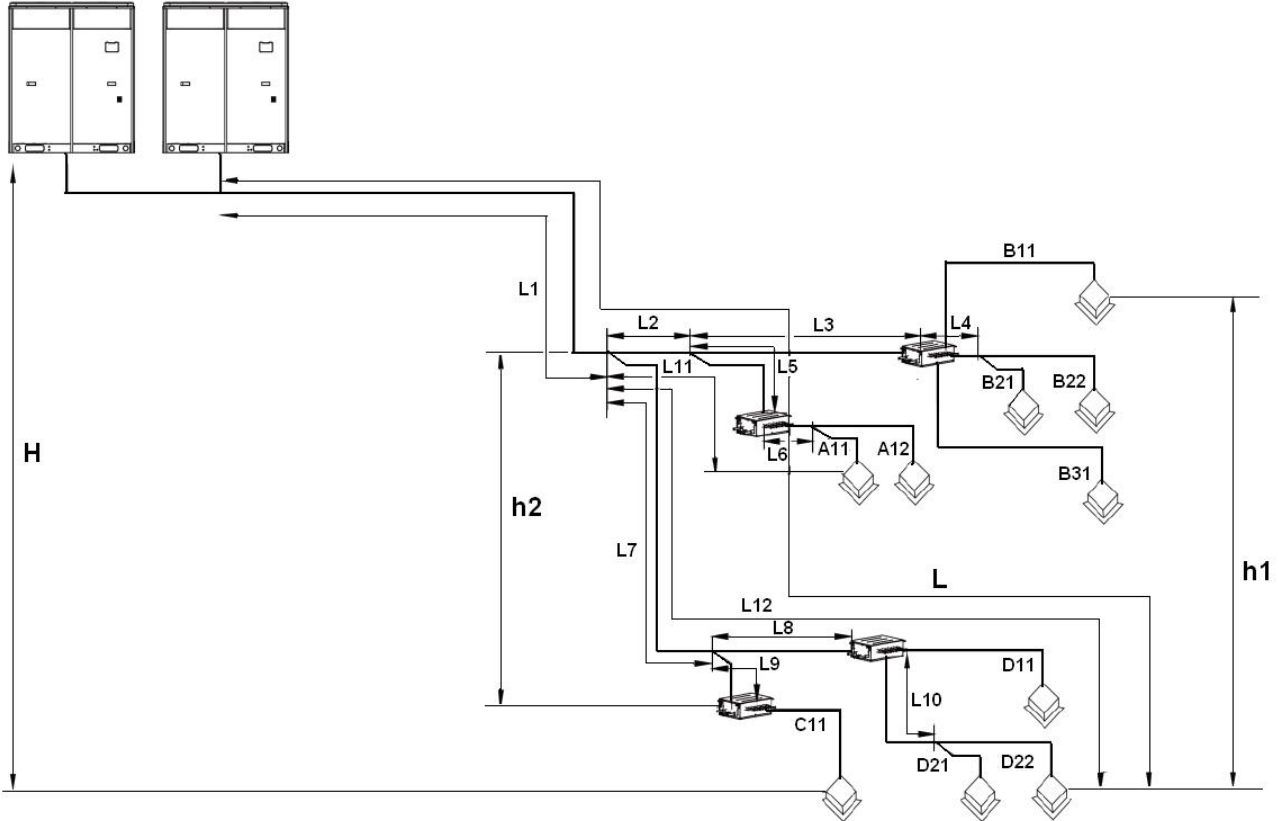

L12: Length from the first branch to the farthest IDU; L11: Length from the first branch to the nearest IDU; Equivalent length of branch of IDU is 0.5m (1-3/4feet).

Equivalent length of mode exchanger depends on the using situation, for example, when using one branch, the length is 1m (39-3/8 inch), when using N branches, the length is N meters.

R410A Refrigerant System		Allowable Value m(feet)	Fitting Pipe
Total length (actual length) of fitting pipe		$\leq 1000(3280-3/4)$	$L1+L2+L3+L4+...+L10+A11+A12+...+D21+D22$
Length of farthest fitting pipe m(feet)	Actual length	$\leq 165(541-1/4)$	$L1+L7+L8+L10+D22$
	Equivalent length	$\leq 190(623-1/4)$	
Difference between the pipe length from the first branch of IDU to the farthest IDU and the pipe length from the first branch of IDU to the nearest IDU		$\leq 40(131-1/4)$	$L12-L11$
Equivalent length from the first branch to the furthest piping (1)		$\leq 40(131-1/4)$	$L7+L8+L10+D22$
Height difference between outdoor unit and indoor unit	Outdoor unit at upper(2)	$\leq 50(164)$	—
	Outdoor unit at lower(2)	$\leq 40(131-1/4)$	—

Height difference between indoor units	≤15(49)	—
Maximum length of Main pipe(3)	≤90(295-1/4)	L1
From IDU to its nearest branch (4)	≤40(131-1/4)	A11,A12,B11,B21,B22,B31,C11,D11, D21,D22

NOTICE!

(1) Normally, the pipe length from the first branch of IDU to the farthest IDU is 40m (131-1/4feet). Under the following conditions, the length can reach 90m (295-1/4feet).

1) Actual length of pipe in total: $L1+L2x2+L3x2+L4x2+...+L9x2+a+b+...+i+j \leq 1000m$ (3280-3/4feet).

2) Length between each IDU and its nearest branch a, b, c, d, e, f, g, h, i, $j \leq 40m$ (131-1/4feet).

3) Difference between the pipe length from the first branch of IDU to the farthest IDU and the pipe length from the first branch of IDU to the nearest IDU: $L12-L11 \leq 40m$ (131-1/4feet).

(2) When the outdoor unit is at upper side and height difference is more than 50m, please consult company for the related technical requirement.

(3) When the maximum length of the main pipe from ODU to the first branch of IDU is $\geq 50m$ (164 ft), then adjust the pipe size.

Total rated capacity of ODU: C (Btu/h)	Pipe between outdoor unit and the first indoor branch		
	Low pressure gas pipe mm(inch)	Liquid pipe mm(inch)	High pressure gas pipe mm(inch)
GMV-VQ72W/A-F(U)	No need to enlarge pipe size	No need to enlarge pipe size	Φ22.2(7/8)
GMV-VQ96W/A-F(U)	No need to enlarge pipe size	No need to enlarge pipe size	Φ22.2(7/8)
GMV-VQ144WM/A-F(U)	No need to enlarge pipe size	Φ19.05(3/4)	Φ31.8(1-1/4)
GMV-VQ168WM/A-F(U)	No need to enlarge pipe size	Φ19.05(3/4)	Φ31.8(1-1/4)
GMV-VQ192WM/A-F(U)	No need to enlarge pipe size	Φ19.05(3/4)	Φ31.8(1-1/4)

(4) If the length between an IDU and its nearest branch is above 10m (32-3/4feet), then increase the size of the liquid pipe of IDU (only for the pipe size that is $\leq 6.35mm$ (1/4inch)).

4 CONNECTION PIPE AMONG ODU MODULES

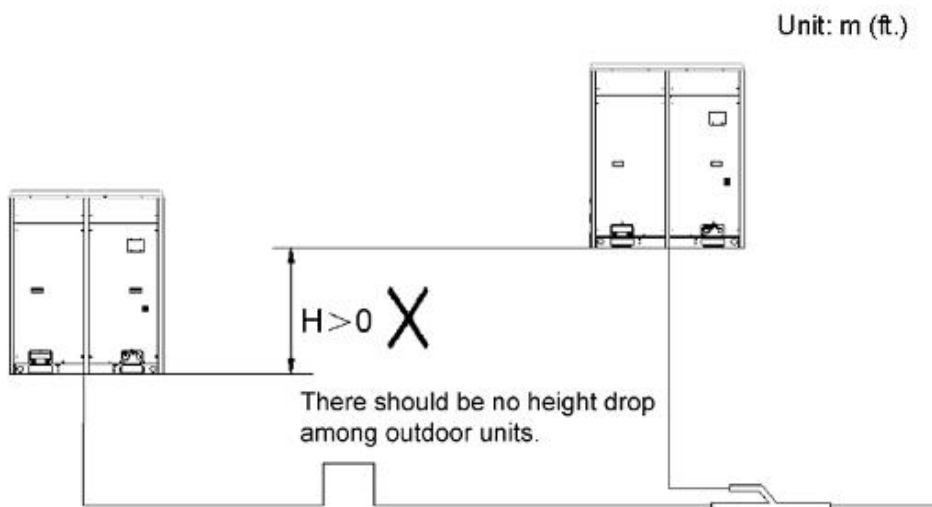

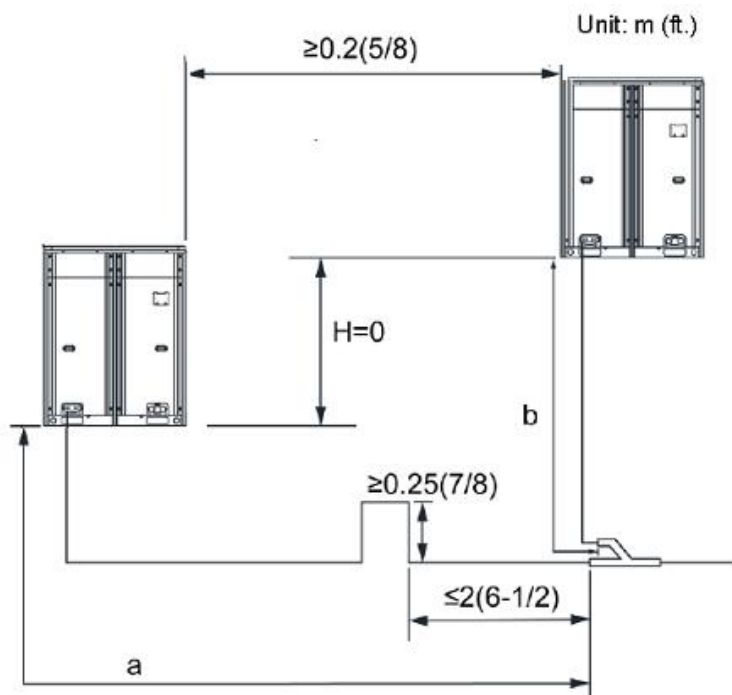

Note: when the distance between outdoor units exceeds 2m (6-1/2 feet), U-type oil trap should be added at low-pressure gas pipe. $a \leq 10m$ (32-7/8 feet); $b \leq 10m$ (32-7/8 feet).

5 SIZE REQUIREMENT FOR FITTING PIPE AND BRANCH

(1) Connection sketch map of single-module system

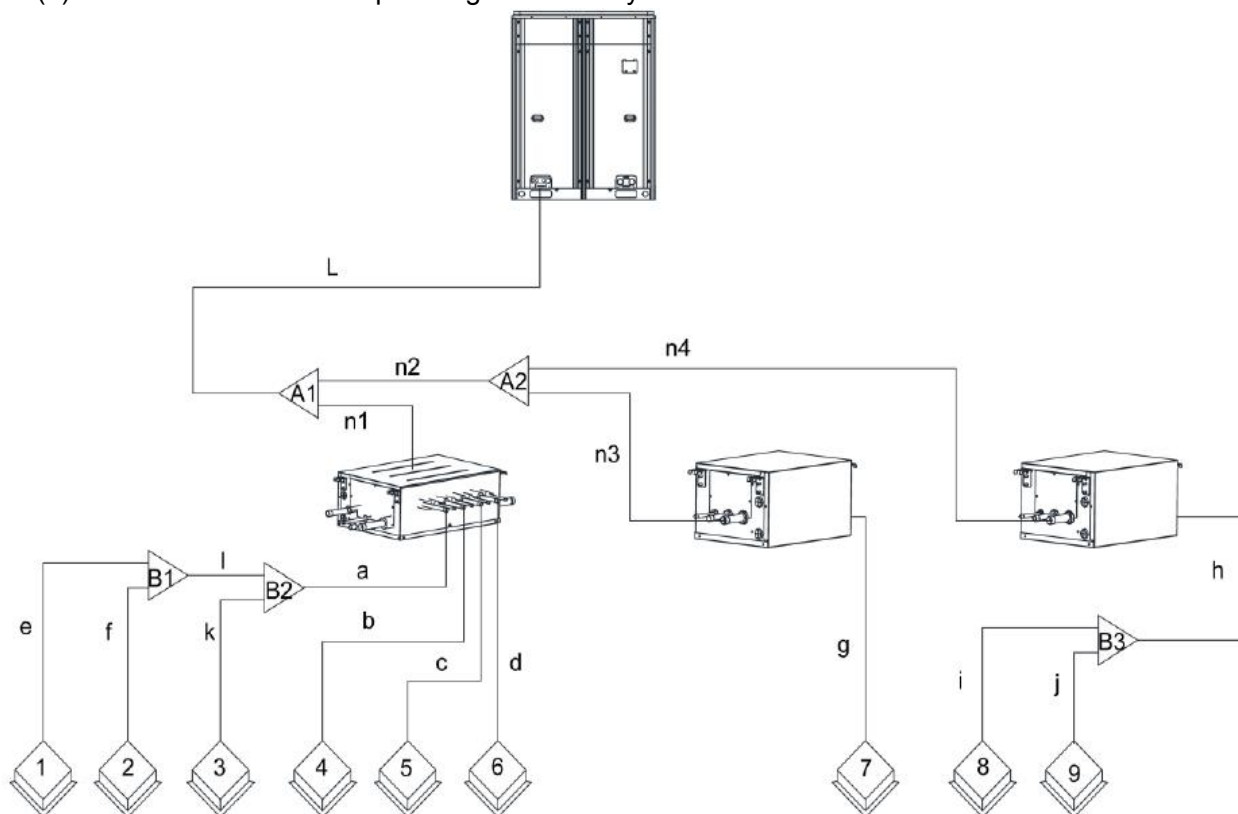

(2) Connection sketch map of multi-module system

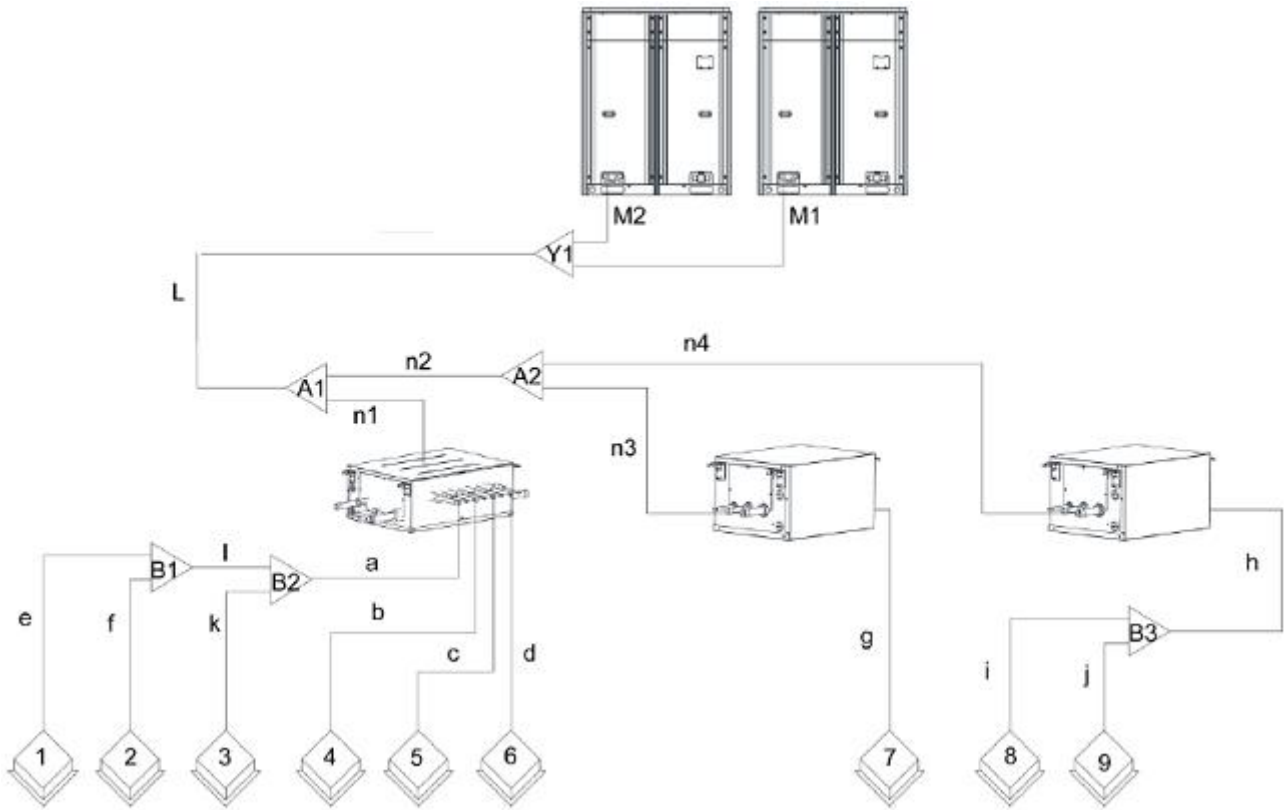

5.1 Pipe selection between outdoor unit and the first indoor branch (L)

Select appropriate pipe between outdoor unit and the first indoor branch (L) as per the pipe size of outdoor unit. For single module, L pipe between the basic outdoor unit and the first indoor branch:

Basic module	Pipe between outdoor unit and the first indoor branch		
	Low pressure gas pipe mm(inch)	Liquid pipe mm(inch)	High pressure gas pipe mm(inch)
GMV-VQ72W/A-F(U)	Φ28.6(1-1/8)	Φ12.7(1/2)	Φ19.05(3/4)
GMV-VQ96W/A-F(U)	Φ28.6(1-1/8)	Φ12.7(1/2)	Φ19.05(3/4)

For multi-module, L pipe between the terminal outdoor branch and the first indoor branch:

Basic module	Pipe between outdoor unit and the first indoor branch		
	Low pressure gas pipe mm(inch)	Liquid pipe mm(inch)	High pressure gas pipe mm(inch)
GMV-VQ144WM/A-F(U)	Φ34.9(1-3/8)	Φ15.9(5/8)	Φ28.6(1-1/8)
GMV-VQ168WM/A-F(U)	Φ34.9(1-3/8)	Φ15.9(5/8)	Φ28.6(1-1/8)
GMV-VQ192WM/A-F(U)	Φ34.9(1-3/8)	Φ15.9(5/8)	Φ28.6(1-1/8)

5.2 ODU pipe size selection for multi-module system

Pipe size between module and outdoor branch “M1, M2”:

Basic module	Pipe between outdoor unit and the first indoor branch		
	Low pressure gas pipe mm(inch)	Liquid pipe mm(inch)	High pressure gas pipe mm(inch)

GMV-VQ72W/A-F(U)	Φ28.6(1-1/8)	Φ12.7(1/2)	Φ19.05(3/4)
GMV-VQ96W/A-F(U)	Φ28.6(1-1/8)	Φ12.7(1/2)	Φ19.05(3/4)

Selection of branch “Y1” connecting to outdoor modules:

Module's capacity C (Btu/h)	Model
$C \leq 327500$	ML01R
$327500 < C$	ML02R

5.3 Branch selection of mode exchanger (A1, A2)

Model selection for branch “A1、A2” of mode exchanger

R410A refrigerant system	Total Capacity of the Downstream Indoor Unit X(Btu/h)	Model
Y-Type Branch Pipe	$X \leq 17100$	FQ01Na/A
	$17100 < X \leq 72000$	FQ02Na/A
	$72000 < X \leq 96000$	FQ03Na/A
	$96000 < X \leq 232000$	FQ05Na/A
	$232000 < X \leq 327500$	FQ05Na/A
	$327500 < X$	FQ06Na/A

5.4 Piping size among upstream branches of mode exchanger (n1, n2, n3, n4)

Piping requirement among upstream branches of mode exchanger (n1, n2, n3, n4)

Total rated capacity of downstream indoor units: X(Btu/h)	Size of connection pipe between branches of mode exchanger		
	Low pressure gas pipe mm(inch)	Liquid pipe mm(inch)	High pressure gas pipe mm(inch)
$X \leq 17100$	Φ12.7(1/2)	Φ6.35(1/4)	Φ12.7(1/2)
$17100 < X \leq 48500$	Φ15.9(5/8)	Φ9.52(3/8)	Φ12.7(1/2)
$48500 < X \leq 72000$	Φ19.05(3/4)	Φ9.52(3/8)	Φ15.9(5/8)
$72000 < X \leq 96000$	Φ22.2(7/8)	Φ9.52(3/8)	Φ19.05(3/4)
$96000 < X \leq 120000$	Φ28.6(1-1/8)	Φ12.7(1/2)	Φ22.2(7/8)
$120000 < X \leq 144000$	Φ28.6(1-1/8)	Φ12.7(1/2)	Φ22.2(7/8)
$144000 < X \leq 168000$	Φ28.6(1-1/8)	Φ15.9(5/8)	Φ28.6(1-1/8)
$168000 < X \leq 216000$	Φ28.6(1-1/8)	Φ15.9(5/8)	Φ28.6(1-1/8)
$216000 < X \leq 240000$	Φ34.9(1-3/8)	Φ15.9(5/8)	Φ28.6(1-1/8)
$240000 < X \leq 312000$	Φ34.9(1-3/8)	Φ19.05(3/4)	Φ28.6(1-1/8)
$312000 < X \leq 336000$	Φ34.9(1-3/8)	Φ19.05(3/4)	Φ28.6(1-1/8)
$336000 < X \leq 360000$	Φ41.3(1-5/8)	Φ19.05(3/4)	Φ34.9(1-3/8)

5.5 Piping size among downstream branches of mode exchanger (a, h)

Rated capacity of indoor unit C(Btu/h)	Pipe between branches and mode exchanger	
	Gas Pipe mm(inch)	Liquid Pipe mm(inch)
$C \leq 9500$	Φ9.52(3/8)	Φ6.35(1/4)

9500<C≤17100	Φ12.7(1/2)	Φ6.35(1/4)
17100<C≤48500	Φ15.9(5/8)	Φ9.52(3/8)

5.6 Branch selection of downstream indoor unit of mode exchanger (B1, B2)

R410A refrigerant system	Total rated capacity of downstream indoor units: X(Btu/h)	Model
Y-type branch	X≤48500	FQ01A/A

5.7 Piping size between mode exchanger and downstream indoor unit (b, c, d, g)

Rated capacity of indoor unit C(Btu/h)	Pipe between mode exchanger and IDU	
	Gas Pipe mm(inch)	Liquid Pipe mm(inch)
C≤9500	Φ9.52(3/8)	Φ6.35(1/4)
9500<C≤17100	Φ12.7(1/2)	Φ6.35(1/4)
17100<C≤48500	Φ15.9(5/8)	Φ9.52(3/8)

5.8 Piping between indoor branch and indoor unit (e, f, i, j, k)

Size of connection pipe between indoor branch and indoor unit should be consistent with the connection pipe of indoor unit.

Rated capacity of indoor units: X ((Btu/h)	Size of connection pipe between indoor branch and indoor unit	
	Gas pip mm(inch)	Liquid pipe mm(inch)
C≤9500	Φ9.52(3/8)	Φ6.35(1/4)
9500<C≤17100	Φ12.7(1/2)	Φ6.35(1/4)
17100<C≤48500	Φ15.9(5/8)	Φ9.52(3/8)

5.9 Pipe size between indoor branches (“I”)

Rated capacity of indoor units: X ((Btu/h)	Size of connection pipe between indoor branch and indoor unit	
	Gas pipe mm(inch)	Liquid pipe mm(inch)
X≤9500	Φ9.52(3/8)	Φ6.35(1/4)
9500<X≤17100	Φ12.7(1/2)	Φ6.35(1/4)
17100<X≤48500	Φ15.9(5/8)	Φ9.52(3/8)

5.10 Connection method when capacity of indoor unit exceeds 48500 Btu/h

When connecting to the indoor unit with capacity of over 48500 Btu/h, it is not allowed to connect with only one branch; it must use two branches controlled by the same main board for parallel connection.

Parallel connection	Indoor unit communication connection for mode exchanger	Remarks
Indoor unit No.1 and No.2	“1D1 1D2”	Parallel connection can be conducted only as the combination of this table, it is not allowed to otherwise connect. Note that after the connection, manually set the SA2 dial code of corresponding mainboard, and dial the code in the first place to number end.
Indoor unit No.3 and No.4	“3D1 3D2”	
Indoor unit No.5 and No.6	“5D1 5D2”	
Indoor unit No.7 and No.8	“7D1 7D2”	

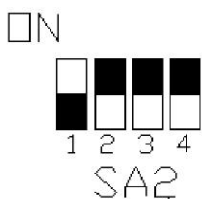

Connecting method is shown as in the Fig.23.

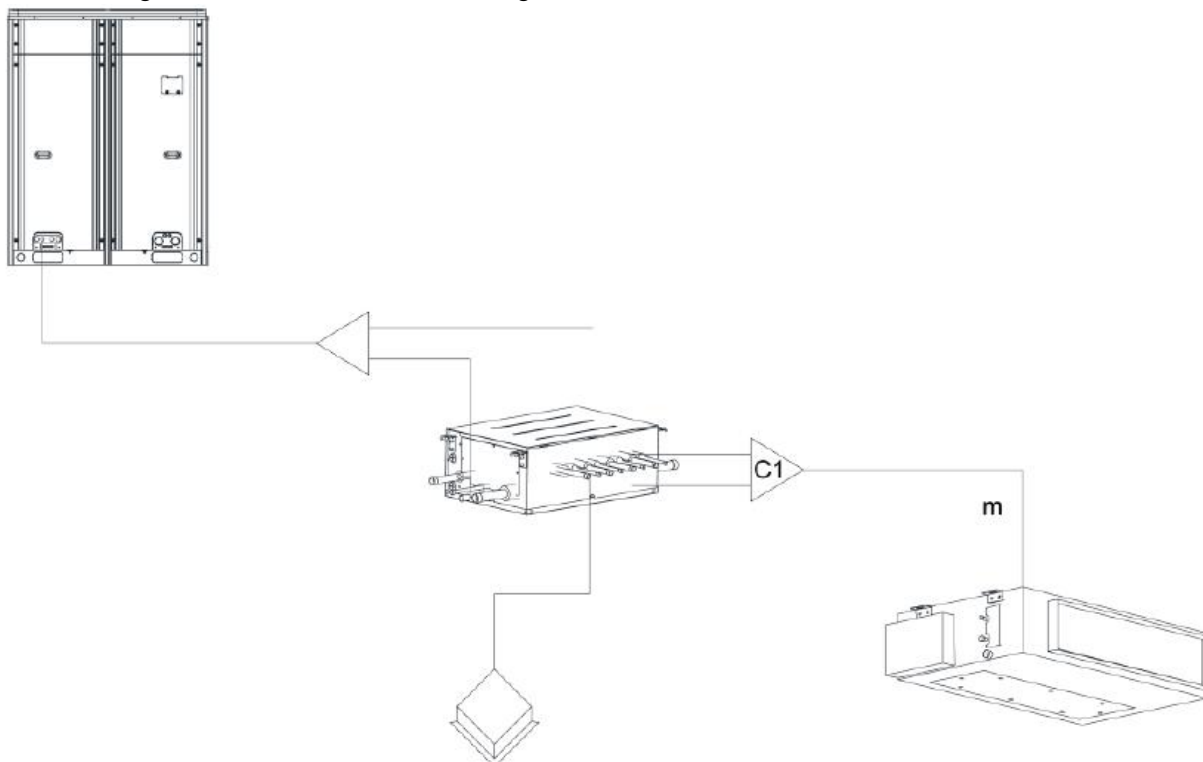

1) Branch selection of indoor unit of mode exchanger (“C1”)

R410A refrigerant system	Total rated capacity of downstream indoor units: X(Btu/h)	Model
Y-type branch	48500<X≤96000	FQ01B/A

2) Pipe size between mode exchanger and downstream and indoor unit (“m”)

Rated capacity of indoor units: X ((Btu/h)	Size of connection pipe between indoor branch and indoor unit	
	Gas pipe mm(inch)	Liquid pipe mm(inch)
48500<X≤72000	Φ19.05(3/4)	Φ9.52(3/8)
72000<X≤96000	Φ22.2(7/8)	Φ9.52(3/8)

PART 6 PIPE INSTALLATION AND INSULATION

1 PIPE INSTALLATION FOR THE COOLING SYSTEM

1.1 Precautions on Pipe Direction Design

Refrigerant pipe layout must be designed in accordance with the following principles:

- (1) The air conditioning installation should not damage the bearing structure or the decorative style.

Air conditioning pipes should be laid out along the bottom of beam as possible. If pipes meet one another at the same elevation, process based on the following principles:

Drain pipes enjoy the highest priority. Air ducts and pressure pipes should leave places for gravity pipes.

Air ducts and small pipes should leave places for major pipes.

- (2) The refrigerant pipe layout must be optimal in actual engineering with minimum pipe length and bends. In this way, the performance of the unit can be maximized.

(3) The refrigerant pipe cannot affect air discharge and return of internal units. The minimum distance between the refrigerant pipe with an insulation layer and the air return box is 300 mm (11.8inch). If the air return or manhole is at the right lower part of the unit, the minimum distance is 150 mm (5.9inch). When the refrigerant pipe needs to be laid at the air outlet side, avoid laying the pipe at the front of the air outlet. The refrigerant pipe cannot connect to any part of the unit except the joint points. If the preceding principles are not followed, performance of the unit will be affected and running noises will be increased.

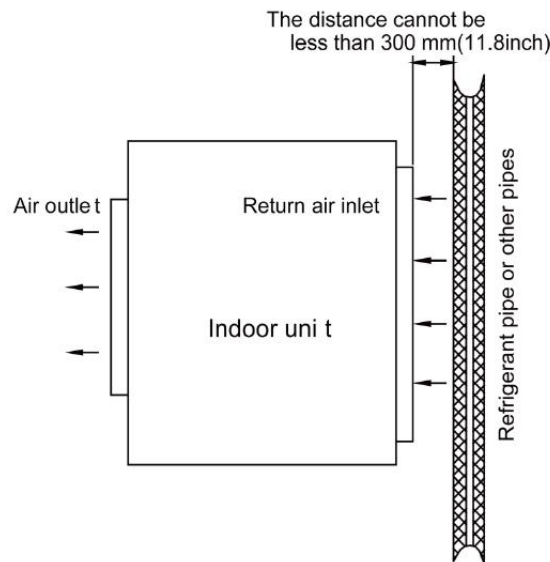

- (4) The refrigerant pipe must be laid away from the manhole of the unit so that sufficient space can be reserved for maintenance.

(5) The riser should be installed in the air conditioning tube well, and the horizontal pipe should be placed in the ceiling, if possible.



- ① Always careful not to leak the refrigerant during welding.
- ② The refrigerant generates poisonous gas harmful to human body if combusted.
- ③ Do not perform welding in a closed space.
- ④ Be sure to close the cap of the service port to prevent gas leakage after the work.

▲CAUTION

Please block the pipe knock outs of the front and side panels after installing the pipes.(Animals or foreign objects may be brought in to damage the cables.)

1.2 Processing to Refrigerant Pipes

1.2.1 Cut-off and burring

Use a special-purpose pipe cutter to cut copper pipes instead of using a hacksaw.

Cut the pipes gently to ensure that the copper pipe does not deform.

After cutting the pipes, use a slicker to grater bur the pipes with the pipe opening inclining downward so that the copper scales do not fall into the pipe.

Allowable deviation: Skewness of the cross section cannot exceed 1% of the copper pipe caliber.

If the copper pipe is not used immediately after cut-off, cover it with a sealing cap or adhesive tape.

1.2.2 Pipe cleaning

Cleaning with a piece of silk cloth: wrap a thin steel wire with a piece of clean silk cloth. Crumple the cloth into a lump with diameter larger than the pipe calibre. Apply several drops of chlorylene to the cloth. Push the cloth in from one end of the pipe and pull out from the other end. Every time the cloth is pulled out, remove the dust and sundries with chlorylene. Wash repeatedly until the pipe is clean. This method applies to straight pipes.

Cleaning with nitrogen: blow off all dust and sundries in the pipe with nitrogen. This method applies to coils.

After cleaning, cover the both ends of the pipe with a sealing cap or adhesive tape.

1.2.3 Pipe bending

Processing methods:

Manual bending: applies to thin copper pipes ($\Phi 6.35$ mm (1/4 inch) to $\Phi 12.7$ mm (1/2 inch))

Mechanical bending: applicable range ($\Phi 6.35$ mm (1/4 inch) to $\Phi 54.1$ mm (2-1/4 inch))

Requirements:

The radius of the bending pipe must exceed 3.5D. The ratio of the short diameter after bending to the original diameter must exceed 2/3.

Precautions:

During bending, there must be no corrugation or deformation inside the pipe.

The welding point of the pipe should not be at the bending part. The distance between the nozzle welding joint and the bending part should be less than 100 mm(3.94inch).

1.2.4 Pipe expanding

Pipe expanding is used to provide a welding point for pipe connection. Requirements on pipe expanding are as follows:

- (1) All burrs and sundries inside the pipe must be cleared after cut-off.
- (2) Before pipe expanding, apply appropriate amount of lubricant on the surface of the pipe. (The lubricant must meet the refrigerant system's requirements.)
- (3) Pipe expanding length must be in accordance with the insertion depth of the caliber.
- (4) To avoid leakage due to straight lines at the expanding point, turn round the copper pipe and then make corrections.
- (5) Apply appropriate force during pipe expanding to avoid crack.

1.2.5 Flaring

Another mode of pipe connection is flare opening connection, which requires pipe flaring before connection. Before pipe flaring, apply appropriate amount of lubricant on the surface of the opening to ensure smooth pass of flaring nuts and avoid pipe distortion. (The lubricant must meet the refrigerant system's requirements.) The concentricity must be ensured after pipe flaring. The sealing face must be intact without any burr, crack, or wrinkle.

Requirements on pipe flaring are as follows:

- (1) End faces of the copper pipe are smooth.
- (2) Burrs and turn ups inside the pipe opening must be cleared.
- (3) Install flaring nuts in the pipe before pipe flaring.
- (4) The flared opening must be concentric with the main pipe. No eccentricity is allowed.
- (5) Put the pipe into the root of the pipe expander.
- (6) Longitudinal cracks cannot be generated.

1.3 Installation of Refrigerant Pipes

1.3.1 Operation sequence

The sequence for installing the refrigerant pipe is as follows:

Preparing and installing the support, hanger, and bracket – Piping according to the drawing – Cleaning the pipe→Processing the pipe→Adding an insulation sleeve→Connecting the pipe→Fixing the pipe→Blowing contaminants in the pipe system→Performing a air-tightness test→Performing insulation.

1.3.2 Construction of built-in metal fittings

- (1) Construction of supports, hangers, and brackets for pipes

These parts must be fixed securely in reasonable type and style without any tilt. The surface is clean without any dirt. The parts embedded into the wall or floor cannot be painted or coated and must be free from grease stains.

- (2) Construction of fixing bolts for devices

Ensure sufficient rigidity for the devices. Take anticorrosive measures for exposed part of built-in fittings. If the foundation must be waterproof, takes waterproof measures.

- (3) Construction of steel casings

Equip a steel casing for all pipes which are led through the wall or floor. Pipe welding joints cannot be

placed inside the sleeve. The steel casing must be parallel with the bottom of the wall or floor but be 20 mm(0.8inch) or more above the bottom. The diameter of the steel casing must be determined based on the thickness of the insulation layer and the inclination degree of the condensate water pipe. Fill the gap between the pipe and the sleeve with flexible and non-flammable materials. The sleeve cannot be used as a support point of the pipe.

(4) Operation Sequence



If possible, make ink lines on the ground and project them to the top of the building.

(5) Installing Built-in Metal Fittings

Select built-in metal fittings in accordance with local regulations.

(6) Installing Expansion Bolts

Use expansion bolts when built-in metal fittings are unavailable due to design change.

▲CAUTION

- ① If the foot pedal is 2 m (6.5feets) or more from the ground, there must be three points of support.
- ② The foot pedal must be tightened securely with the ladder.
- ③ Do not perform operations on the top of the ladder.

1.3.3 Shaping and fixing of pipes

When installing refrigerant pipes, ensure that the directions and branches are correct with minimum length. Use minimum number of braze welding junctions and elbows. Alignment and insulation after installation cannot affect the pipe location and elevation. There shall not be flat bending or corrugation on the pipe after piping.

Use angle steel support, bracket, round steel hanger, U-type pipe clip, or flat steel to fix pipes outside the insulation layer. It is better that the insulation materials be not compressed to ensure good insulation.

The style and workmanship of supports, hangers, and brackets must follow the standard T616 HVAC Systems Design Handbook.

The minimum distance between supports, hangers, and brackets is listed in the table below:

External Diameter of the Pipe mm(inch)	$\Phi < 19.05(3/4)$	$41.3(1-5/8) > \Phi \geq 19.05(3/4)$	$\Phi \geq 41.3(1-5/8)$
Distance between Horizontal Pipes mm(inch)	1000(39-3/8)	1500(59)	2000(78-3/4)
Distance between Vertical Pipes mm(inch)	1500(59)	2000(78-3/4)	2500(98-1/2)

The pipe led through a wall or beam must be fixed by a support, hanger, or bracket on both ends at the position 300 mm (11-7/8inch) away from the hole.

1.3.4 Pipe connection

1.3.4.1 Flaring connection

The refrigerant pipes and IDUs are connected by using the flare opening. Therefore, the quality of

flaring connection must be ensured. The flaring depth of the bell mouth cannot be smaller than the caliber. The flaring direction must face towards the direction of medium flow. Use two torque wrenches to fasten the connection.

1.3.4.2 Socket welding

The gap between socket components should be proper to ensure that the connection will not loose from the friction surface. The flaring direction of the socket component must face towards the direction of medium flow .During pipe connect, protect the braze welding part according the length specified below:

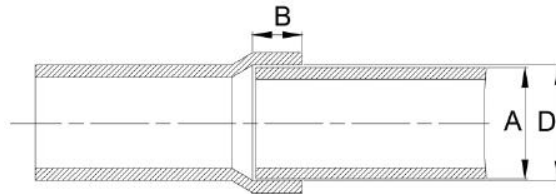

A: External Diameter of the Pipe		B: Minimum Insertion Depth		D-A: Gap between Pipes	
mm	inch	mm	inch	mm	inch
6.35	1/4	6	0.24	0.05-0.21	0.002-0.008
9.52	3/8	7	0.28		
12.7	1/2				
15.8	5/8	8	0.32	0.05-0.27	0.002-0.01
19.05	3/4	10	0.39		
22.2	7/8				
25.4	1				
28.6	1-1/8	12	0.47	0.05-0.30	0.002-0.012
31.8	1-1/4				
38.1	1-1/2	19	0.75	0.15-0.35	0.006-0.014
44.5	1-3/4				

1.3.4.3 Bell socket welding

The bell socket welding is another form of socket welding. It uses the sleeve or pipe in a larger size for welding. The insertion depth cannot be smaller than that required by socket welding.

1.3.4.4 Flange connection

The pipes with large caliber and the devices are always connected by using a flange, which must be clean and intact. Before installation, apply lubricant on the surface of the flange. Two flanges must be symmetrical. Fasten with screws at the diagonal direction to avoid inclination.

1.3.5 Welding protection

Aerate with nitrogen before and during welding and keep aerating for 30s after the welding is finished.

Equip a pressure regulator valve to the nitrogen cylinder.

The nitrogen flow is above 4-6 L/min (pressure of 0.02 to 0.05 MPa) and must be regulated based on the pipe caliber.

▲ CAUTION

● During welding, nitrogen-filling protection must be conducted; otherwise, the remaining substance in pipeline will cause blockage or leakage to the system (e.g. electronic expansion valve), which will result in abnormal operation or even damage the compressor.

1.3.6 Requirements on manifold installation

Manifolds are used to divert refrigerant. Requirements on manifold installation are as follows:

(1) Ensure that the manifold is close to the IDU to reduce impact on refrigerant assignment by IDU branches.

(2) The manifold must be that specified by the manufacture and match with the devices.

(3) Ensure that the manifold model is correct.

(4) Manifolds can be laid in the following ways:

1) Horizontal installation: The three ports must be on the same level. The shaping size and assembly angle cannot be changed.

2) Vertical installation: The direction can be upwards or downwards. Three ports must be on the same elevation without inclination.

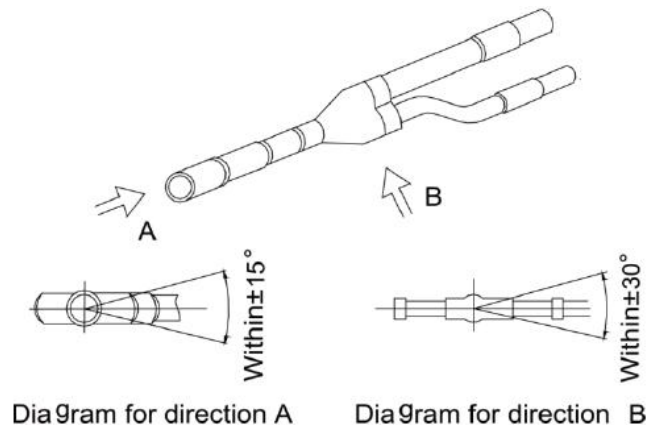

3) The length of a straight pipe between two manifolds cannot be less than 500 mm (19.7inch) .

4) The length of a straight pipe before the main pipe port of the manifold cannot be less than 500 mm (19.7inch) .

5) The length of a straight pipe between the branch of the manifold and the IDU cannot be less than 500 mm (19.7inch) .

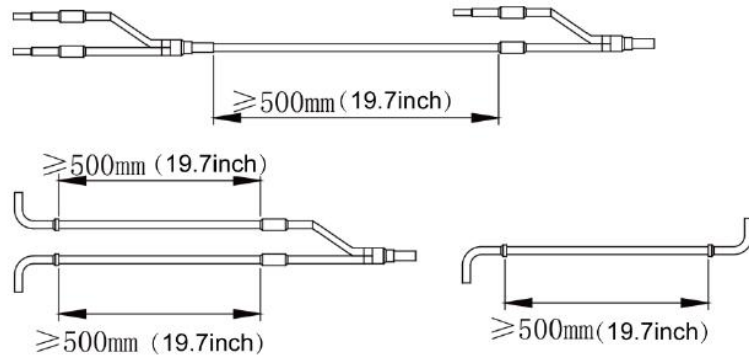

(5) Fixing of manifolds.

There must be three fixing point for both horizontal and vertical installation of the Y-type manifold.

Fixing point 1: 100 mm (3.94inch) on the main inlet manifold from the welding point.

Fixing point 2: 200 mm (7.88inch) on the main branched pipe from the welding point.

Fixing point 3: 250 mm (9.84inch) on the branched pipe from the welding point.

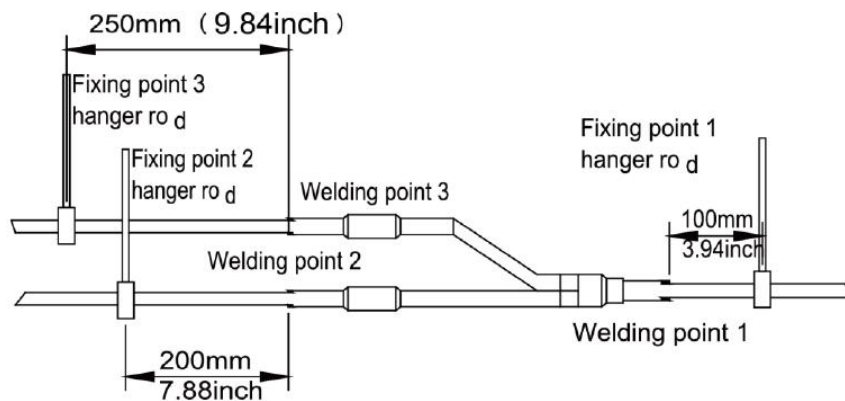

Branches of a manifold must be laid parallel and cannot be wrapped in superimposed mode.

(6) The liquid pipe and gas pipe must have the same length and be laid in the same route.

(7) The Y-type manifold has an attached pipe used to adjust the diameter of different pipes. If the pipe size on site does not match the size of the manifold junction, use the pipe cutter to cut at the middle of the pipe and remove burrs. Then insert the copper pipe to proper depth. A concave bag for positioning is available to the manifold purchased from Gree.

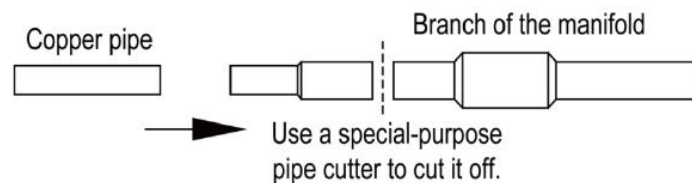
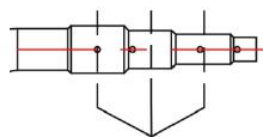

(8) Because the manifold structure is complex, perform with care to ensure tight insulation.

1.3.7 Pipe cleaning by nitrogen

Before connecting the flare opening of the pipe to the IDU, connect the pressure regulator valve on the nitrogen cylinder to the liquid pipe in the outdoor pipe system. Regulate the nitrogen pressure to about 5 kgf/cm² and blow nitrogen into the pipe for 1 minute. Repeat this operation for three times till the dirt and water are discharged. After cleaning the liquid pipe, perform the same operation to clean the gas pipe.

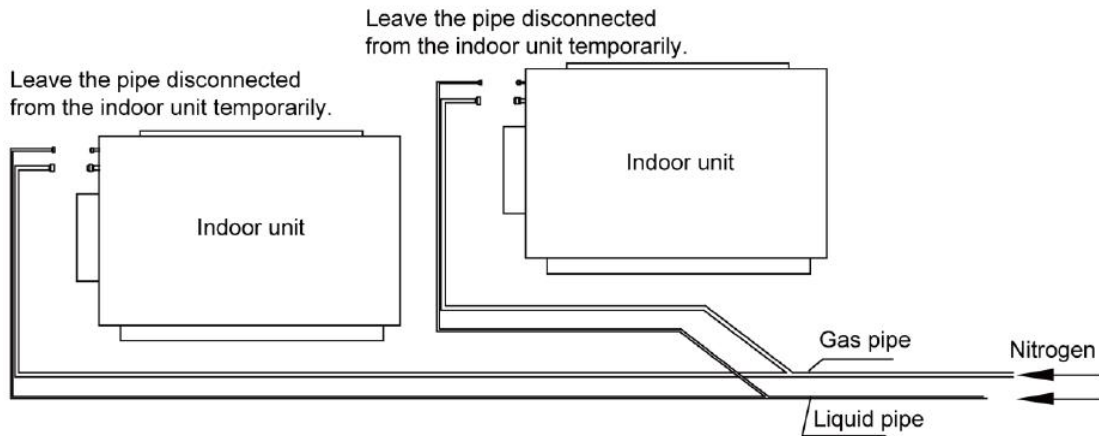

Perform an air-tightness test and a vacuum test to the entire refrigerant pipe system after the construction is finished.

There must be a secure distance between pipes. Pipes in different types must be fixed separately.

▲ CAUTION

- When all of the pipes of indoor unit finish welding, dry nitrogen must be used to blow and clean the pipes. Otherwise, the remaining substance in pipeline will cause blockage or leakage to the system (e.g. electronic expansion valve), which result in abnormal operation or even damage the compressor.

1.3.8 Refrigerant pipe installation

During refrigerant pipe installation, ensure a distance above 500 mm (19.7inch) between the pipe and the electric box of the unit for maintenance. In a case when the space is not enough, the final piping way must be determined by the technical personnel.

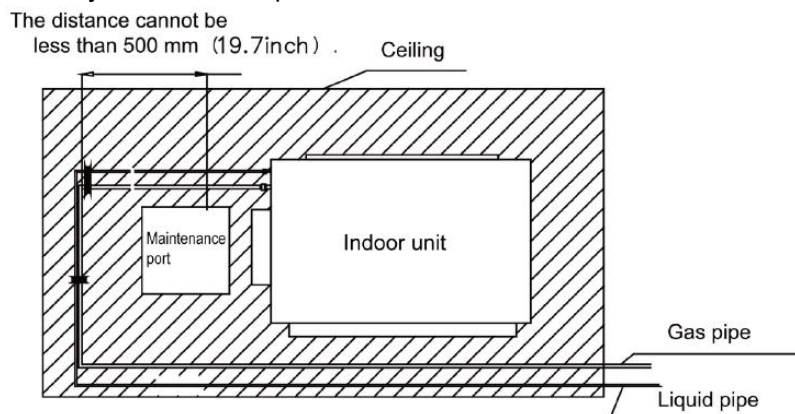

2 PIPE INSTALLATIONS FOR THE CONDENSATE WATER SYSTEM

2.1 Pipes

All of the selected condensate pipes must be consistent with local laws and regulations.

2.2 Requirements on Installation

(1) Determine the direction and elevation of a condensate water pipe before installing it. Avoid overlapping it with other pipes to ensure straight inclination. The clamp of the pipe hanger is fixed outside the insulation layer. The height of the clamp can be adjusted.

(2) Distance between Hangers

External Diameter of the Pipe	mm	≤ 25.4	$31.8 > > 25.4$	≥ 31.8
	inch	≤ 1	$1-1/4 > > 1$	$\geq 1-1/4$
Distance between Horizontal Pipes	mm	800	1000	1500
	inch	31-1/2	39-3/8	59
Distance between Vertical Pipes	mm	1500		2000
	inch	59		78-3/4

There are at least two hangers for each vertical pipe.

(3) The inclination degree of the condensate water pipe must be above 1% and that of the main pipe cannot be lower than 0.3%. Adverse slopes are not allowed.

(4) When connecting three-way pipes, the two-way straight pipes must be laid on the same slope, as shown in the following figures.

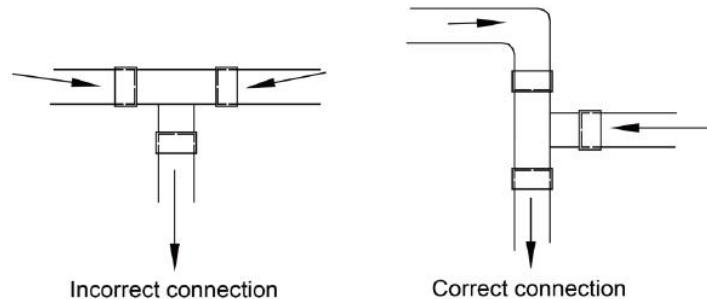

(5) The condensate water pipe cannot be tied with the refrigerant pipe.

(6) A ventilation hole must be provided on the top of the drain pipe to ensure smoother discharge of condensate water.

(7) After pipes are connected, perform a test with some water and another test with full water in the pipe to check whether drainage is smooth and whether water leakage exists in the pipe system.

(8) Equip a steel casing for all pipes which are led through the wall or floor. Pipe bonding joints cannot be placed inside the sleeve. The steel casing must be parallel with the bottom of the floor or wall. There must be a height drop of 20 mm (0.79inch) from the ground when the pipe is lead through the floor. The sleeve cannot affect the inclination degree of the pipe. Fill the gap between the pipe and the sleeve with flexible and non-flammable materials. The sleeve cannot be used as a support point of the pipe.

(9) Bond the insulation material joints with special glue and then wrap them with plastic adhesive tape. The width of the adhesive tape must be 50mm (1.97inch) or more to prevent dewing.

2.3 Other Requirements

- (1) Ensure an inclination degree of more than 1% when connecting the drain pipe to the IDU.

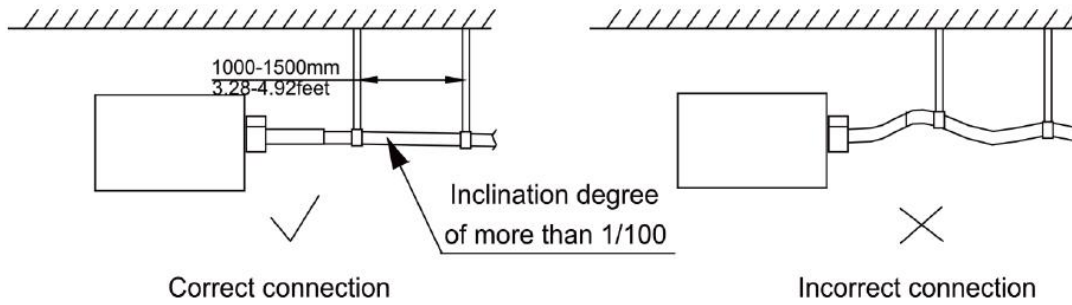

- (2) When connecting the drain pipe to that of the IDU, fix the pipes with the bands provided upon delivery instead of using the glue to facilitate further maintenance.

- (3) When connecting the drain pipe branches to the main pipe, lead through from the above part of the main pipe.

- (4) If the air volume of the IDUs is high and outdoor air resorption may be caused by negative suction pressure, provide a U-type drain trap at the water outlet side of each IDU, as shown in the following figure.

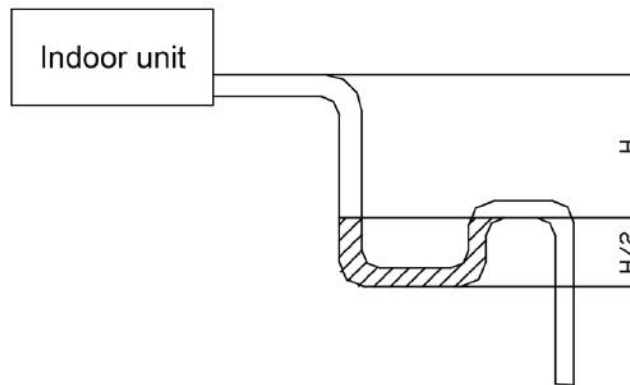

Install drain trap connectors as shown in the following figure.

Install a drain trap connector for each unit.

The drain trap connector shall be installed in a way that facilitates trap cleaning.

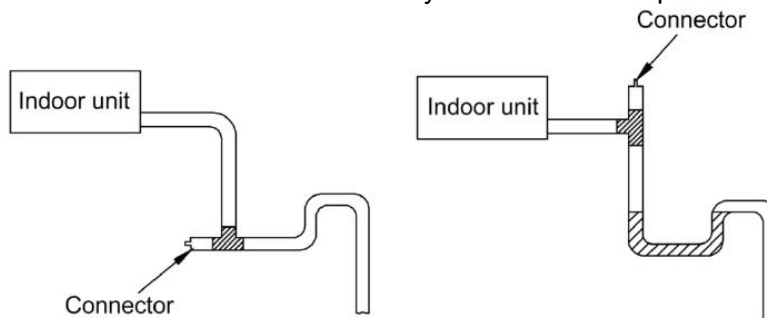

- (5) During condensate water pipe installation, ensure a distance above 500mm (19.7inch) between the pipe and the electric box of the unit for maintenance. In a case when the space is not enough, the final piping way must be determined by the technical personnel.

2.4 Requirements on Installation of Drain Pipes for Different Types of IDUs

(1) Drain Pipe Installation for Hidden Air-duct-type IDU for Air Supply

- a. Ensure an inclination degree of greater than 1% when connecting the drain pipe to the IDU.
- b. When connecting the drain pipe to that of the IDU, fix the pipes with the bands instead of using the glue to facilitate further maintenance.
- c. There is a condensate water outlet on both sides of the IDU. After one condensate water outlet is determined, use the rubber stopper to block the other outlet. Tie it with threads and strap with insulation materials to prevent leakage.
- d. The connection between the drain pipe and that of the IDU is shown in the following figure.

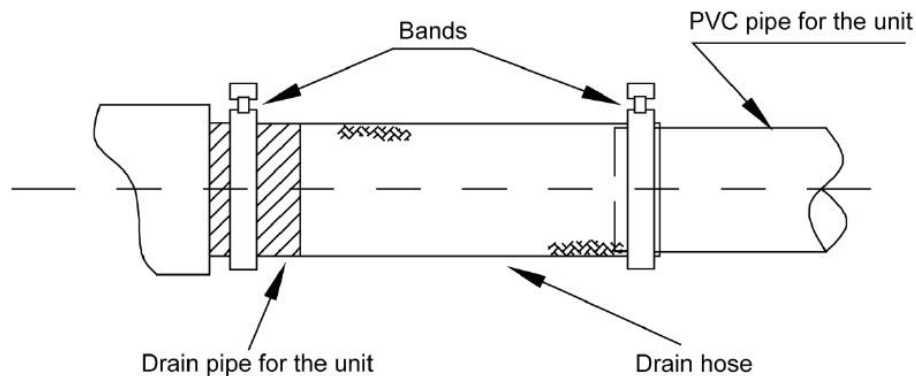

- e. Apply insulation materials to the condensate water pipe joints to prevent dewing. d. Insulation for connection between the drain pipe and that of the IDU is shown in the following figure.

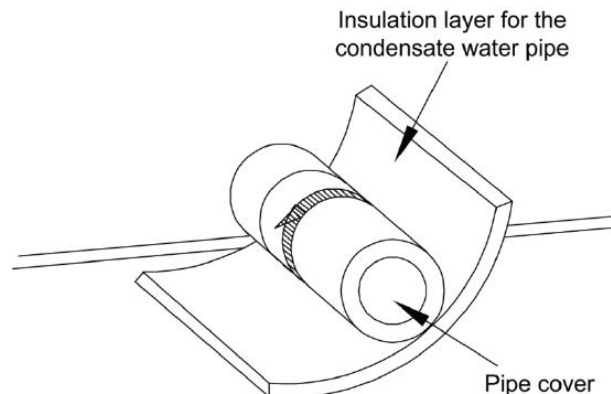

(2) Drain Pipe Installation for IDU

- a. Use pipe clips instead of applying glue to connect the hoses provided upon delivery and plastic pipes on the device. Connect the other end of the joint to the elbow. The height from the suction inlet of the discharge pump is about 200mm (7.87 inch) to 500 mm (19.7 inch). Ensure a proper inclination degree while connecting to the main drain pipe.
- b. The lifting pipe for drainage must be provided as shown in the following figure.

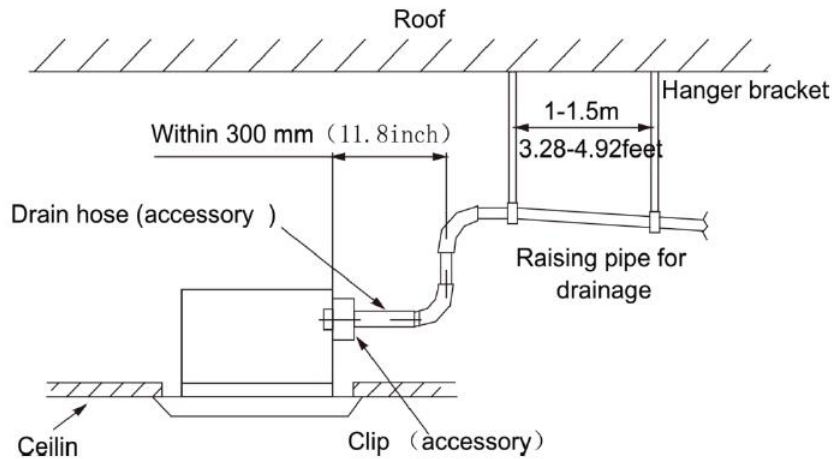

c. The drain pump shall be fixed securely. Otherwise, abnormal noises will be generated.

2.5 Requirements on Independent Drainage for Each IDU

Requirements on independent drainage design for each IDU are as follows:

- (1) There must be a proper inclination for the drain pipe.
- (2) The drain pipe must be installed to facilitate drainage to the largest extent and be as short as possible.
- (3) If the water is discharged to the outdoor side, it cannot drop to the outdoor ground directly.

2.6 Requirements on Centralized Drainage for IDUs

- (1) When there are multiple IDUs in the same building, centralized drainage is adopted.
- (2) When a header pipe is used, the drain pipe of each IDU must be higher than the header pipe.
- (3) The diameter of the header pipe must be determined on the number and capacity of IDUs.
- (4) When installing pipe, start from the highest point of the pipe and follow the specified inclination to smoothly discharge condensate water.
- (5) Connect branches to the main pipe from the upper part or side instead of lower part of the main pipe.
- (6) Insulate all condensate water pipes, especially for joints at elbows.

3 INSULATION SYSTEM

3.1 Insulation for the Refrigerant Pipe System

3.1.1 Insulation materials

Use closed-cell foam insulation materials with flame retardant grade of B1.

The heat conductivity is not greater than 0.035 w/(m·k) when the average temperature is 0°C.

3.1.2 Thickness of the insulation layer

External Diameter of the Pipe	mm	≤ 12.7	≥ 15.9
	inch	1/2	5/8
Thickness of the Insulation Layer	mm	≥ 15	≥ 20
	inch	0.59	0.79

Use sunblock, anti-weathering, and non-cracking insulation materials for outdoor pipes.

3.1.3 Procedure of insulation

- (1) Select insulation materials based on design requirements.
- (2) Wear the insulation sleeve before connecting refrigerant pipes. Users cannot cut the insulation material apart and then wrap up with ties after connecting the pipes by welding.
- (3) Specifications of the insulation sleeve must match with that of the refrigerant pipes.
- (4) Reserve a distance of about 200 mm(7.87inch) near the welding point to protect the insulation sleeve during welding. After performing the air-tightness test, perform insulation to the welding point separately to ensure continuity of the insulation sleeve.
- (5) The insulation layer cannot crack during construction. Bond the insulation material joints with special glue and then wrap them with electrical adhesive tape. The width of the adhesive tape must be 50 mm (1.97inch) or more to ensure secure connection.
- (6) Use glue to bond the insulation material at the water outlet to the unit to prevent dewing.
- (7) Wrap joints of indoor/outdoor units with insulation materials. There must be no gap between the joint and the wall of the indoor/outdoor unit, as shown in the following figure.

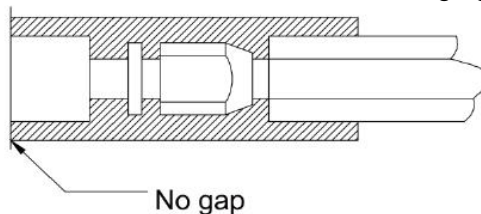

3.2 Insulation for the Condensate Water Pipe System

- (1) Thickness of the Insulation Layer
Thickness of the insulation layer for the condensate water pipe must be greater than 10 mm (0.39inch).
- (2) Bond the insulation material joints with special glue and then wrap them with plastic adhesive. The width of the adhesive must be greater than 50mm (1.97inch) to prevent dewing.
- (3) Insulation is not required for the outdoor part of condensate water pipes.

3.3 Insulation for Air Ducts

- (1) Insulation for air duct components and devices must be performed after the air leakage test is performed or after quality check.
- (2) Use centrifugal glass wool or rubber and plastic materials for insulation or use novel insulation air ducts.
- (3) The insulation layer should be flat and tight without any crack or gap.
- (4) Thickness of the Insulation Layer
For the air supply and return air pipe laid in a room without an air conditioner, thickness of the rubber and plastic insulation layer is 35 mm (1.38inch). For the air supply and return air pipe laid in an air conditioning room, thickness of the rubber and plastic insulation layer is 20 mm (0.79inch).
- (5) Supports, hangers, and brackets of the air duct must be installed outside the insulation layer. A chock must be provided between the support, hanger, or brackets and the air duct.

PART 7 ELECTRIC AND CONTROLLER INSTALLATION

▲WARNING

- ① Follow ordinance of your governmental organization for technical standard related to electrical equipment, wiring regulations and guidance of each electric power company.
- ② Make sure to use specified wires for connections so that no external force is imparted to terminal connections. If connections are not fixed firmly, it may cause heating or fire.
- ③ Make sure to use the appropriate type of overcurrent protection switch. Note that generated overcurrent may include some amount of direct current.

▲CAUTION

- ① Some installation site may require attachment of an earth leakage breaker. If no earth leakage breaker is installed, it may cause an electric shock.
- ② Do not use anything other than breaker and fuse with correct capacity. Using fuse and wire or copper wire with too large capacity may cause a malfunction of unit or fire.

1 PRECAUTION

▲CAUTION

- Both the power cable and communication cable must be connected properly. If the power cable is connected to the communication port, the main board will be burnt.

The power cable and communication cable can be identified in the following ways:

Method 1: Use sheaths in different colors.

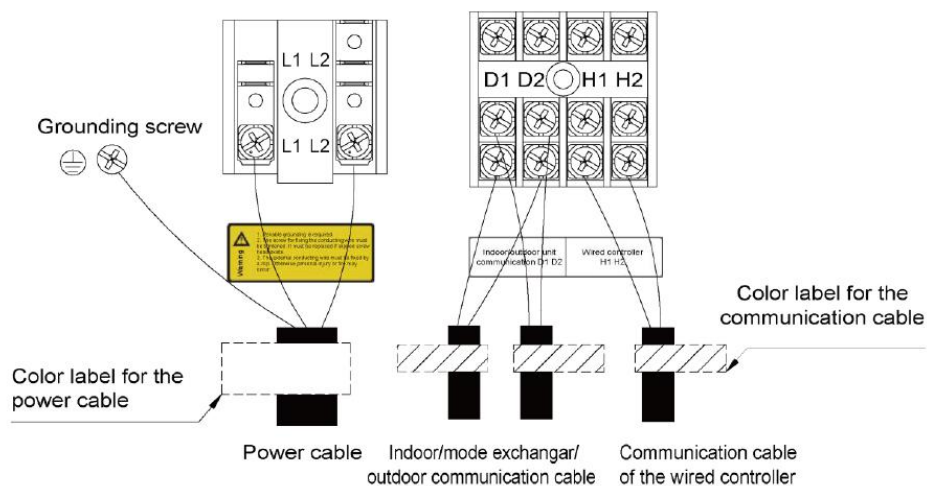

Method 2: Use different types of cables.

The diameter of the power cable is larger than that of the communication cable. Alternatively, adopt three cores or more for the power cable and two cores for the communication cable.

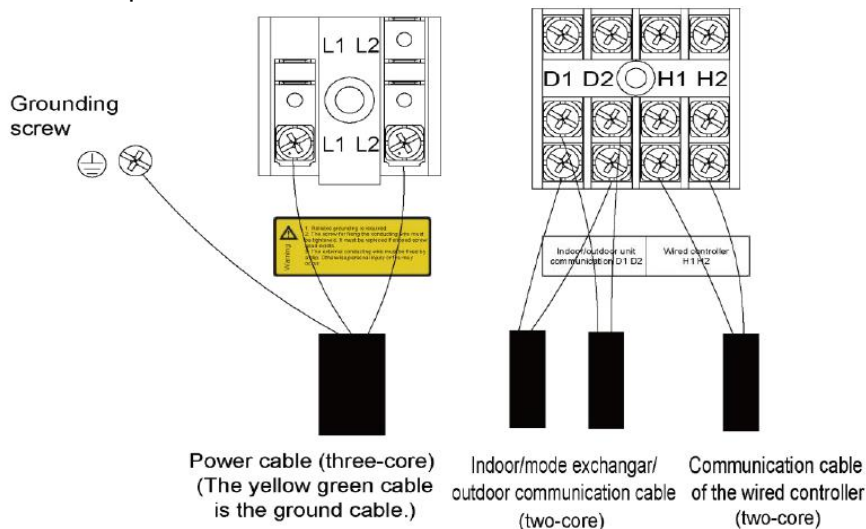

Elaborate the method with the installation personnel on site no matter which method is adopted.

2 INSTALLATION OF THE POWER CABLE

2.1 Precautions

(1) The air conditioning unit is category 1 electrical appliance which requires reliable grounding.

WARNING: be sure to have authorized electrical engineers do the electric work using special circuits in accordance with regulations and this installation manual. If power supply circuit has a lack of capacity or electric work deficiency, it may cause an electric shock or fire.

(2) The grounding resistance must comply with local rules and regulations.

CAUTION: be sure to correct the outdoor unit to earth. Do not connect earth line to any gas pipe, liquid pipe, lightning rod or telephone earth line. If earth is incomplete, it may cause an electric shock.

(3) The yellow green cable inside the air conditioning unit is a grounding cable. It cannot be used for other purposes or be cut off. Do not fix it with tapping screws. Otherwise, an electric shock may be caused.

(4) A reliable ground terminal must be provided for the power. Do not connect the grounding cable to any of the following:

a) Water pipes; b) Gas pipes; c) Drainage pipe; d) Other places deemed as unreliable.

(5) The power cable and the communication cable must be laid separately with a distance of greater than 200mm (7.87inch). Otherwise, the communication of the unit will be affection.

CAUTION: power cable and communication cable cannot come across and they should be at least 200mm (7.87 inch) away from each other, otherwise, unit may work abnormally.

2.2 Requirements on Power Cable Configuration

Configure a circuit breaker to each unit for short circuit and overload protection. In addition, configure a general circuit breaker to both the indoor and ODUs to switch on or switch off the general power of the

IDU or ODU.

1) External connection for individual unit

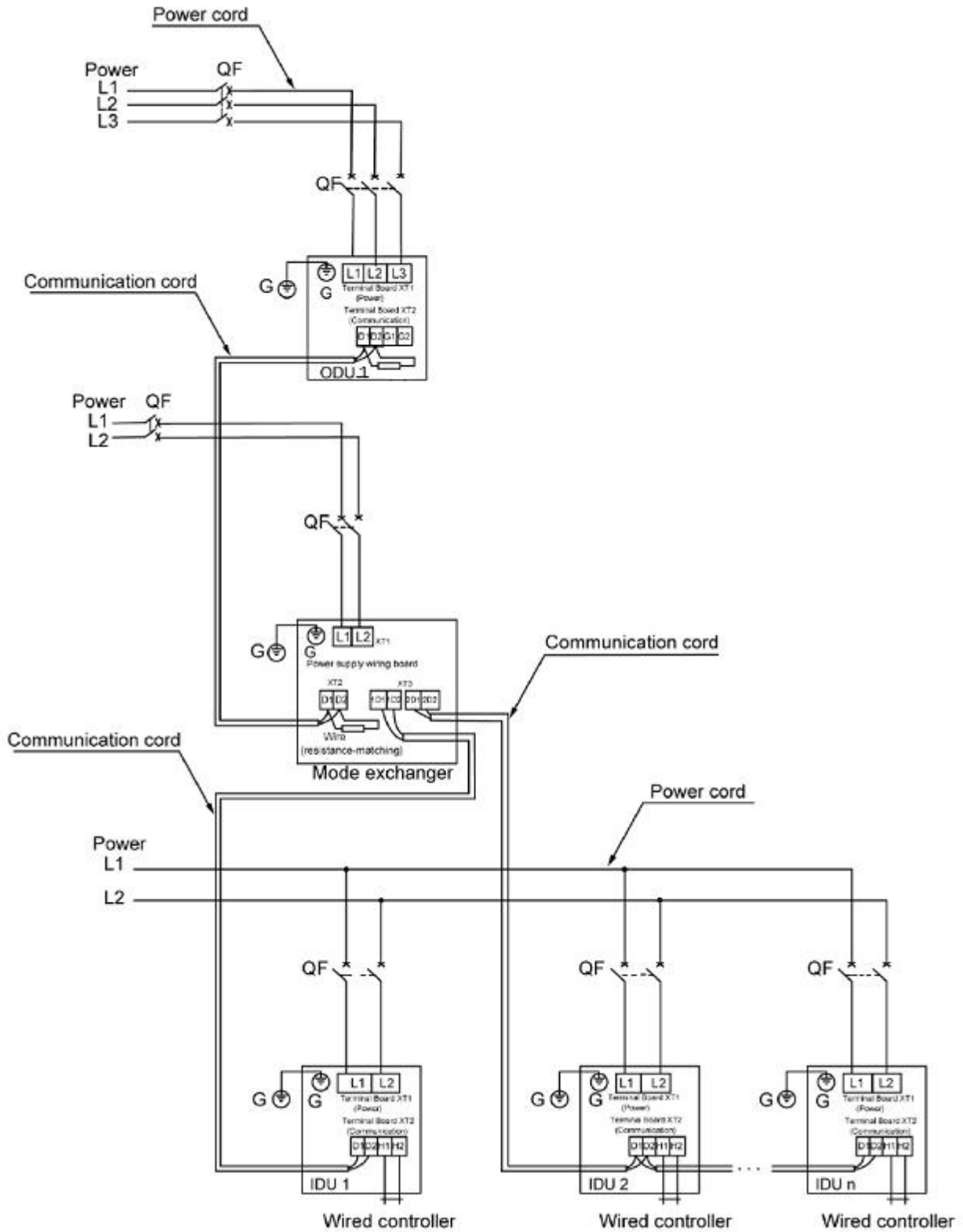

NOTICE! Maximum number of IDU is based upon ODU capacity. For details, please refer to the introduction of units' combination.

2) External connection for modular mode exchanger unit

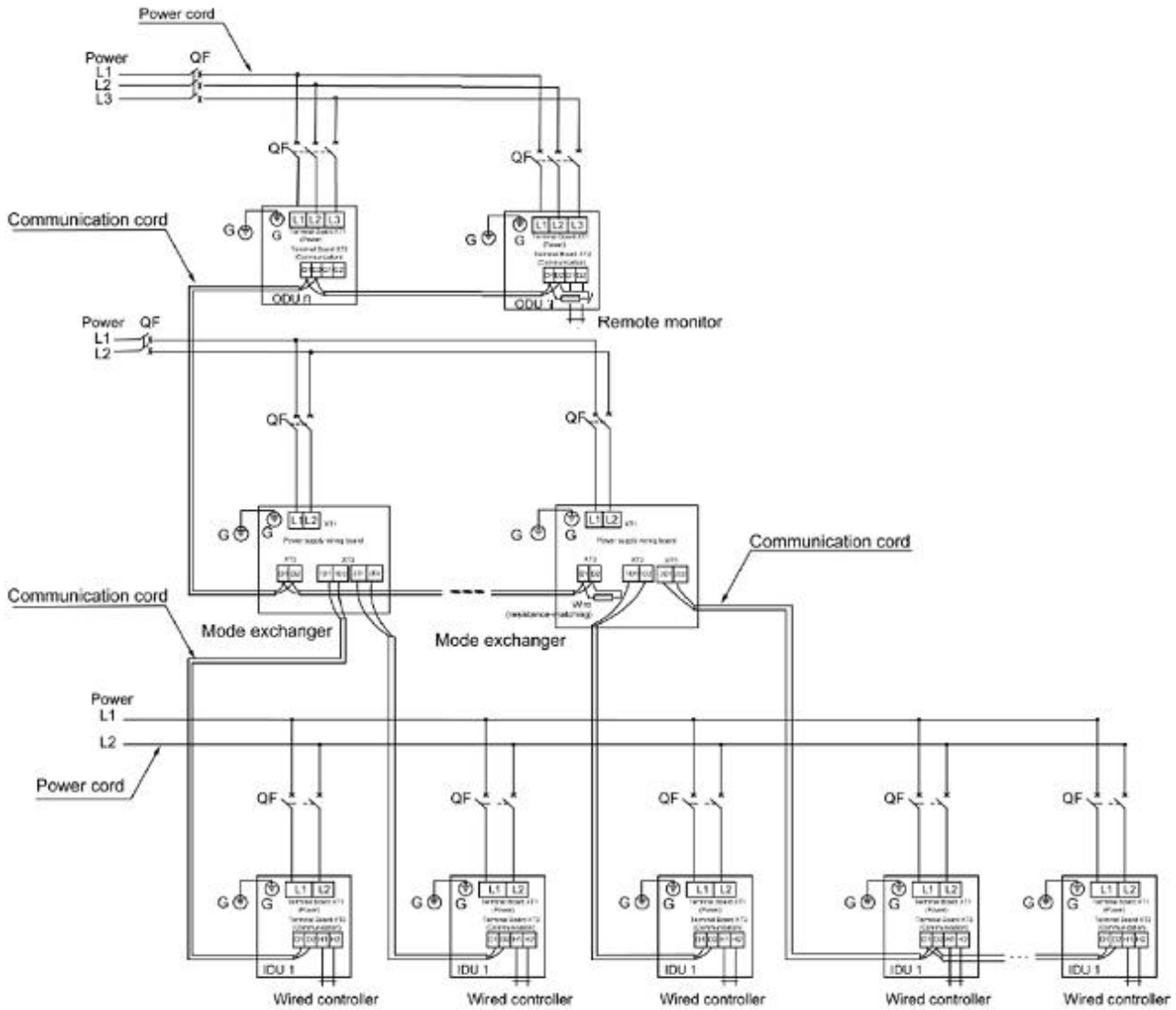

NOTICE! Maximum number of ODU (N) and maximum number of IDU (n) are based upon the combination type of ODU. For details, please refer to the introduction of unit combination.

▲WARNING

- ① Indoor Unit ground Lines are required for preventing electrical shock accident during current leakage, Communication disorder by noise effect and motor current leakage (without connection to pipe).
- ② Don't install an individual switch or electrical outlet to disconnect each of indoor unit separately from the power supply.
- ③ Install the main switch that can interrupt all the power sources in an integrated manner because this system consists of the equipment utilizing the multiple power sources.
- ④ If there exists the possibility of reversed phase, lose phase, momentary blackout or the power goes on and off while the product is operating, attach a reversed phase protection circuit locally. Running the product in reversed phase may break the compressor and other parts.

2.3 Procedure for Installing the Power Cable

(1) Knock off the knockouts used for threading the external power cable, fit the threading rubber ring to the hole, and thread the power cable through the hole. Connect L1, L2, L3, of the power cable, and the grounding cable to L1, L2, L3, on the power terminal block and the grounding screw next to the terminal block respectively.

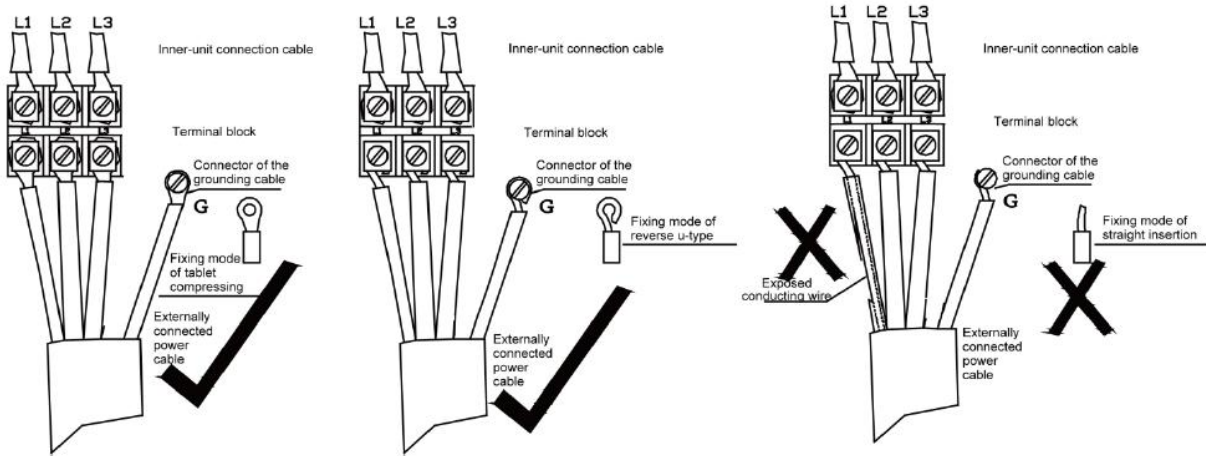

(2) Fasten and fix the power cable with ties (support heads).

(3) Lay the power cable and communication cable for the ODU according to the following figures.

NOTICE! Provide a threading rubber ring when threading a strong power cable or a communication cable.

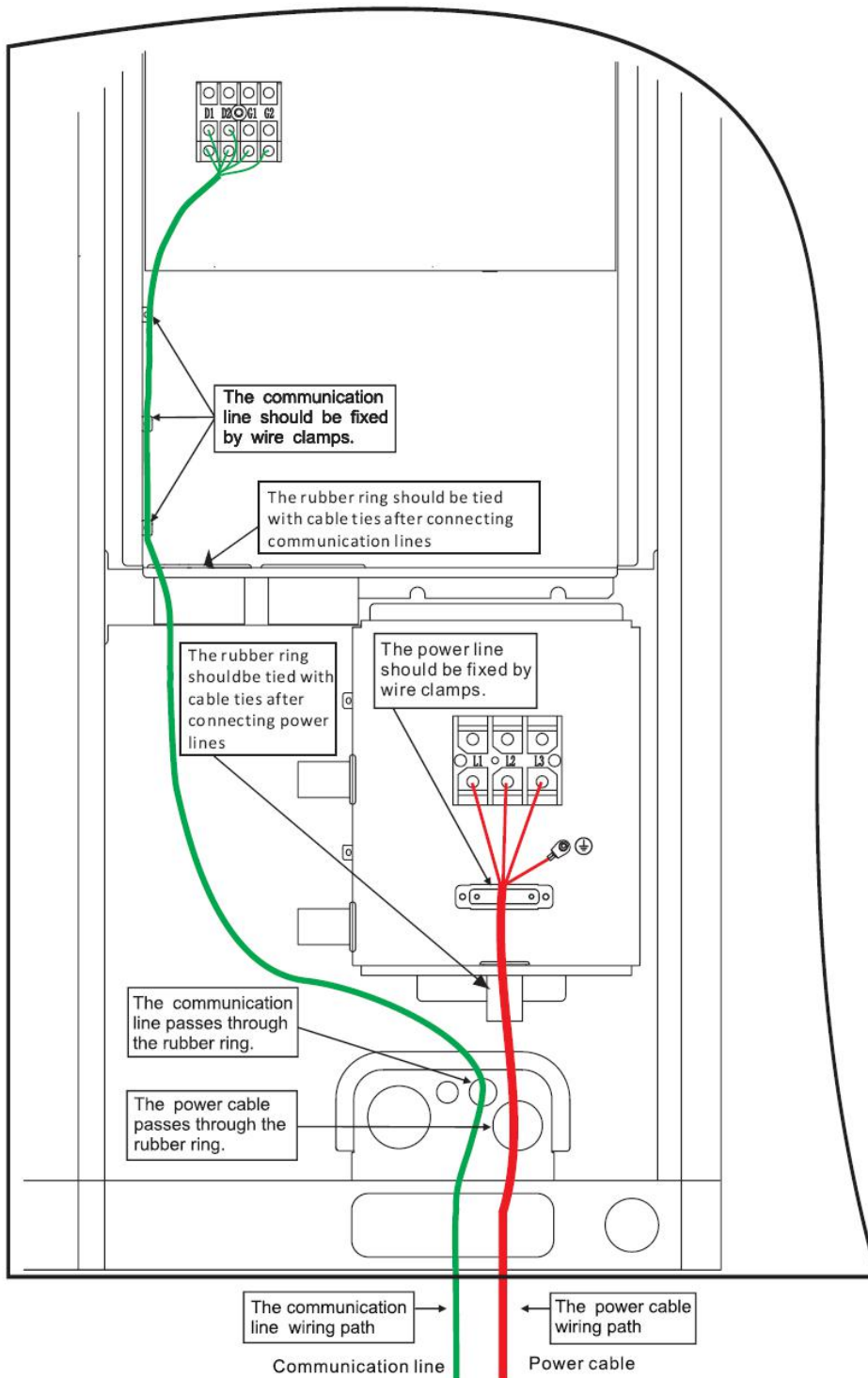

2.4 Attention before operation

The installer should read the following items, and make sure that the metal parts supplied for transportation are taken down.

1) For safe handling, two metal parts are fixed at the feet of compressor before delivery (shown as follows):

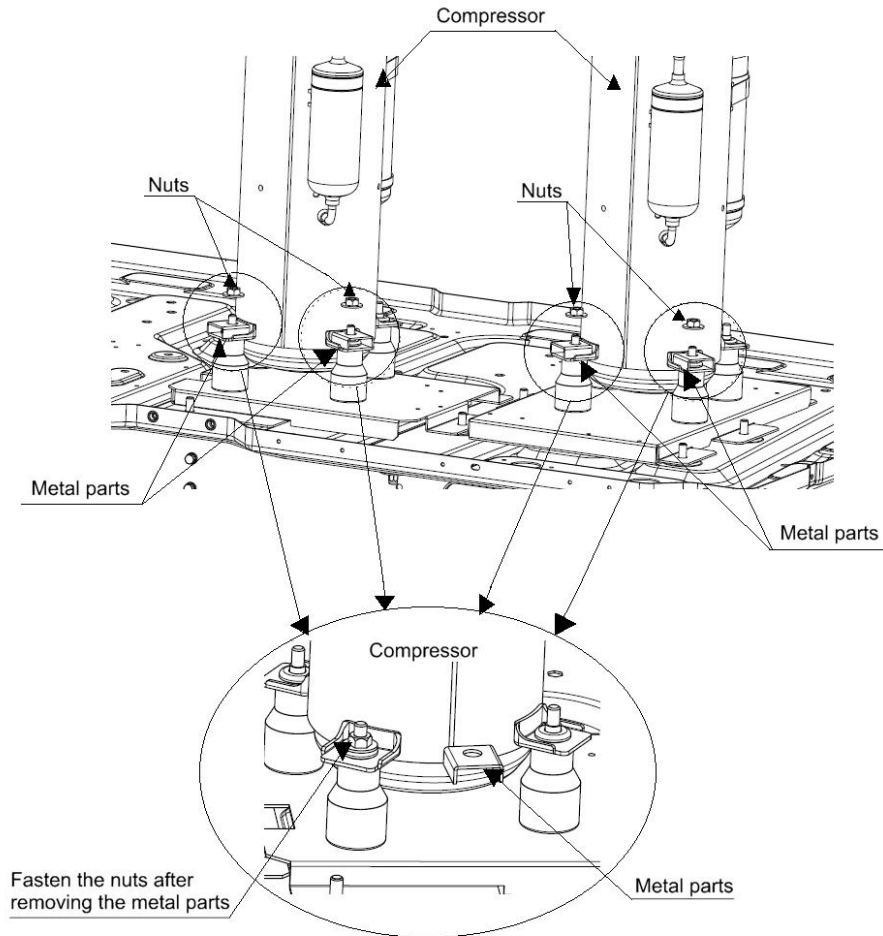

2) While installation, please make sure the metal parts are taken down. Then fasten the compressor fixed nuts again and re-wrap the soundproof material.



Note: if the unit is operating with the metal parts stay, it may lead to compressor abnormal vibration; even reduce the lifespan of the unit.

3 INSTALLATION OF THE COMMUNICATION SYSTEM

The CAN communication network is adopted for Ultra Heat GMV VRF system. Manual DIP or identification on polarities of the communication power is not required for the IDU. Only the function DIP needs to be set for the ODU. For details, see the description on function setting of the ODU.

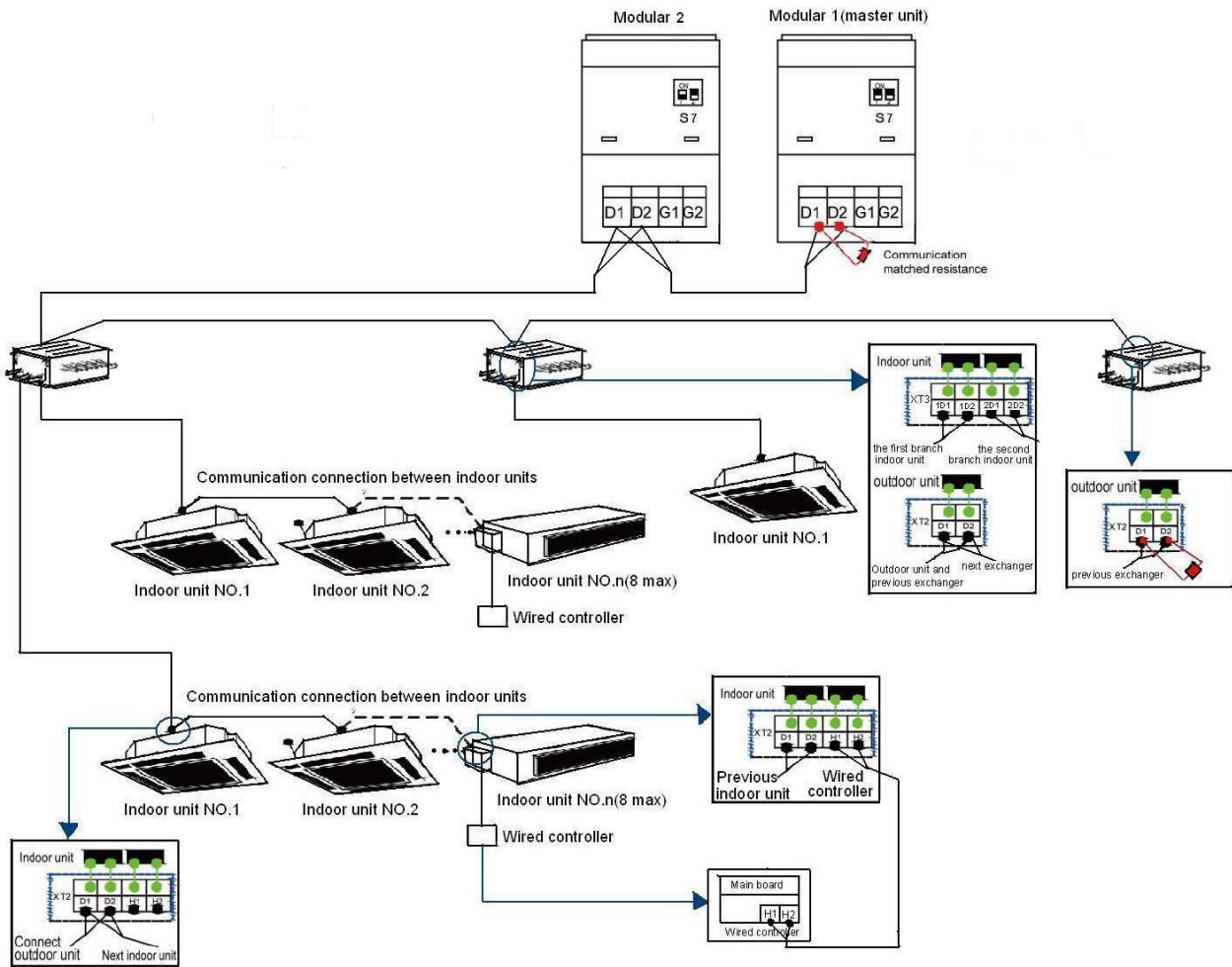

3.1 Connection of Communication Cable Terminals

All connections for communication of Ultra Heat GMV are fastened by screws.

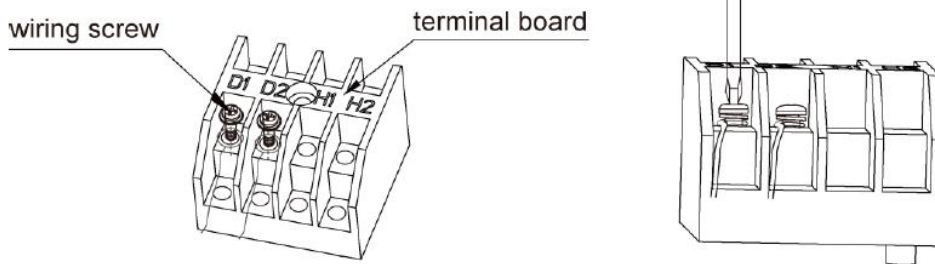

3.2 Connection of Communication Cables

The communication bus of indoor and ODUs must be connected in series instead of in star mode. The last mode exchanger of the bus shall be connected to a matching resistor (placed in the package of the ODU).

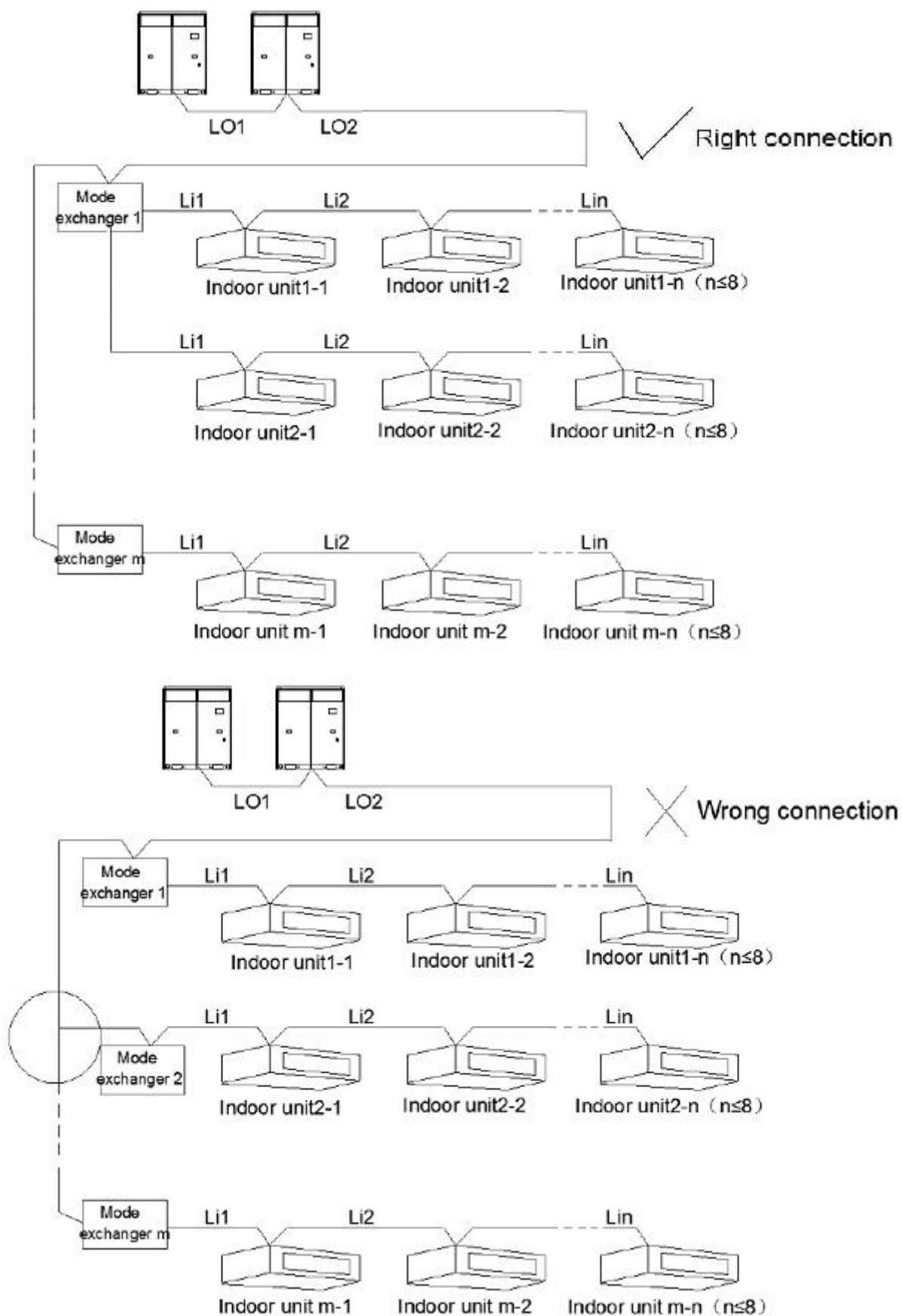

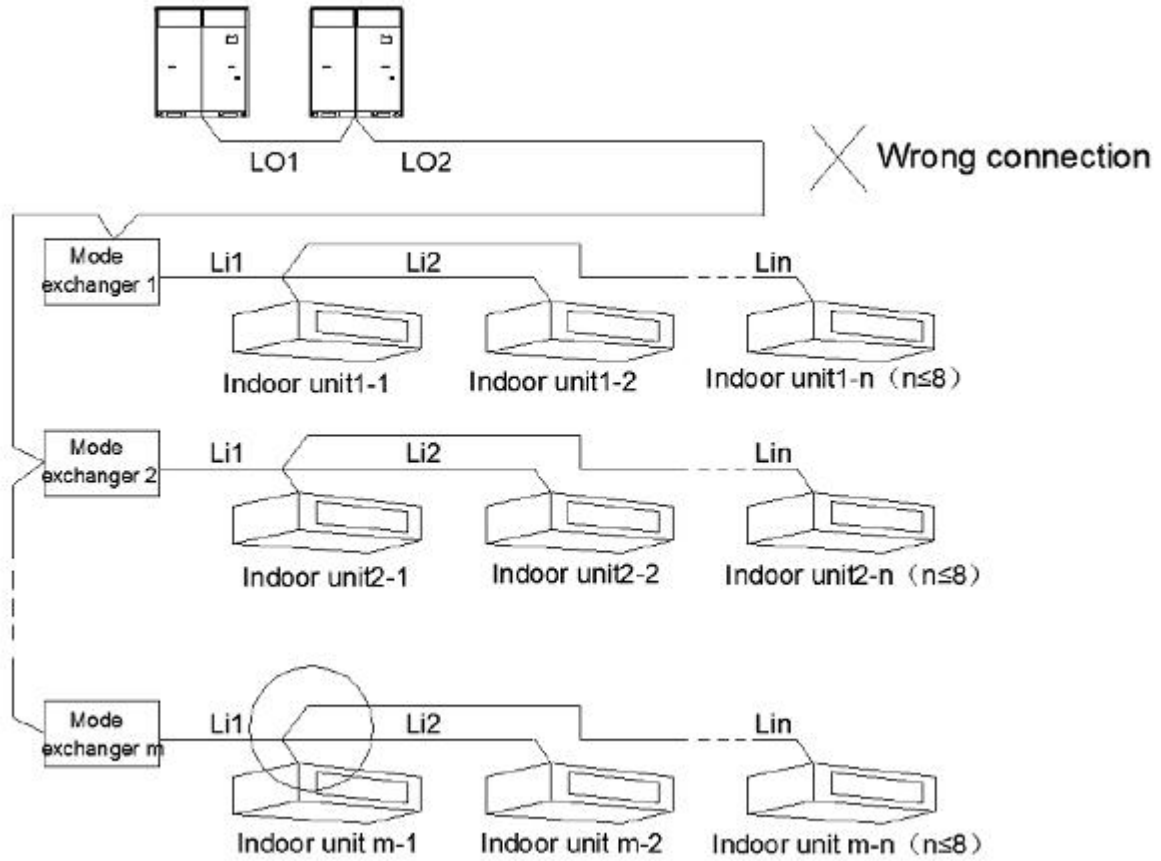

3.3 Communication Cable Connection Method and Procedure

3.3.1 Communication cable connection between the IDUs and ODUs

The communication cable between the IDUs and ODUs is connected via interface D1/D2. Connection modes for the single-module system are shown in the following figures.

Connection of communication for single-module system and single-module converter system:

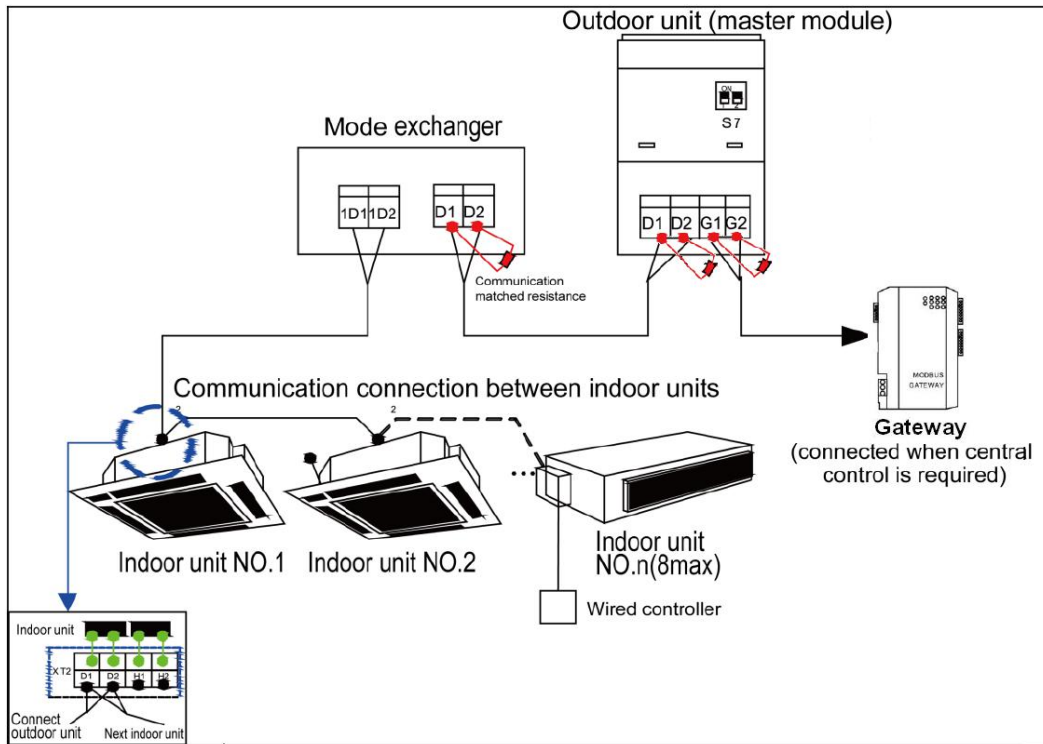

Connection of communication for multi-module converter system:

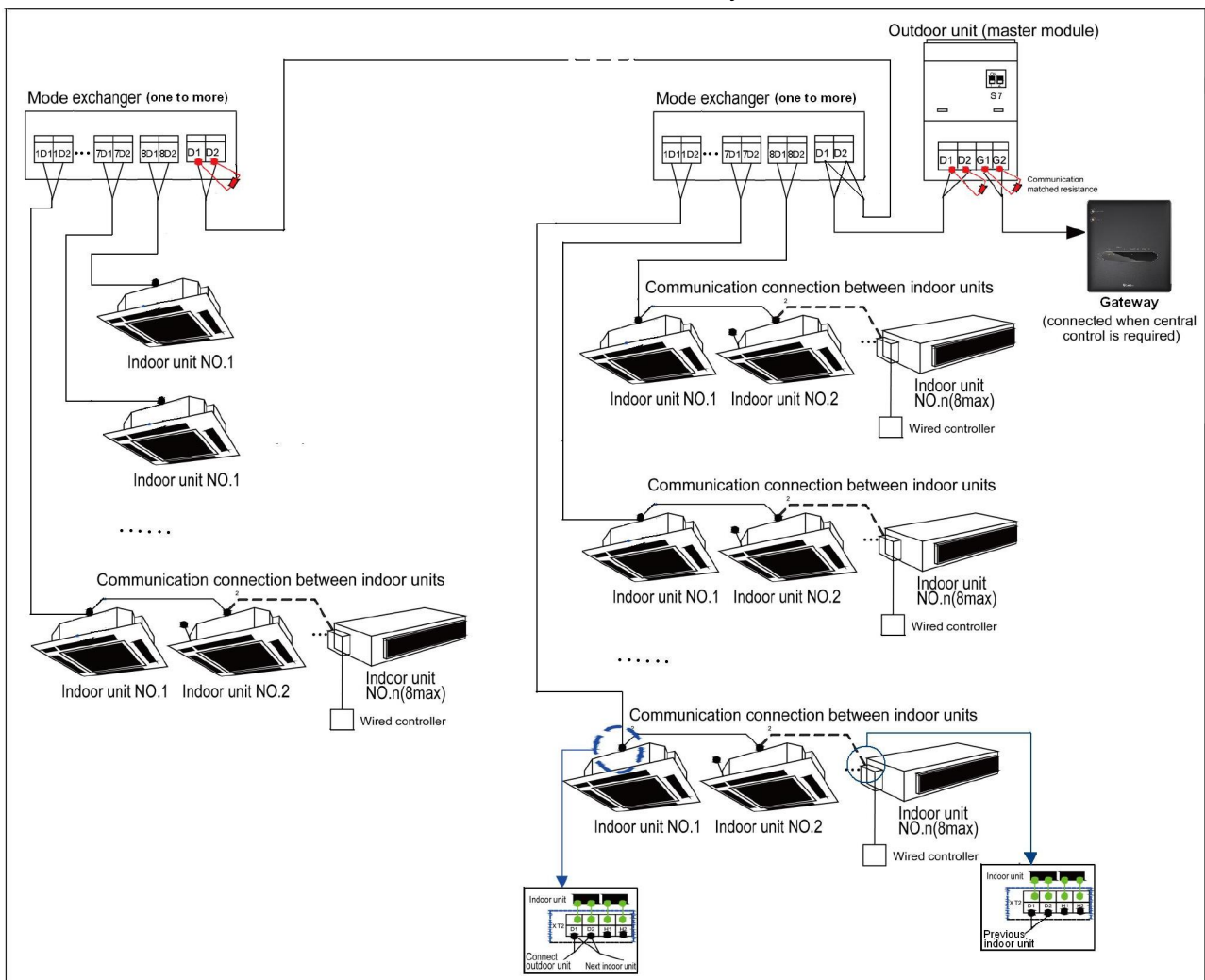

Connection of communication for multi-module system and multi-module mode exchanger system:

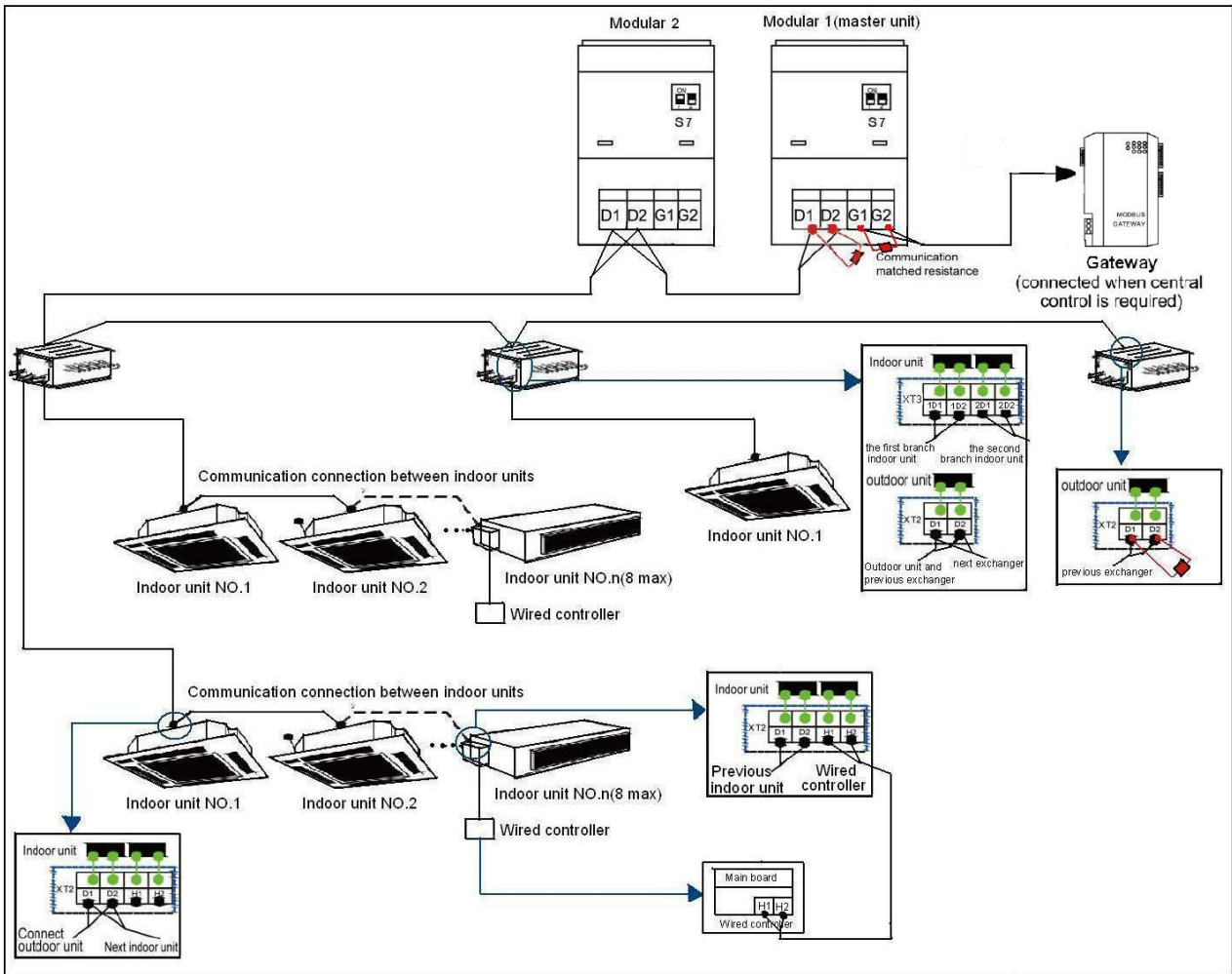

Connection of communication for multi refrigeration systems:

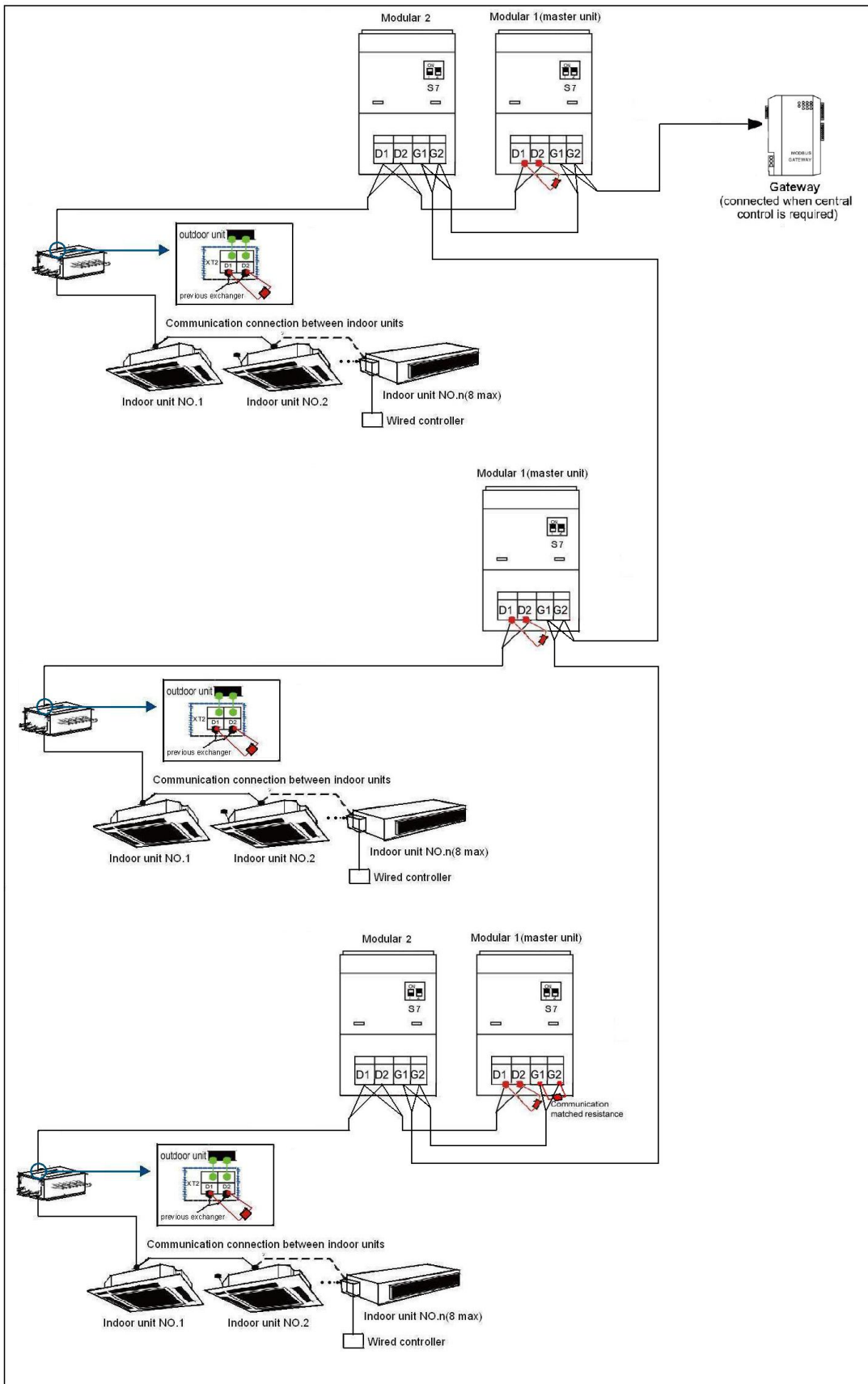

▲CAUTION

- ① For modular outdoor units, if there are multiple outdoor modules, then the master unit must be the first outdoor module on the communication wire and should not connect with IDU (master unit is set by S7 of the outdoor main board).
- ② For modular outdoor units, if there are multiple outdoor modules, then the indoor units must be connected with the last slave module of ODU (slave unit is set by S7 of the outdoor main board).
- ③ The communication cable and power cable must be laid separately to avoid interference.
- ④ The communication cable must be long enough to avoid joints.
- ⑤ Indoor units must be connected in series. The last mode exchanger shall be connected to a matching resistor (placed in the package of the ODU). The ODU D1/D2 must be connected with the communication matched resistance (installed before factory)
- ⑥ For modular outdoor units, if there are multiple outdoor modules, the communication matched resistance (installed before factory) of slave modules connecting with D1/D2 must be removed.
- ⑦ For modular outdoor units, if there are multiple outdoor modules, S7 dip switch of master unit is “00”, and S7 dip switch of slave unit is “10”, otherwise, the system main board will display CJ which means address DIP switch code of system is shocking.
- ⑧ For multi-refrigeration systems, when it is necessary to connect with a centralized controller, the communication lines connecting with all the ODUs G1/G2 must be connected in series, and the last refrigeration system master unit G1/G2 must be connected with the communication matched resistance (supplied in the list of ODU spare parts).
- ⑨ For multi-refrigeration systems, the address dip switch S3 of the master unit must be set by different numbers according to Ultra Heat technical service manual, and slave unit S3 can't be set.

3.3.2 Communication cable connection between the IDU and wired controller

Connection modes for the communication cable between the IDU and wired controller are shown in the following figures.

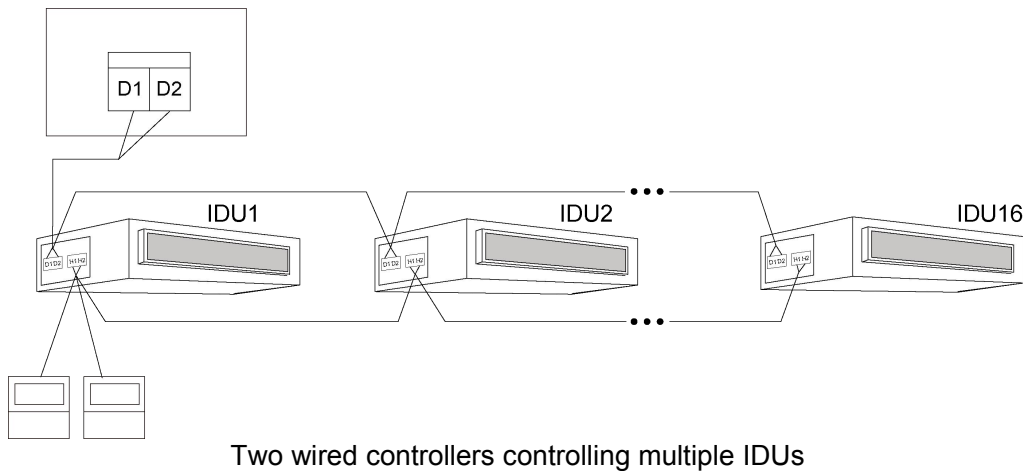
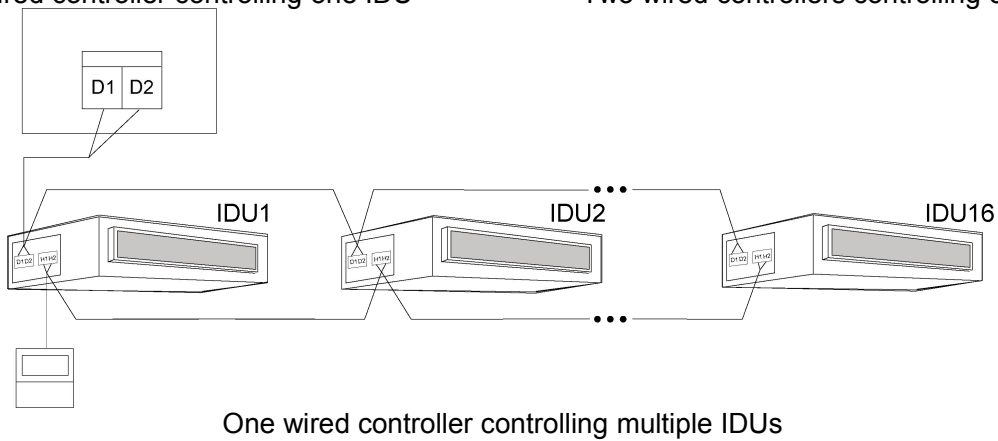
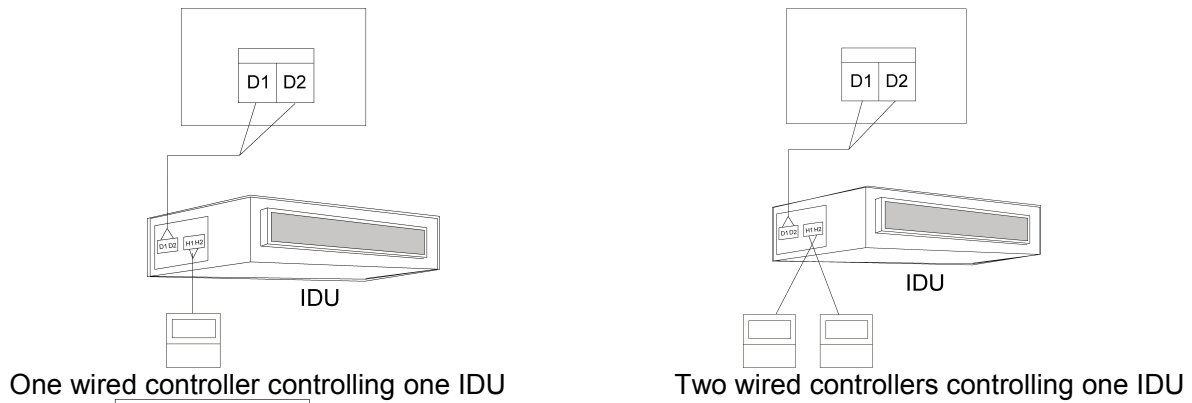

When two wired controllers control multiple IDUs, the wired controllers can be connected to any IDU which is in the same series. Set one of the two wired controller to the secondary wired controller. The number of IDUs controlled by the two wired controllers cannot exceed 16. All connected IDUs must be in the same network.

The secondary wired controller can be set in start-up or shut down mode.

(1) Press the “FUNCTION” button for 5 seconds on the wired controller to be set as the secondary wired controller. The temperature area displays “C00”. Continue to press the “FUNCTION” button for 5 seconds, the parameter setting interface is displayed and the temperature area displays “P00”.

(2) Select code P13 by pressing ▲ or ▼. Press the “MODE” button to switch to parameter value setting. When the parameter value flickers, select code 02 by pressing ▲ or ▼. Then press the —ENTER/CANCEL || button to finish setting.

(3) Users can press the “ENTER/CANCEL” button to return to the previous level till parameter setting exits. The parameter setting list is shown below:

Parameter code	Parameter name	Parameter scope	Default value	Remark
P13	Set up address for wired controller	01: master wired controller 02: slave wired controller	01	When two wired controllers control one or multiple IDUs, the addresses of the controllers must be different. The secondary wired controller (address: 02) does not support unit parameter setting except setting of its address.



NOTICE!

- ① All wired controllers are set to primary wired controllers upon delivery.
- ② In parameter setting status, Fan, Timer, Sleep, and Swing buttons are unavailable. Press the “ON/OFF” button to return to the home page without executing the action of power-on or power-off.
- ③ In parameter setting status, the remote controller signal is unavailable.

PART 8 VACUUMIZATION AND DESICCATION FOR THE REFRIGERANT SYSTEM

Works for the refrigerant system include cleaning and desiccating the pipes, performing an air-tightness test, and affusing refrigerant.

1 AIR-TIGHTNESS TEST

1.1 Importance of the Air-tightness Test

Air-tightness of the multi-module air conditioning system mainly refers to the tightness of the refrigerant pipes, which ensures secure and reliable running of the air conditioner.

Refrigerant leakage may affect functions of the air conditions or even damage the compressor and make the system to break down. Therefore, an air-tightness test must be performed. If refrigerant leakage is detected after the system is installed, it is very difficult to locate the leaking point as the suspending ceiling has been decorated. Therefore, the air-tightness test must be performed before ceiling sealing for indoor decoration is finished.

1.2 Procedure for Performing the Air-tightness Test

Stop valves of the gas and liquid pipes of the ODU are turned off at delivery.

Before test, apply a small amount of required lubricant on the block nut and pipe terminals and use two wrenches to fix the block nut.

The ODU pipes cannot be connected when the air-tightness test is being performed.

The test pressure for R410A system is 4.0 MPa. Use dry nitrogen as media for the air-tightness test. Increase the pressure slowly by following the steps below:

Step 1: Increase the pressure to 0.5 MPa. Stop for 5 minutes and then perform air-tightness check. Major leakage may be detected.

Step 2: Increase the pressure to 1.5 MPa. Stop for 5 minutes and then perform air-tightness check. Minor leakage may be detected.

Step 3: Increase the pressure for R410A system to 4.15 MPa. Stop for 5 minutes and then perform strength check. Slight leakage or blow holes may be detected. After increasing the pressure to the test pressure, keep the pressure for 24 hours and check whether it decreases. If the pressure does not decrease, it meets the requirement.

1.3 Precautions

- (1) The measuring range of the test pressure gauge for R410A system must be above 4.5 MPa.
- (2) Record the value displayed on the pressure gauge, ambient temperature, and test time.
- (3) Pressure correction: The pressure changes by 0.01 MPa when the temperature changes by 1°C.
- (4) The pressure meets the requirement if it does not change.
- (5) If the pressure must be kept for a long time, decrease the pressure to 0.5 MPa or lower. High pressure for a long time may cause leakage at the welding point or safety hazard.

(6) Before performing the air-tightness test to the refrigerant pipes, do not conduct insulation or wrapping at the welding or flaring opening joints of the IDU. The pressure must be increased simultaneously for pipes on outdoor sides and cannot be increased for pipes on one side.

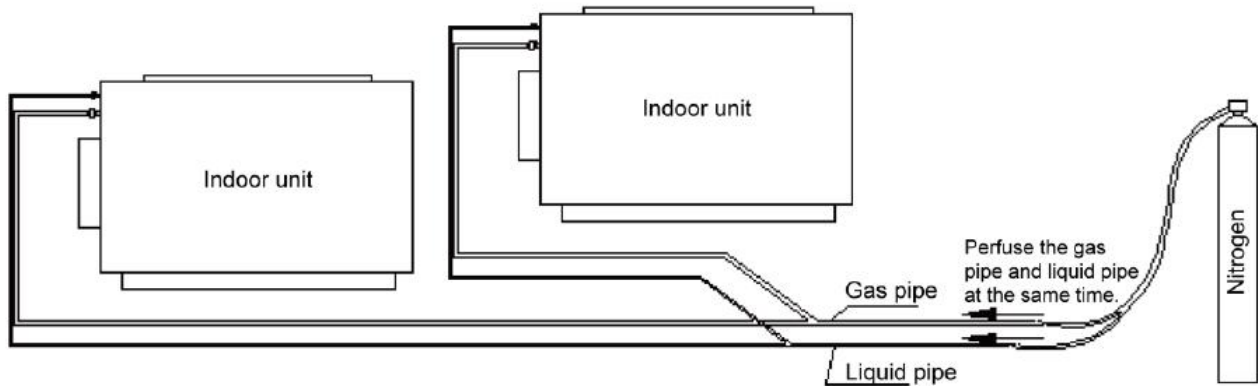

▲ CAUTION

- Before performing the air-tightness test, do not conduct insulation or wrapping at the welding joints, Otherwise, leak source cannot be detected quickly.

2 VACUUMIZATION AND DESICCATION FOR THE SYSTEM

2.1 Requirements on the Vacuum Pump

The vacuum pump for different refrigerant systems cannot be the same.

The ultimate vacuum degree of the vacuum pump should reach -0.1 MPa.

The air discharge capacity of the vacuum pump must be greater than 4 L/S.

The precision of the vacuum pump must be greater than 0.02 mmHg.

The system vacuum pump must be equipped with a check valve.

2.2 Procedure and Precautions for Vacuumization and Desiccation

2.2.1 Procedure

- (1) Before vacuumization, ensure that the stop valves of the gas and liquid pipes are turned off.
- (2) Use the perfusing duct to connect the regulator valve and vacuum pump to detection connectors of the gas pipe and liquid pipe.
- (3) Vacuumize for 4 hours and check whether the vacuum degree reaches -0.1 MPa or more. If not, leakage may exist. Perform leakage check again. If no leakage exists, continue to vacuumize for 2 hours.
- (4) If the vacuum degree cannot be kept after vacuumization is performed for twice, there may be water in the pipe when it is confirmed that no leakage exists. In this case, discharge water by means of vacuum breaking. Perfuse nitrogen at 0.05 MPa to the pipe. Vacuumize for 2 hours and keep vacuuming for 1 hour. If the vacuum degree of -0.1 MPa cannot be reached, repeat this operation till water is

discharged.

(5) After vacuumization, turn off the regulator valve and keep for 1 hour. Ensure that the pressure of the regulator valve does not increase.

2.2.2 Precautions

(1) Before vacuum pumping, make sure that outdoor unit's liquid valve, high pressure gas valve and low pressure gas valve are completely closed. Use vacuum pump to extract air inside indoor unit and connection pipe from the nozzles of liquid valve, high pressure gas valve and low pressure gas valve of outdoor unit, as shown in follow figure.

(2) Because air extraction from outdoor unit's liquid valve, high pressure gas valve and low pressure gas valve must be performed simultaneously, 2 sets of vacuum pump must be used at the same time to guarantee the required vacuum degree.

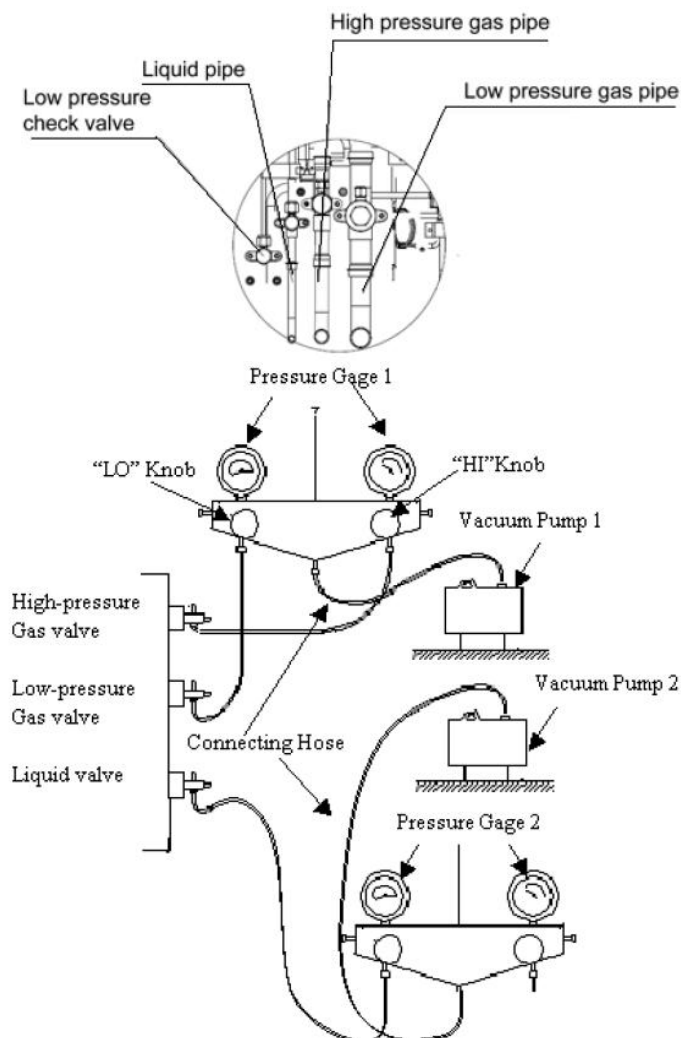

(3) Turn off the valve before powering off the vacuum pump.

(4) Keep vacuuming for 2 hours. The vacuum meets the requirement if the pressure displayed by the vacuum gauge does not increase.

(5) The units parallel connected to the module also need to be vacuumized.

PART 9 REFRIGERANT PERFUSION

1 CALCULATION METHOD FOR PERFUSING REFRIGERANT

Outdoor unit has been charged refrigerant before delivery.

If field-installed connecting pipeline is longer than 1m(39-3/8inch), please refer to the following table for charging amount of refrigerant. (Liquid pipe prevails)

Total refrigerant charging amount $R =$ Pipeline charging amount $A + \sum$ charging amount B of every module

(1) Pipeline charging amount

Added refrigerant quantity A for piping = Added refrigerant quantity $A1$ for liquid piping + Added refrigerant quantity $A2$ for high pressure gas piping

Added refrigerant quantity $A1$ for liquid piping = \sum Liquid pipe length \times Added refrigerant quantity for each meter (inch) of liquid pipe

	Diameter of liquid pipe mm(inch)							
	28.6(1-1/8)	25.4(1)	22.2(7/8)	19.05(3/4)	15.9(5/8)	12.7(1/2)	9.52(3/8)	6.35(1/4)
kg/m	0.680	0.520	0.350	0.250	0.170	0.110	0.054	0.022
OZ/inch	0.61	0.47	0.31	0.22	0.15	0.10	0.05	0.02

Added refrigerant quantity $A2$ for high pressure gas piping = \sum high pressure gas pipe length \times Added refrigerant quantity for each meter (inch) of high pressure gas pipe

	Diameter of high pressure gas pipe mm(inch)						
	28.6(1-1/8)	25.4(1)	22.2(7/8)	19.05(3/4)	15.9(5/8)	12.7(1/2)	
kg/m	0.054	0.046	0.032	0.024	0.017	0.009	
OZ/inch	0.048	0.041	0.029	0.022	0.015	0.008	

Note: high pressure gas pipe lengths means all the lengths between ODU and mode exchangers.

(2) \sum Refrigerant charging amount B of every module

Refrigerant charging amount B of every module kg(lb)		Rated Capacity(1000Btu/h)	
IDU/ODU rated capacity collocation ratio C	Quantity of included IDUs(N)	72	96
50% $\leq C \leq 90\%$	$N < 4$	0	0
	$N \geq 4$	0.5(1.1)	1(2.2)
90% $< C \leq 105\%$	$N < 4$	0	0.5(1.1)
	$8 > N \geq 4$	0.5(1.1)	1.5(3.3)
	$N \geq 8$	2(4.4)	3(6.6)
105% $< C \leq 135\%$	$N < 4$	0.5(1.1)	1(2.2)
	$8 > N \geq 4$	2.5(5.5)	3.5(7.7)
	$N \geq 8$	4(8.8)	5(11.0)

For example 1:

The OUD is GMV-VQ192WM/A-F(U) including GMV-VQ96W/A-F(U) and GMV-VQ96W/A-F(U). The IDUs are made up of 10 sets of GMV-ND18PHS/A-T(U).

IDU/ODU rated capacity collocation ratio $C=18 \times 10 / 192 = 94\%$. The quantity of included IDUs is more than 8 sets. Please refer to the above table.

Refrigerant charging amount B for GMV-VQ96W/A-F(U) module is 3kg (6.6 lbs).

Refrigerant charging amount B for GMV-VQ96W/A-F(U) module is 3kg (6.6 lbs).

Suppose the Pipeline charging amount A=Added refrigerant quantity A1 for liquid piping + Added refrigerant quantity A2 for high pressure gas piping=25kg (55.1 lbs)

Total refrigerant charging amount $R=25+3+3=31\text{kg}$ (55.1+6.6+6.6=68.3 lbs).

For example 2:

The ODU is GMV-VQ72W/A-F(U). The IDUs are made up of 1 set of GMV-NDX72P/A-T(U).

IDU/ODU rated capacity collocation ratio $C=0/72=0\%$. Refrigerant charging amount B for GMV-VQ72W/A-F(U) module is 0kg (0 lbs).

Suppose the Pipeline charging amount A=Added refrigerant quantity A1 for liquid piping + Added refrigerant quantity A2 for high pressure gas piping=25kg (55.1 lbs)

Total refrigerant charging amount $R=25+0=25\text{kg}$ (55.1+0=55.1 lbs).

After confirming that there is no leakage from the system and the compressor is not in operation, charge additional R410A with specified amount to the unit through the filling opening of the liquid pipe valve of the outdoor unit. If required additional refrigerant cannot be quickly filled for increase of pressure in the pipe, set the unit at cooling startup and then fill the refrigerant from gas valve of outdoor unit. If ambient temperature is low, the unit can't be set to cooling mode but heating mode.

▲ CAUTION

- Refrigerant amount must be calculated and treated by strictly following the above methods. Otherwise, system will not work normally and compressor may even be damaged.
- Rated capacity configuration ratio C of outdoor/indoor unit = Rated Cooling capacity sum of indoor units / Rated Cooling capacity sum of outdoor units
- If all the indoor units are GMV-NDX series fresh air indoor units, the added refrigerant quantity B for every module is 0 kg (bound).

2 METHOD FOR PERFUSING REFRIGERANT

Refrigerant perfusion for the VRF system is classified into pre-perfusion and perfusion during running.

2.1 Refrigerant Pre-perfusion

Step 1: Connect the high pressure gauge pipe to the detection opening of the liquid pipe, and the medium gauge pipe to the vacuum pump. Power on the vacuum pump to perform vacuumization and

desiccation.

Step 2: After vacuumization and desiccation are finished, turn off valves of the high pressure gauge and low pressure gauge. Disconnect the medium gauge pipe from the vacuum pump and connect it to the refrigerant tank.

Step 3: Properly loosen the joint between the medium gauge pipe and the pressure gauge and slightly turn on the valve of the refrigerant tank. Vacuumize the medium gauge pipe. After that, fasten the joint and turn on the valve of the refrigerant tank completely.

Step 4: If the refrigerant tank is not equipped with a siphon, reverse the refrigerant tank and place it on the electronic scale. Then record the current weight (m1). If the refrigerant tank is equipped with a siphon, record the current weight (m1) directly.

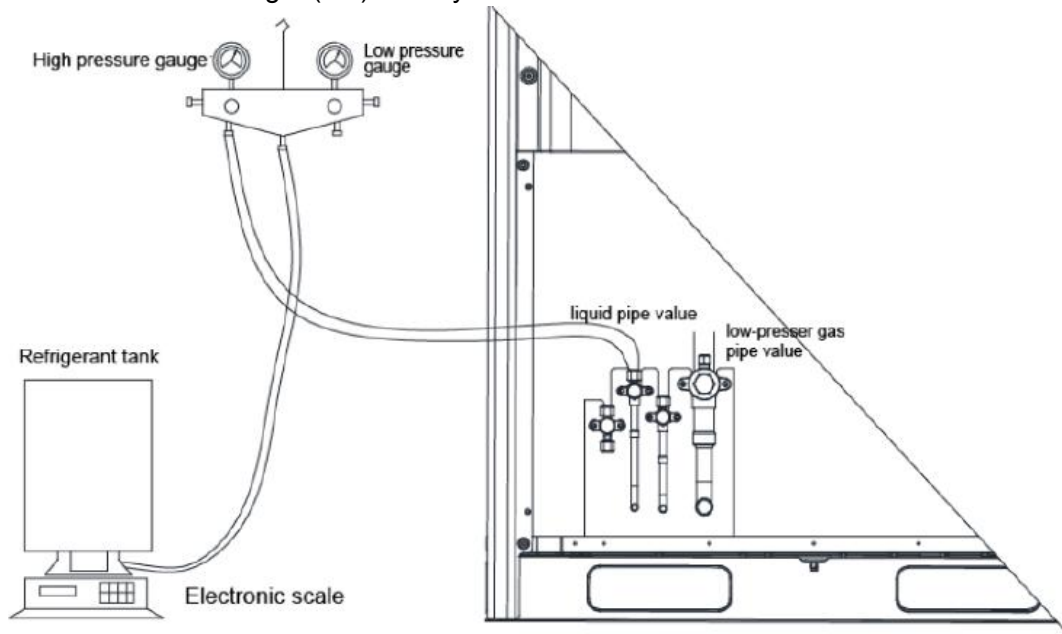

Step 5: Turn on the valve of the high pressure gauge (while keep the valve of the high pressure gauge turned off) and then perfuse refrigerant to the system. Record the change of weight of the refrigerant tank.

Step 6: When all refrigerant in the refrigerant tank is perfused, record the current weight m2.

Step 7: Turn off the valve of the high pressure gauge and replace the refrigerant tank.

Step 8: Perform step 3 again.

Step 9: Perform step 5 and step 6 again. Record the weight before perfusion m3 and weight after perfusion m4.

Step 10: If there is no sufficient refrigerant and the calculated quantity of refrigerant is not fulfilled for the system, record the current total perfusion quantity.

$$m = (m1 - m2) + (m3 - m4) + \dots + (m_{n-1} - m_n)$$

Quantity of refrigerant to be perfused during running $m = M - m$

M is the required total quantity

If the pre-perfusion quantity (m) reaches the required total quantity for the system, turn off the valve of the refrigerant tank immediately to finish perfusing and proceed with step 11.

Step 11: Remove the pressure gauge.

2.2 Refrigerant Perfusion During Running

Step 1: Turn off the valve of the refrigerant tank and reconnect the pressure gauge pipe. Disconnect the low pressure gauge pipe from the detection valve opening of the gas pipe and connect it to the low pressure check valve, as shown in the following figure.

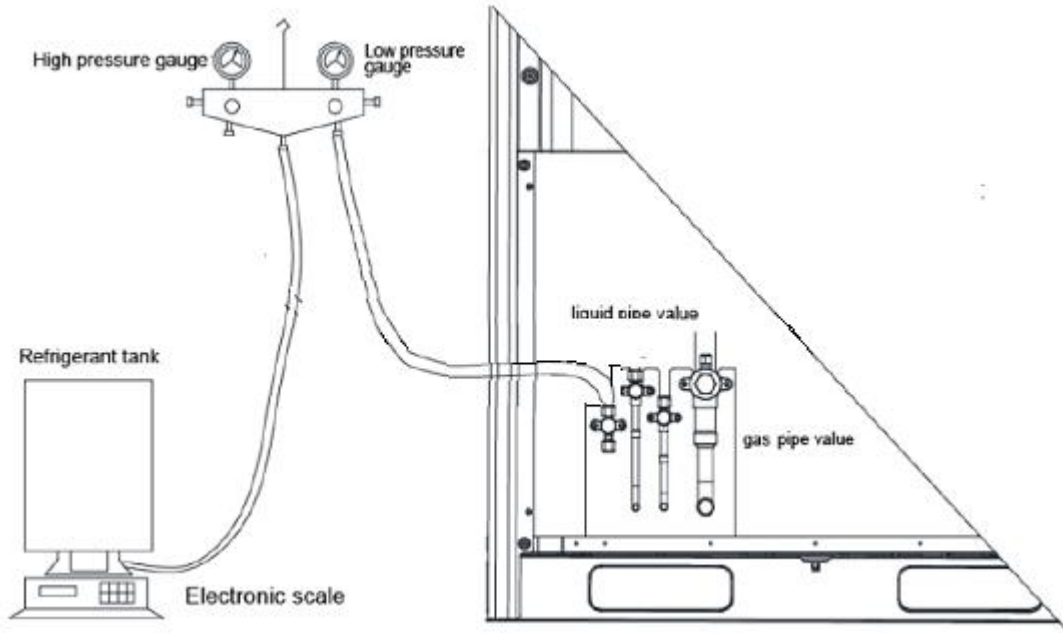

Step 2: Turn on the valves for the liquid and gas pipes of each module completely.

Step 3: Make the system to run in commissioning mode via the commissioning software or the main board of the ODU. (For details, see the description on commissioning.)

Step 4: When the commissioning step goes to refrigerant perfusion, turn on the valve of the refrigerant tank and perfuse the remaining quantity.

Step 5: After all refrigerant is perfused, turn off valve of the refrigerant tank and wait till commissioning is automatically is completed for the system.

Step 6: Remove the pressure gauge to finish refrigerant perfusion.

⚠ CAUTION

- Because R410A is a mixture of refrigerant, therefore, it must be charged in a liquid form. Otherwise, unit will not work stably and effectively.
- Do not expose the R410A refrigerant tank to direct sunlight. Otherwise, the internal pressure may get too high and cause explosion.
- Pipeline for the R410A refrigerating system must have relevant valid certificates.
- During welding, avoid overheating the pipeline.
- System must not filled with refrigerant other than R410A.

▲WARNING

- Pipe to be vacuumed : gas pipe, water pipe, common pipe
- If the refrigerant amount is not exact, it may not operate properly.
- If additionally bottled refrigerant amount is over $\pm 10\%$, condenser burning or insufficient indoor unit performance may be caused.

CHAPTER 3 COMMISSIONING OPERATION

CHAPTER 3 COMMISSIONING OPERATION

PART 1 SECURITY REQUIREMENTS

1 PRECAUTIONS FOR CONSTRUCTION

▲WARNING

- All commissioning and maintenance personnel must learn and strictly comply with construction security specifications. Security measures must be taken especially for outdoor operations.
- Workers of special types of labor, such as refrigerating engineers, electricians, and welders, must have professional certificates. No worker is allowed to do another type of labor.
- The equipment must be powered off before relevant operations, and other security requirements should be strictly complied with.
- All installation and maintenance operations must comply with design requirements of this product and national and local security operation requirements. Rule-breaking operations are prohibited.

2 PRECAUTIONS FOR THE USE OF REFRIGERANTS

The Ultra Heat GMV serial unit is a refrigerating system of R410A working substances. Pay attention to the following points:

▲WARNING

- The refrigerating system of R410A working substances has a higher working pressure than that of R22 working substances. The working pressure of the former is 1.6 times than that of the latter.
- The refrigerating system of R410A working substances uses thicker-walled copper tubes than that of R22 working substances. Adopt copper tubes with appropriate wall thickness.
- R410A working substances are azeotropic mixture working substances. Refrigerants must be appended in the form of liquid.

3 FUNCTION SETTINGS OF ODUS

Function application of ODUs consists of function DIP switch settings and function button settings, including special engineering requirements.

3.1 System Function DIP Switch Settings

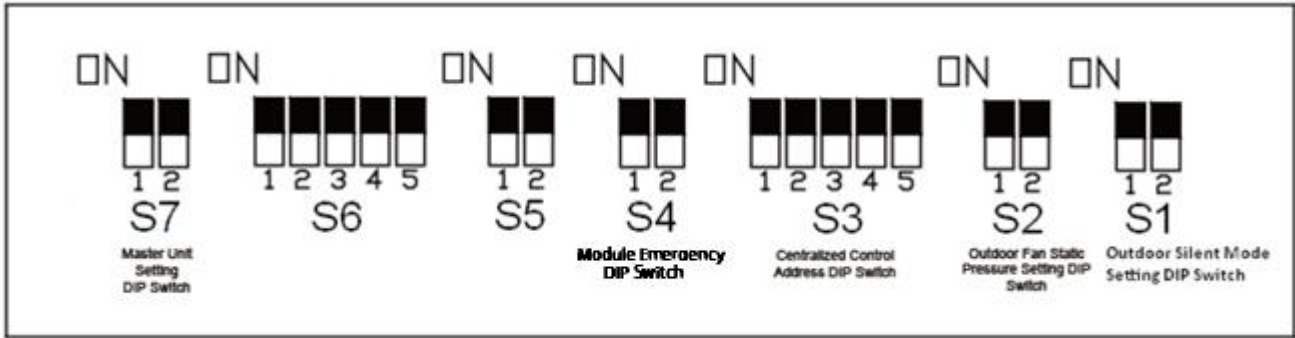

DIP Switch	Name	Meaning	Factory Settings	Remark
S1	Outdoor silent mode setting DIP Switch	Sets the noise grades of unit when necessary, especially for hospital.	00	This DIP switch is used to set noise grades at the place needing low noise.
S2	Outdoor fan static pressure setting DIP switch	Sets the static pressure of the fan according to the static pressure of the exhaust pipeline connected with the engineering unit, to guarantee normal operation of the unit.	00	This DIP switch should be set based on actual engineering conditions, neither over-large nor over-small. It is unnecessary to change the factory settings in outdoor scenarios.
S3	Centralized control address DIP switch	Defines and differentiates addresses of different systems in the case of centralized control by multiple systems.	00000	The address DIP switch is used only when centralized control is required. Otherwise, the factory settings are used without being changed. The address DIP switch is valid only when it is set on the master unit.
S4	Module emergency DIP switch	Provides after sales emergency setting for module.	00	It is better not to use the emergency function. Repair malfunctions at the first time when an exception occurs.
S5	Reserved DIP switch	---	00	---
S6	Reserved DIP switch	---	00	---
S7	Master unit setting DIP switch	Defines the master unit.	00	A master unit must be set, and only one master unit can be set in each refrigerating system. This DIP switch is mandatory. The default factory setting is the master unit status.

▲ CAUTION

- On the master module, the S3 and S7 DIP switch must be set again, and other DIP switches retain the factory settings without special requirements.
- Function DIP switch must be set only when ODUs are powered off, then the settings are valid after ODUs are powered on.
- If above DIP switch setting is incorrect, unit will work abnormally and compressor may even be damaged.

3.1.1 Outdoor silent mode setting DIP switch (S1)

The outdoor silent mode setting DIP switch (S1) is used to set noise grades at the place needing low noise, such as hospital, hotel at night, no matter in the daytime or nighttime. The silent modes of unit include standard mode, low noise mode, medium noise mode, superlow noise mode. The setting methods are as follows:

Outdoor Silent Mode Setting DIP Switch (S1)		
DIP1	DIP2	Noise Range
0	0	Standard mode
1	0	Low noise mode
0	1	medium noise mode
1	1	superlow noise mode

The default factory setting is "00".

On the DIP switch, "ON" indicates "0" status and the opposite direction indicates "1" status.

Note that the DIP switch should be independently set on each module.

▲ CAUTION

- After silent mode is set, unit's cooling and heating capacity will be lowered correspondingly. Please be noted.

3.1.2 Outdoor fan static pressure setting DIP switch (S2)

The outdoor fan static pressure setting DIP switch (S2) is used in special scenarios such as the unit installation equipment room. In scenarios where air ducts are required to be connected, zero static pressure (0 Pa), low static pressure (30 Pa), medium static pressure (50 Pa), and high static pressure (82 Pa) can be set according to the design of air ducts. The setting methods are as follows:

Outdoor Fan Static Pressure Setting DIP Switch (S2)		
DIP1	DIP2	Static Pressure Range
0	0	0 Pa/0in.W.G.
1	0	30 Pa/0.12in.W.G.
0	1	50 Pa/0.2in.W.G.
1	1	82 Pa/0.328in.W.G.

The default factory setting is "00".

On the DIP switch, "ON" indicates "0" status and the opposite direction indicates "1" status.

Note that the DIP switch should be independently set on each module.

3.1.3 Centralized control address DIP switch (S3)

The centralized control address DIP switch (S3) indicates the centralized control address required when different refrigerating systems are controlled in a centralized manner. The default factory setting is

"00000".

If it is not required to use centralized control between multiple refrigerating systems, this DIP switch can retain the factory settings without being changed.

If it is required to use centralized control between multiple refrigerating systems, set the DIP switch according to the following methods:

(1) The DIP switch must be set on the master unit. Otherwise, the setting is invalid.

(2) On the same refrigerating system, the centralized control address DIP switch (S3) on a non-master unit is invalid, and it is unnecessary to change the settings.

(3) The centralized control address DIP switch (S3) on the master unit of a refrigerating system must be set to "0000X", and this system is the master system.

(4) The centralized control address DIP switch (S3) on the master unit of other refrigerating systems must be set as follows:

Centralized Control Address DIP Switch (S3)					Address No.
DIP1	DIP2	DIP3	DIP4	DIP5	
0	0	0	0	0	1
1	0	0	0	0	2
0	1	0	0	0	3
1	1	0	0	0	4
0	0	1	0	0	5
1	0	1	0	0	6
0	1	1	0	0	7
1	1	1	0	0	8
0	0	0	1	0	9
1	0	0	1	0	10
0	1	0	1	0	11
1	1	0	1	0	12
0	0	1	1	0	13
1	0	1	1	0	14
0	1	1	1	0	15
1	1	1	1	0	16

(5) On the DIP switch, "ON" indicates "0" status and the opposite direction indicates "1" status.

(6) The centralized control address DIP switch (S3) cannot be the same between different refrigerating systems. Otherwise, address conflicts may occur and the unit cannot run properly.

3.1.4 Module emergency DIP switch (S4)

Module emergency DIP switch (S4) is used for after sales emergency settings when an exception occurs. It can shield the operation of the abnormal ODU module in a short time and guarantee the emergency operation of other ODU modules.

When it is required to shield the abnormal ODU module, set the DIP switch according to the following methods:

Module Emergency Setting DIP Switch (S4)		
DIP1	DIP2	Remark
0	0	Not shielding the operation of the abnormal module
1	0	Shielding the operation of the abnormal module
0	1	Shielding the operation of the abnormal module
1	1	Shielding the operation of the abnormal module

Precautions:

- ① When the DIP switch setting is not covered in the above scope, a DIP switch setting exception fault may occur.
- ② only one module can be set to emergency operation mode in each refrigerating system.
- ③ The module emergency operation mode is valid only in a system with more than two modules connection in parallel.
- ④ Settings must be performed in power-off status.
- ⑤ The default factory setting is "00" master unit status.
- ⑥ The system cannot continually run for more than 48 hours in module emergency operation status. Once 48 hours are exceeded, the entire unit will be forcibly stopped and the limited operation code "Ad" is displayed on the IDU.

3.1.5 Reserved function DIP switch (S5, S6)

S5, S6 are the reserved function DIP switch and meaningless currently.

3.1.6 Master unit setting DIP switch (S7)

The master unit setting DIP switch (S7) defines module management of a system. A master unit must be set, and only one master unit can be set in each refrigerating system (in power-off status). The setting methods are as follows:

Master Unit Setting DIP Switch (S7)		
DIP1	DIP2	Remark
0	0	Master unit
1	0	Slave unit

Upon factory departure, all modules are in "00" master unit status by default. When multiple modules are connected in parallel, only one module retains the master unit status and other modules are set to slave status. When a module is independently used, it uses the factory settings.

Precautions:

- ① When the DIP switch setting is not covered in the above scope, a DIP switch setting exception fault may occur.
- ② A module must be set to master unit status, and only one module can be set to master unit status in each refrigerating system. Other modules are set to slave module status.
- ③ Settings must be performed in power-off status.
- ④ The default factory setting is "00" master unit status.
- ⑤ Master module must be set correctly; otherwise units cannot be started up.

3.1.7 DIP switch example

(1) Explanation of DIP switch positions

On the DIP switch, "ON" indicates "0" status and the opposite direction indicates "1" status.

The position of white lever indicates the position to be set to.

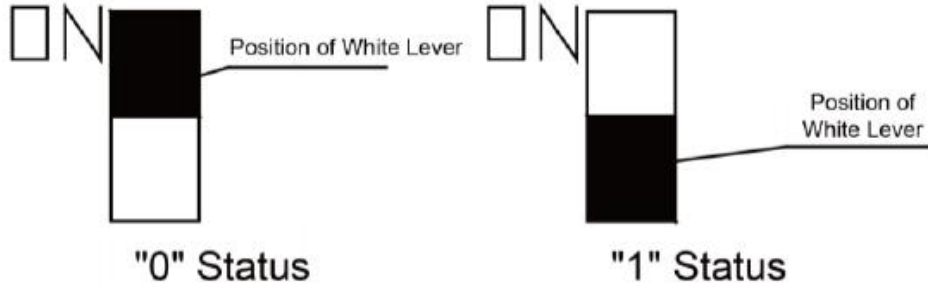

(2) Example

The following takes outdoor fan static pressure settings as an example. Set 30Pa to master unit. The settings are as follows:

Master unit	<p>S7</p>
30Pa	<p>S2</p>

Note:

- ① System function settings and query must be performed after commissioning of the entire unit.
- ② System function settings and query can be used no matter whether the entire unit runs.

3.2 System Function Button Operations

3.2.1 Introduction to function buttons

▲WARNING

- When function buttons are used to set functions for outdoor unit, the cover of electric box and panel must be assembled well. Setting can only be done through the maintenance window. Otherwise, electric shock may occur.

The main board AP7 of the ODU consists of six function buttons:



Function Button Name and Meaning		
Button	Code	Function Meaning
SW1	FUNCTION	Indicates the function button, used for function settings.
SW2	+	Indicates the upward selection button.
SW3	-	Indicates the downward selection button.
SW4	ENTER	Indicates the confirmation button.
SW5	BACK	Indicates the return button, used to return to the upper-level menu.
SW6		Reserved function and meaningless currently.

3.2.2 Introduction to functions

Function Code	Function Name	Function Meaning	Remark
Ft	Test run mode	Used for running before factory, enable ODU controller and parts to work fluently.	Control (CU) function can be set as ON or OFF according to actual situation.
A8	Aftersales vacuuming mode	Automatically enables all electronic expansion valves and electromagnetic valves during maintenance to guarantee vacuum processing in all pipelines.	
A2	Refrigerant recovery operation	Fully or partially recovers refrigerants in a faulty module or IDU pipeline according to the system pressure after automatic startup during maintenance.	
A3	Forcible defrosting operation	Forcibly enables ODU defrosting operation.	
n5	Indoor unit project number offset	Prevents IDU project number conflicts when different refrigerating systems are controlled in a centralized manner.	
A6	Unit cooling/heating function	Sets the unit to cooling/heating, single-cooling, single-heating, or air supply mode for centralized management.	Control (CU) function The factory setting is cooling/heating.
NH	Suction temperature	Displays the value of suction temperature.	Display (DI) function is to display the value of ODU parameter.
NP	Discharge temperature	Displays the value of discharge temperature.	
NW	Environment temperature	Displays the value of environment temperature.	
PL	Low pressure	Displays the value of low pressure.	
PM	Middle pressure	Displays the value of middle pressure.	
PH	High pressure	Displays the value of high pressure.	
N1	Online ODU quantity	Displays the number of online ODUs.	
N9	Online IDU quantity	Displays the number of online IDUs.	



- If above function settings are incorrect, unit will run abnormal and compressor may even be damaged.

3.3 Function Setting Operations

Step 1: Open the commissioning window of the master unit panel.

Step 2: Power on the entire unit.

Step 3: Press "SW1" on the master unit at least 2 seconds to enter the to-be-selected status of function settings. By default, the master unit is displayed as follows:

LED1		LED2		LED3	
Function Code	Display Mode	Confirmation	Display Mode	Current Data	Display Mode
CU	Blinking	/	/	/	/

Press "SW1" on the master unit again, the master unit is displayed as follows:

LED1		LED2		LED3	
Function Code	Display Mode	Confirmation	Display Mode	Current Data	Display Mode
DI	Blinking	/	/	/	/

Step 4: When "CU" function displays, press "SW4" on the master unit, then the master unit is displayed as follows:

LED1		LED2		LED3	
Function Code	Display Mode	Confirmation	Display Mode	Current Data	Display Mode
Ft	Blinking	/	/	OF	On

Then users can select corresponding functions by pressing "SW1" on the master unit, including:

LED1		LED2		LED3	
Function Code	Display Mode	Confirmation	Display Mode	Current Data	Display Mode
Ft	Blinking	/	/	OF	On
A8	Blinking	/	/	OF	On
A2	Blinking	/	/	OF	On
A3	Blinking	/	/	OF	On
n5	Blinking	/	/	OF	On
A6	Blinking	/	/	nC	On

Step 5: after selecting the functions to be set, press "SW4" to confirm entering function settings. The master unit is displayed as follows:

LED1		LED2		LED3	
Function Code	Display Mode	Confirmation	Display Mode	Current Data	Display Mode
Ft	On	/	/	OF	Blinking
A8	On	/	/	OF	Blinking
A2	On	/	/	OF	Blinking
A3	On	/	/	OF	Blinking
n5	On	/	/	OF	On
A6	On	/	/	nC	On

For example, if A8 function is selected in step 5, then press "SW2 (+)" or "SW3 (-)" to set data (LED3).

The master unit is displayed as follows:

LED1		LED2		LED3	
Function Code	Display Mode	Confirmation	Display Mode	Current Data	Display Mode
A8	On	/	/	OF	Blinking
A8	On	/	/	On	Blinking

Next, if "On" data is selected, then press "SW4" to confirm it. The master unit is displayed as follows:

LED1		LED2		LED3	
Function Code	Display Mode	Confirmation	Display Mode	Current Data	Display Mode
A8	On	=	On	On	On

Note: other CU function's setting way is the same with "A8". "/" means nothing displayed.

On the master unit, press "SW5" to return to the upper level if there are two levels of menu. And press "SW5" long to cancel the setting function status.

Step 6: When "DI" function displays, press "SW4" on the master unit, then the master unit is displayed as follows:

LED1		LED2		LED3	
Function Code	Display Mode	Confirmation	Display Mode	Current Data	Display Mode
NH	Blinking	/	/	Parameter value	On

Then users can select corresponding functions by pressing "SW1" on the master unit, including:

LED1		LED2		LED3	
Function Code	Display Mode	Confirmation	Display Mode	Current Data	Display Mode
NH	Blinking	/	/	Parameter value	On
NP	Blinking	/	/	Parameter value	On
NW	Blinking	/	/	Parameter value	On
PL	Blinking	/	/	Parameter value	On
PM	Blinking	/	/	Parameter value	On
PH	Blinking	/	/	Parameter value	On
N1	Blinking	/	/	Parameter value	On
N9	Blinking	/	/	Parameter value	On

LED3 displays the parameter value. By default, the ODU temperature values unit are °C, and pressure values unit are 0.01MPa.

For example:

Parameter Code	Parameter Name	Unit	Remark
NH	Suction temperature	°C	If LED3 shows 12, it means suction temperature is 12°C.
NP	Discharge temperature	°C	If LED2 shows 1 and LED3 shows 04, it means discharge temperature is 104°C.
NW	Environment temperature	°C	If LED2 shows - and LED3 shows 10, it means environment temperature is -10°C.
PL	Low pressure	0.01MPa	If LED3 shows 95, it means low pressure is 0.95MPa.
PM	Middle pressure	0.01MPa	

PH	High pressure	0.01MPa	If LED2 shows 2 and LED3 shows 80, it means high pressure is 2.80MPa.
N1	Online ODU quantity	/	
N9	Online IDU quantity	/	

NOTE: On the master unit, press "SW5" to return to the upper level if there are two levels of menu. And press "SW5" long to cancel the setting function status.

If no button operations are performed on the master unit for one minute, the function setting automatically quits and the unit do not restore the current status.

3.4 Basic Operations for Engineering Commissioning

3.4.1 Basic operations

Basic Operations	Operation Method	Remark
Starting engineering commissioning	Press and hold "SW4" on the master unit for more than six seconds.	—
Quitting engineering commissioning	In engineering commissioning status, press and hold "SW5" for more than six seconds on the master unit to quit commissioning.	—
Pause-continue engineering commissioning	After the step 5 of engineering commissioning status, press "SW5" on the master unit to return to the previous commissioning phase of the current commissioning phase, and follow steps.	This function is valid after step 5. For example, if receiving a pause-continue engineering commissioning signal during the process of step 7, the system will restore the completion phase of step 6.

3.4.2 Restoring factory settings

Restoring Factory Settings	Remark
Restoring setting 1 (A1)	All factory settings of the ODU are restored and the unit waits for re-commissioning.

Step 1: Open the commissioning window of the master unit panel.

Step 2: Power on the entire unit.

Step 3: Press "SW4" on the master unit at least 6 seconds to enter the to-be-selected status of function settings. By default, the master unit is displayed as follows:

LED1		LED2		LED3	
Function Code	Display Mode	Confirmation	Display Mode	Current Data	Display Mode
A0	Blinking	/	/	/	/

Press "SW1" on the master unit to select corresponding functions, including:

LED1		LED2		LED3	
Function Code	Display Mode	Confirmation	Display Mode	Current Data	Display Mode
A0	Blinking	/	/	/	/
A1	Blinking	/	/	/	/

Step 4: after selecting the functions to be set, press "SW4" to confirm entering function settings. The master unit is displayed as follows:

LED1		LED2		LED3	
Function Code	Display Mode	Confirmation	Display Mode	Current Data	Display Mode
A1	On	/	/	OF	Blinking

For example, if A1 function is selected in step 5, then press "SW2 (+)" or "SW3 (-)" to set data (LED3).

The master unit is displayed as follows:

LED1		LED2		LED3	
Function Code	Display Mode	Confirmation	Display Mode	Current Data	Display Mode
A1	On	/	/	OF	Blinking
A1	On	/	/	On	Blinking

Next, if "On" data is selected, then press "SW4" to confirm it. The master unit is displayed as follows:

LED1		LED2		LED3	
Function Code	Display Mode	Confirmation	Display Mode	Current Data	Display Mode
A1	On	=	On	On	On

Note: A2 function's setting way is the same with "A1". "/" means nothing displayed.

▲ CAUTION

- If above function settings are incorrect, unit will run abnormal and compressor may even be damaged.

PART 2 COMMISSIONING PROCESS

NOTICE!

- ① It is forbidden to directly connect the compressor with power supply and forcibly power it on during commissioning and maintenance.
- ② Engineering commissioning operations must be performed on the Ultra Heat GMV serial unit. Otherwise, the unit cannot properly run.
- ③ Before commissioning is completed, the main board of ODU displays "A0" and that of IDU displays "A0".
- ④ A module must be set to master module and only one can be set during commissioning.
- ⑤ An IDU must be set to master IDU and only one can be set during commissioning for heat pump; And for heat recovery VRF, there is no need to set master IDU.
- ⑥ Other functions can use the factory settings if there are not special engineering requirements.

1 NECESSITY OF VRF ENGINEERING COMMISSIONING

Different from ordinary air conditioning units, the VRF system raises high design requirements and easily incurs operation-affected factors such as impurities and water during engineering installation. Due to the requirements on engineering design/installation complexity and high-precise system control, commissioning is mandatory after engineering installation. Only a qualified unit can be delivered for use.

2 REQUIRED FILES AND TOOLS FOR ENGINEERING DEBUGGING

2.1 Required Tools for Engineering Commissioning

Inner hexagon spanner	Digital thermometer
Shifting spanner	Noise meter
Cross screwdriver	Clamp meter
Straight screwdriver	Digital multimeter
Vacuum pump	Electricity meter
Electronic balance	Timer
System high and low pressure gauges for corresponding refrigerants	Step ladder
Wind-speed transmitter	...

The Ultra Heat GMV provides two commissioning methods. One is to perform commissioning by pressing buttons on the main board of ODU. The other is to perform commissioning on a PC through professional software. Parameters of the ODU and IDU can be simultaneously displayed with the second method. (For details about these methods, refer to respective instructions.)

2.2 Commissioning Files

The following commissioning files are required to record installation and commissioning of units: pre-commissioning scheme determination meeting minutes, commissioning personnel record tables, commissioning system appearance check record tables, commissioning data record tables, and

commissioning reports. See attached tables for file formats.

3 ENGINEERING COMMISSIONING PROCEDURES

3.1 Pre-commissioning Preparations

3.1.1 Overall commissioning plan

Before commissioning, the person-in-charge should learn about the overall engineering progress plan, overall workload of engineering commissioning, possible influence factors in achieving the commissioning progress, and required labors and materials.

3.1.2 Composition of commissioning members

Commissioning members comprise after sales commissioning personnel and installation personnel.

All commissioning participants must take part in professional training courses before unit commissioning. All participants can be grouped as required and each group should include at least professional commissioning personnel and assistants.

3.1.3 Preparations of commissioning tools and instruments

- (1) Make sure that the following tools or instruments are prepared before commissioning.
- (2) Make sure that the commissioning software is correct before commissioning.
- (3) The professional after sales commissioning software provided by GREE should be used for commissioning of GREE VRF system.
- (4) Make sure that all required files and parameter records are prepared.

3.2 Pre-commissioning Check

Installation environment check covers the heat exchange environment of unit and electromagnetic radiant components. All requirements should comply with national and local electrical standards. For any installation incompliance, records should be made for providing an analysis basis during refrigerating system testing.

3.2.1 Installation appearance check

Installation appearance check covers whether pipeline installation complies with specifications, whether refrigerant pipes and condensing drainage pipes are thermal insulated, and whether

Refrigerant pipes should be tidily installed with outdoor and indoor disperse pipes leaning in the required scope. For any installation incompliance, records should be made for providing an analysis basis during refrigerating system testing.

Refrigerant pipes and condensing drainage pipes should not be exposed. If any pipe is exposed, an immediate amendment is required to avoid serious loss.

3.2.2 Refrigerating system check

- (1) Before commissioning, make sure that the stop valve of each module reaches the maximum opening degree. Check whether there is any refrigerator oil leakage around the valve. If there is, immediately check for leakage with soap bubbles or leak detectors. If confirming that leakage exists, immediately stop commissioning and solve the problem before continuing commissioning.

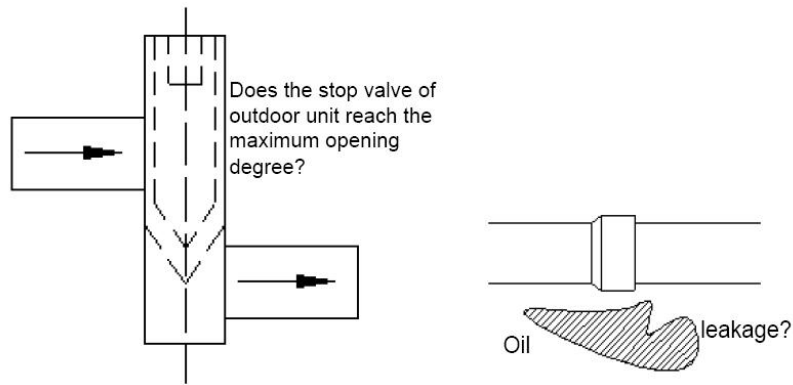

(2) Check system refrigerants before startup

Before the system is started, connect the liquid-tube valve of ODU with a high pressure gauge and the gas-tube valve of ODU with a low pressure gauge, and then read their values. In this case, high pressure and low pressure of the system should be in balance status, and the difference between the saturation temperature corresponding to the balanced pressure value and the environment temperature (the higher in outdoor and indoor temperatures is taken as environment temperature) should not be larger than 5°C K. If the difference is larger than 5°C K, it is required to check the ODU for leakage.

NOTE: Guarantee that the system has never been started before this test. Otherwise, the high pressure value will be over-higher than the environment temperature or the low pressure value will be over-lower than the environment temperature.

Example:

The outdoor environment temperature is 30°C (86 °F) and the indoor environment temperature is 28°C (82 °F). The pressure gauges connected with the system show that the high pressure value is 28°C (82 °F) and the low pressure value is 27°C (81 °F). The difference between the outdoor environment temperature and either pressure value is less than 5°C K. It indicates that the system standby pressure is normal.

3.2.3 Electrical system check

(1) Check for high electromagnetic interference, dusts, and acidic or alkaline gas in the unit environment.

1) The air conditioning unit can neither share the same power supply system with the equipment containing variable-frequency drives, nor reside near the equipment generating high electromagnetic interference. Otherwise, the air conditioning unit may fail to properly work due to interference. If this case exists, records should be made. In the case of serious influence, the air conditioning unit must be relocated or relevant measures must be taken.

2) Prevent acidic or alkaline gas/liquid from rusting cables of the air conditioning unit.

(2) Check the installation appearance of power cables.

Check whether power cables of indoor and ODUs are installed according to vendor requirements and whether cable connectors are reliably connected. Except the connection part of patch panels, wire exposure is not allowed on any connection part of power cables.

(3) Check the power capacity required for the unit.

The air conditioning unit works at a current much larger than the rated current (the working current changes in a large scope in different conditions). The power grid provides unstable voltages and the line power factor decreases. Therefore, the power capacity should not be less than the maximum power of the unit.

(4) Check air switches and fuse links for their models and using methods.

1) Commercial air conditioning units must be installed with independent air switches, fuse links, and similar protectors. Reasonable models and using methods should be selected for air switches and fuse links.

Remarks:

a. Air switches work for overload and short-circuit protection. Air switches provide a less breaking current than fuse links and air switches react more slowly than fuse links. The advantage of air switches is that they can be manually reset after a protection action.

b. Fuse links only work for short-circuit protection. They provide a large breaking current and act slowly. However, fuses must be replaced after a protection action.

2) Select air switch models according to the power cable diameter and air switch specifications. In general, the rated current of air switches should be larger than or equal to the load current calculated based on the line, and less than or equal to the persistent current rating allowed by the conductor.

(5) Check components in the electric box.

In the case of unit power-off, visually check whether any component in the electric box drops during transportation. Then, check whether any component or cable is loose or drops by hand. For a large-scale unit, power cable terminals of the patch panel and cable terminals connected with connectors must be tightened with a sleeve spanner or screwdriver, and tightened once more after two months of normal operation. Auxiliary contacts of AC connectors cannot be removed because they have been debugged upon factory departure.

(6) Check the input power.

1) Power consistency check: Measure the power supply to be connected with the air conditioning unit for its voltage, frequency, three-phase voltage unbalance factor, and frequency offset. Specifications of the power supply should be consistent with power specifications displayed on the unit nameplate. The fluctuation range of voltage should be within $\pm 10\%$.

2) Phase sequence check:

a. After powering on the unit, measure the voltage value between every two of L1, L2, and L3 bits. In general, the voltage between every two of L1, L2, and L3 bits should approach 208~230 V. If the measurement result does not match the above-mentioned normal value, check whether the external power cable is inversely connected.

b. Observe the code displayed on the digital LED of the main board AP7. If the fault code "U3" is displayed, it indicates that the phase sequence of the external power cable connected with the air conditioning unit is incorrect. Power off the unit and exchange any two phases among L1, L2, and L3 bits on one end of the external power cable. Power on the unit and observe the code again. The fault code

“U3” should disappear.

3.2.4 Communication system check

(1) The following communication contents must be checked again before commissioning:

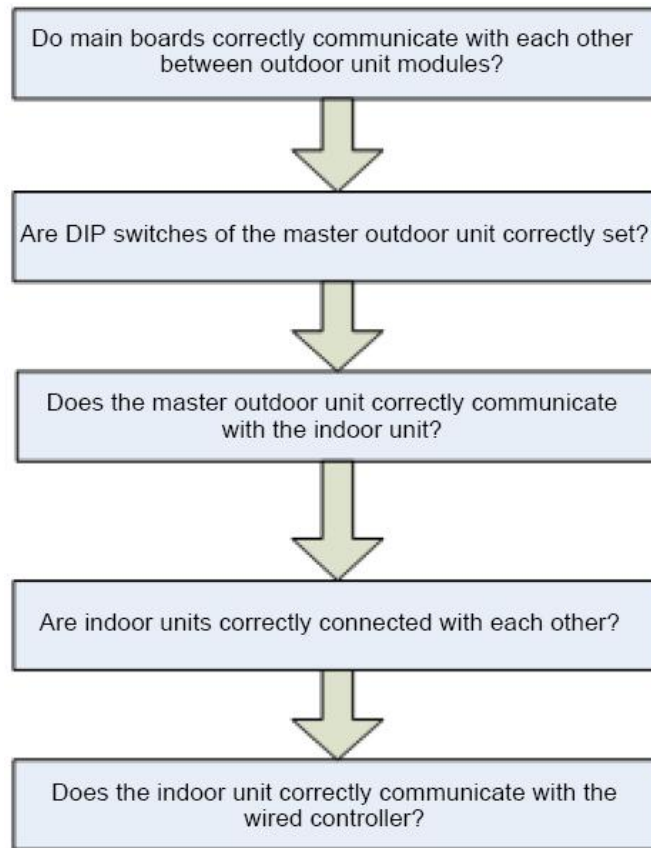

(2) Communication cables cannot be laid out in the same trough as power cables. Communication cables should be independently laid out in hard fire-resistant PVC tubes. The parallel spacing between communication cables and strong electric wires should be larger than 20 cm.

3.2.5 Spot check

Spot Check for Ultra Heat GMV Commissioning		
SN	Spot Check Item	Qualified
1	Is the engineering design diagram complete?	
2	Does the construction comply with the design diagram?	
3	Is the rated capacity of the IDU/ODU of a single refrigerating system within 50%-135%?	
4	Is the number of connected IDUs in a single refrigerating system within 80?	
5	Is the access capacity of a fresh-air unit within 30%?	
6	Does the difference of level between IDUs and ODUs comply with unit design requirements?	
7	Does the difference of level between IDUs comply with unit design requirements?	
8	Are long pipes of IDUs and ODUs less than or equal to 165 m (541ft) ?	
9	Is the total length of pipes less than 1000 m (3280ft) ?	
10	Is the spacing between the ODU and the first disperse pipe larger than 90 m (295ft) ? If yes, is the corresponding pipe diameter increased?	
11	Is the spacing between the IDU and the nearest disperse pipe larger than 10 m (33ft) ? If yes, is the corresponding pipe diameter increased?	

12	Does the wall thickness of copper tubes meet design requirements?	
13	Are disperse pipes horizontal or vertical?	
14	Does the diameter of cables connected with IDUs and ODU's comply with unit design requirements?	
15	Do the circuit breaker and leakage switch comply with unit design requirements?	
16	Is the spacing between the power cable and the TV set larger than 1 m?	
17	Do communication cable materials comply with unit design requirements?	
18	Are all communication cables of IDUs and ODU's serially connected?	
19	Is the last-communicating IDU installed with a communication-matched resistance?	
20	What is the load of the selected IDU model?	
21	Is the foundation of ODU firm? Do shock absorption and water drainage comply with requirements?	
22	Are basic modules installed on the same horizontal line?	
23	Does the drainage pipe of IDU retain a 1/100 ratio of slope?	
24	Is the drainage of IDU smooth?	
25	Does a U-shaped trap exist in the drainage pipe of IDU?	
26	Are the air outlet and air return vent of IDU connected with soft connectors? Is a plenum chamber installed for air return?	
27	Is the water pipe of IDU installed with an air exhaust vent?	
28	Is "MASTER" stuck to the wired controller or panel of the master IDU?	
29	Does appending refrigerants to the system comply with requirements?	
30	Does the ODU run with static pressure? Has a static pressure value been set?	
31	Has the ODU been preheated for more than eight hours before commissioning?	

3.3 Commissioning Operation

3.3.1 Precautions

(1) Before starting commissioning, make sure that the unit compressor has been preheated for more than eight hours and check whether preheating is normal by touching. Commissioning can be started only when preheating is normal. Otherwise, the compressor may be damaged.

Commissioning must be performed or guided by professional personnel.

▲ CAUTION

- Before starting commissioning, the outdoor unit must be power-on for more than 8 hours. Otherwise, compressor may be damaged.
- During daily operation, please keep the outdoor unit power-on at any time.
- If unit is power-off for more than 24 hours, it must be preheated for at least 8 hours before operation.

(2) When unit commissioning is started, the system automatically selects an operation mode according to the environment temperature:

Cooling mode when the outdoor environment temperature is higher than 20°C (68°F) .

Heating mode when the outdoor environment temperature is lower than 20°C (68°F) .

(3) Before starting commissioning, make sure again that stop valves of all basic modules of the ODU have been completely opened.

(4) During commissioning, the front panel of ODU must be completely covered. Otherwise, commissioning accuracy may be affected (as shown in the following figure).

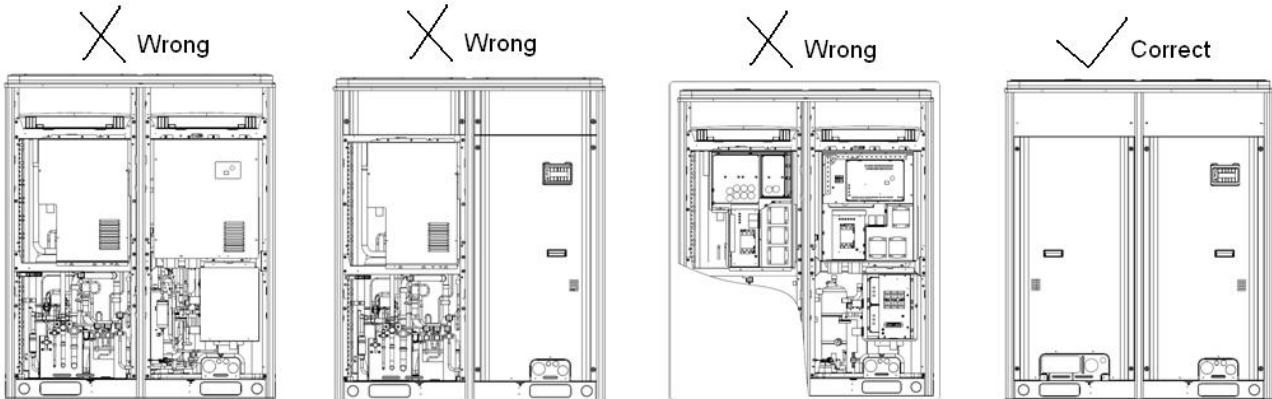

(5) Before commissioning, make sure that appending refrigerants to pipes has finished completely or for more than 70%.

(6) The following table describes progress display of each phase during commissioning:

Description of each stage of debugging progress							
Progress	Debugging code		Progress code		Status code		Meaning
	LED1		LED2		LED3		
	Code	Display status	Code	Display status	Code	Display status	
01_ Set master unit malfunction	A0	Light					System is not debugged.
	CC	Light					Master unit hasn't been set, please set it.
	CF	Light					Master unit is two or more than two. Please reset.
	CJ	Light					Address DIP switch code of system is shocking.
	db	Light	01	Light	oC	Light	Master unit has been set successfully. Next step will start automatically.
02_Allocate addresses	db	Light	02	Light	oC	Light	Address allocation is finished. Next step will start automatically.
03_Confirm the quantity of modules	db	Light	03	Blink	01~03	Blink	LED3 displays the quantity of module. In this case, please confirm if the quantity is correct manually.
	db	Light	03	Light	oC	Light	System has confirmed the quantity of module. Next step will start automatically.
04_Confirm the quantity of IDUs	db	Light	04	Blink	01~60	Blink	LED3 displays the quantity of IDU. In this case, please confirm if the quantity is correct manually.
	db	Light	04	Light	oC	Light	System has confirmed the quantity of IDU. Next step will start automatically.

05_Internal communication detection	C2	Light					Communication between master ODU and inverter compressor driver has error.
	C0	Light					Communication between master ODU and IDUs has error.
	db	Light	05	Light	oC	Light	System detection is done. Next step will start automatically.
06_Detect outdoor components	Error code	Light					System detects that outdoor components have error.
	db	Light	06	Light	oC	Light	System detects no error on outdoor components. Next step will start automatically.
07_Detect indoor components	XXXX/ Error code	Light					System detects error on indoor components. XXXX means the project code of IDU with error. 3s later, related error code will be displayed.
	db	Light	07	Light	oC	Light	System detects no error on indoor components. Next step will start automatically.
08_Confirm preheated compressor	db	Light	08	Light	on	Light	LED3 displays the on-off state of ODU valves connecting with IDU. In this case, please confirm if the ODU valves are open manually.
	db	Light	08	Light	U0/ Preheat time	Blink	U0 means preheat time for compressor is less than 8 hours.
	db	Light	08	Light	oC	Light	Compressor has been preheated for 8 hours. Next step will start automatically.
09_Refrigerant judgments before startup	U4	Light					System is lack of refrigerant.
	db	Light	09	Light	oC	Light	Refrigerant is normal. Next step will start automatically.
10_	---	---	---	---	---	---	No meaning.
11_	---	---	---	---	---	---	No meaning.
12_Confirm debugging startup	db	Light	12	Light	AE	Blink	Ready for units to start debugging.
	db	Light	12	Light	oC	Light	The unit starts up in the status of manual calculation of refrigerant charging amount.
13_	---	---	---	---	---	---	No meaning.
14_	---	---	---	---	---	---	No meaning.
15_Cooling debugging	db	Light	15	Light	UC	Light	Debugging for cooling mode. (Debugging operation mode, the system will select automatically with no need of manual setting).
	Error code	Light					Malfunction occurs when debugging for cooling mode.
16_Heating debugging	db	Light	16	Light	UH	Light	Debugging for heating mode. (Debugging operation mode, the system will select automatically with no need of manual setting).
	Error code	Light					Malfunction occurs when debugging for heating mode.

3.3.2 Commissioning operations mode

The Ultra Heat GMV provides two commissioning methods. One is direct operation on main board of outdoor units while the other is PC operation via special software. In PC software debugging, indoor/outdoor parameters can be displayed and historical data can be recorded and inquired. (Operation details can be found in relevant instruction manuals)

3.3.2.1 Commissioning through Operation on Main Board of ODU

In this debugging mode, following debugging functions are included on the main board:

Step 1: front panel of the outdoor units must be fully closed. Open the debugging window of each basic module;

Step 2: disconnect power for outdoor units. According to design requirements of external static pressure, set up corresponding static pressure mode for the units. Setting methods can be seen in Outdoor Fan Static Pressure Setup S2 of Technical service manual; Silent mode setting method can also be seen in silent mode setting S1 of Technical service manual;

Step 3: Disconnect power for outdoor units and set one module as a master unit. Setting methods can be seen in Master Unit Setup S7 of Technical service manual (Set master unit S7 as “00”; Set slave unit S7 as “10”).

Step 4: Connect power for all indoor units. Make sure all IDUs are power on. Then all outdoor modules will display “A0”.

Step 5: Find the module with “00” of S7 which is the master module. The main board shows:

Debugging code		Progress code		Status code	
LED1		LED2		LED3	
Code	Display status	code	Display status	Code	Display status
A0	Light			0	Light

Hold SW4 button on the master module for at least 6s to enable debugging. Then the main board shows:

Debugging code		Progress code		Status code	
LED1		LED2		LED3	
Code	Display status	code	Display status	Code	Display status
A0	Blink				

Press SW4 confirmation button on the master unit to confirm it. Unit will start debugging.

Step 6: Wait. Unit will then start progress 01.

If no error is detected, system will display as below and then start next progress.

—	Debugging code		Progress code		Status code	
progress	LED1		LED2		LED3	
	Code	Display status	code	Display status	Code	Display status
01_Set up master unit	db	Light	01	Light	oC	Light

If unit have some errors, progress 01 will show the following errors:

—	Debugging Code	Progress Code	Status Code	Meaning
Progress	LED1	LED2	LED3	

	Code	Display status	Code	Display status	Code	Display status	
01_Set up master unit	CC	Light					System doesn't have master unit. Reset master unit.
	CF	Light					More than 2 master units are set. Reset master unit.
	CJ	Light					Address DIP switch code of system is shocking.

According to the above errors, reset the master unit (Set master unit S7 as "00"; Set slave unit S7 as "10"), then start debugging again.

Step 7: Progress 02 is allocating addresses. If allocating addresses is done, then main board shows:

—	Debugging code		Progress code		Status code	
Progress	LED1		LED2		LED3	
	Code	Display status	Code	Display status	Code	Display status
02_Allocate addresses	db	Light	02	Light	oC	Light

Step 8: In progress 03, the quantity of modules needs to be confirmed manually. Main board will display:

—	Debugging code		Progress code		Status code	
Progress	LED1		LED2		LED3	
	Code	Display status	Code	Display status	Code	Display status
03_Confirm the quantity of modules	db	Light	03	Light	Quantity of modules	Blink

If the quantity displayed is the same with actual quantity, then press SW4 confirmation button on the master unit to confirm it. Unit will start next progress:

—	Debugging code		Progress code		Status code	
Progress	LED1		LED2		LED3	
	Code	Display status	Code	Display status	Code	Display status
03_Confirm the quantity of modules	db	Light	03	Light	oC	Light

If the quantity displayed is different from actual quantity, then disconnect power and check whether communication wire among each module is correctly connected. After the check, start debugging again.

Step 9: In progress 04, the quantity of IDUs needs to be confirmed manually. Main board will display:

—	Debugging code		Progress code		Status code	
Progress	LED1		LED2		LED3	
	Code	Display status	Code	Display status	Code	Display status
04_Confirm the quantity of IDUs	db	Light	04	Light	Quantity of connected IDUs	Blink

If the quantity displayed is the same with actual quantity, then press SW4 confirmation button on the master unit to confirm it. Unit will start next progress:

—	Debugging code		Progress code		Status code	
Progress	LED1		LED2		LED3	
	Code	Display status	Code	Display status	Code	Display status

04_Confirm the quantity of IDUs	db	Light	04	Light	oC	Light
---------------------------------	----	-------	----	-------	----	-------

Step 10: Progress 05 is internal communication detection.

If no error is detected, system will display as below and then start next progress.

—	Debugging code		Progress code		Status code	
Progress	LED1		LED2		LED3	
	Code	Display status	Code	Display status	Code	Display status
05_Internal communication detection	db	Light	05	Light	oC	Light

If error is detected, system will stay at current progress. Error has to be solved manually. Related errors are:

—	Debugging Code		Progress Code		Status Code		Meaning
Progress	LED1		LED2		LED3		
	Code	Display status	Code	Display status	Code	Display status	
05_Internal communication detection	C2	Light					Communication between master ODU and inverter compressor driver has error.
	C0	Light					Communication between master ODU and IDUs has error.

Elimination methods of above errors can be found in Troubleshooting.

Step 11: Progress 06 is “Detect outdoor components”.

If no error is detected, system will display as below and then start next progress.

—	Debugging code		Progress code		Status code	
Progress	LED1		LED2		LED3	
	Code	Display status	Code	Display status	Code	Display status
06_Detect outdoor components	db	Light	06	Light	oC	Light

If error is detected, system will stay at current progress. Error has to be solved manually. Related errors are:

—	Debugging Code		Progress Code		Status Code		Meaning
Progress	LED1		LED2		LED3		
	Code	Display status	Code	Display status	Code	Display status	
06_Detect outdoor components	Error code	Light					System detects that outdoor components have error.

Elimination methods of above errors can be found in Troubleshooting.

Step 12: Progress 07 is “Detect indoor components”.

If no error is detected, system will display as below and then start next progress.

—	Debugging code		Progress code		Status code	
Progress	LED1		LED2		LED3	
	Code	Display status	Code	Display status	Code	Display status
07_Detect indoor components	db	Light	07	Light	oC	Light

If error is detected, system will stay at current progress. Error has to be solved manually. Related errors are:

Progress	Debugging Code		Progress Code		Status Code		Meaning
	LED1		LED2		LED3		
	Code	Display status	Code	Display status	Code	Display status	
07_Detect indoor components	XXXX/ Error code	Light					System detects error on indoor components. XXXX means the project code of IDU with error. 3s later, related error code will be displayed.

Elimination methods of above errors can be found in Troubleshooting.

Step 13: Progress 08 is “Confirm preheated compressor”.

At first, make sure that the ODU valves connecting with IDU are opening. Main board will display:

Progress	Debugging code		Progress code		Status code	
	LED1		LED2		LED3	
	Code	Display status	Code	Display status	Code	Display status
08_Confirm preheated compressor	db	Light	08	Light	on	Light

If the ODU valves connecting with IDU have been opened manually, then press SW4 confirmation button on the master unit to confirm it.

If ODU compressors have been preheated for more than 8h, system will display as below and start next progress.

progress	Debugging code		Progress code		Status code	
	LED1		LED2		LED3	
	Code	Display status	code	Display status	Code	Display status
08_Confirm preheated compressor	db	Light	08	Light	oC	Light

If less than 8h of preheat time is detected, system will give error alarm and display as below. Then press SW4 confirmation button and SW2 button at the same time to skip the wait time and start next progress. But this will cause force start of the compressor, which may damage the compressor.

Progress	Debugging code		Progress code		Status code	
	LED1		LED2		LED3	
	Code	Display status	Code	Display status	Code	Display status
08_Confirm preheated compressor	db	Light	08	Light	U0/ Preheat time	Blink

Step 14: Progress 09 is “Refrigerant judgments before startup”.

If the refrigerant quantity inside the system meets the requirement of operation startup, system will display as below and start next progress.

progress	Debugging code		Progress code		Status code	
	LED1		LED2		LED3	
	Code	Display status	code	Display status	Code	Display status
09_Refrigerant judgments before startup	db	Light	09	Light	oC	Light

If there's no or not enough refrigerant in the system to meet the requirement of operation startup, system will display U4 "refrigerant shortage protection" and fails to start next progress. Then check if there's any leakage or add refrigerant inside until error eliminates.

—	Debugging code		Progress code		Status code	
progress	LED1		LED2		LED3	
	Code	Display status	code	Display status	Code	Display status
09_Refrigerant judgments before startup	U4	Light				

Step 15: Progress 12 is "Confirm debugging startup".

In order to make sure all preparation work is done before startup, this step is designed for user to confirm the startup again. Operate as below:

If master unit displays as below, system is waiting for confirmation signal.

—	Debugging code		Progress code		Status code	
progress	LED1		LED2		LED3	
	Code	Display status	code	Display status	Code	Display status
12_Confirm debugging startup	db	Light	12	Blink	AE	Light

If it's confirmed, press SW4 confirmation button. Then unit will display as below and start next progress.

—	Debugging code		Progress code		Status code	
progress	LED1		LED2		LED3	
	Code	Display status	code	Display status	Code	Display status
12_Confirm debugging startup	db	Light	12	Light	oC	Light

Step 16: After unit is confirmed to start debugging, system select cooling/heating mode according to ambient temperature automatically.

A If cooling mode is selected, relevant display is as below:

—	Debugging code		Progress code		Status code		Meaning
progress	LED1		LED2		LED3		
	Code	Display status	code	Display status	Code	Display status	
15_Cooling debugging	db	Light	15	Light	UC	Light	Debugging is enabled in cooling mode (debugging mode, auto-selected by system).
	Error code	Light					ODU Error occurs during debugging in cooling mode.
	XXXX/ Error code	Light					System detects error in indoor error. XXXX is the project code of the faulted IDU. 3s later, error code is displayed. For example, IDU no. 100 has d5 error, then LED3 displays like this: 01 (2s later) 00 (2s later) d5, and repeat again.

B If heating mode is selected, relevant display is as below:

—	Debugging code		Progress code		Status code		Meaning
	LED1		LED2		LED3		
	Code	Display status	code	Display status	Code	Display status	
16_Heating debugging	db	Light	16	Light	UH	Light	Debugging is enabled in heating mode (debugging mode, auto-selected by system).
	Error code	Light					ODU Error occurs during debugging in heating mode.
	XXXX/ Error code	Light					System detects error in indoor pipeline. XXXX is the project code of the faulted IDU. 3s later, error code is displayed. For example, IDU no. 100 has d5 error, then LED3 displays like this: 01 (2s later) 00 (2s later) d5, and repeat again.

Step 17: if there's no error during operation for about 30min, system will automatically confirm that debugging is finished and then stop. System resumes standby condition.

Step 18: After debugging is finished, some functions can be set up according to project's actual needs. For specific details, please refer to System Functions Setup. If no special requirements, skip this step.

Step 19: deliver the product to user and inform user about usage precautions.

3.3.2.2 Commissioning through Commissioning Software

Step 1: Install commissioning software to the computer and connect monitoring communication cables (for details about the operation method, see the "GREE VRF Commissioning Software" section).

Step 2: Completely cover the front panel of ODU.

Step 3: In power-off status of ODU, set the ODU to a corresponding static pressure mode according to static pressure design requirements for outdoor engineering. For details about the setting method, see the "Outdoor Fan Static Pressure Setting DIP Switch (S2)" section. Silent mode setting method can also be seen in silent mode setting S1 of Technical service manual;

Step 4: In power-off status of ODU, set one module of ODU to master unit. For details about the setting method, see the "Master Unit Setting DIP Switch (S7)" section.

Step 5: Power on all outdoor and IDUs. In this case, ODU displays that the unit is in non-commissioning status "A0".

Step 6: Switch the commissioning software to the commissioning control interface.

Click "Debug" to switch to the engineering commissioning interface. The unit will automatically operate the commissioning modules listed in this interface from top to bottom. Note: The commissioning function only applies to the single-system network.

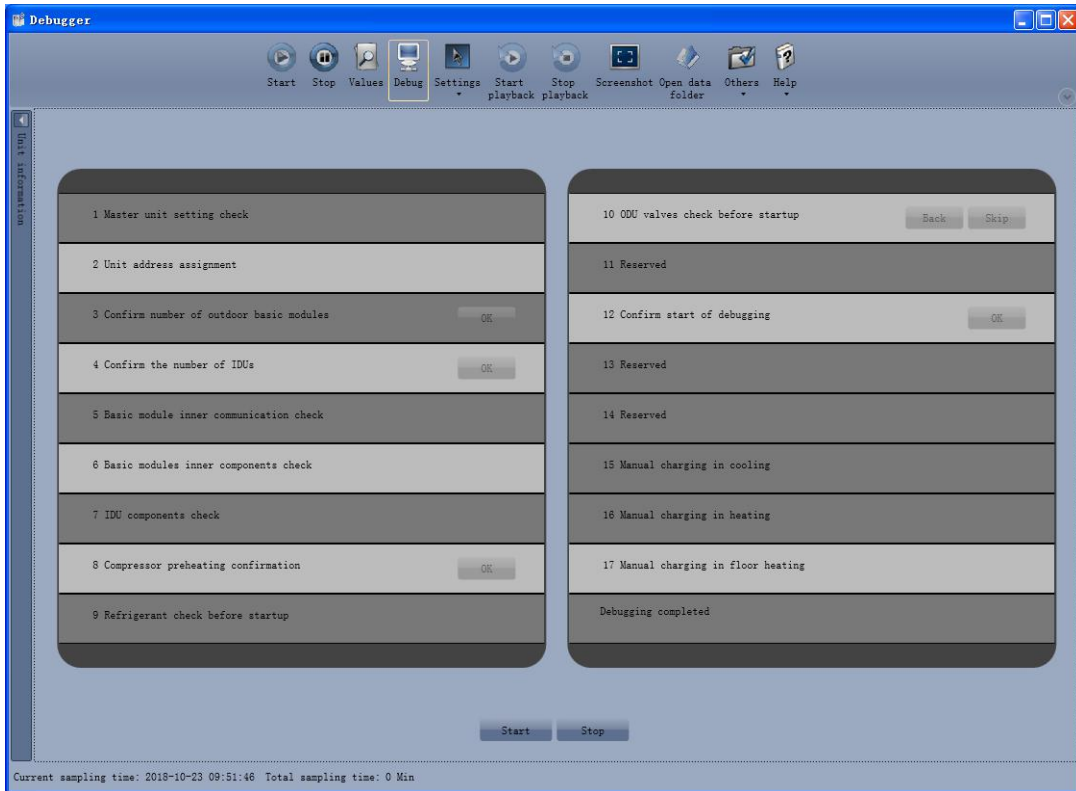

Click "Start" to enter the commissioning function and the software automatically performs commissioning. "🟡" indicates that commissioning is being performed on the phase and "🟢" indicates that commissioning is passed on the phase.

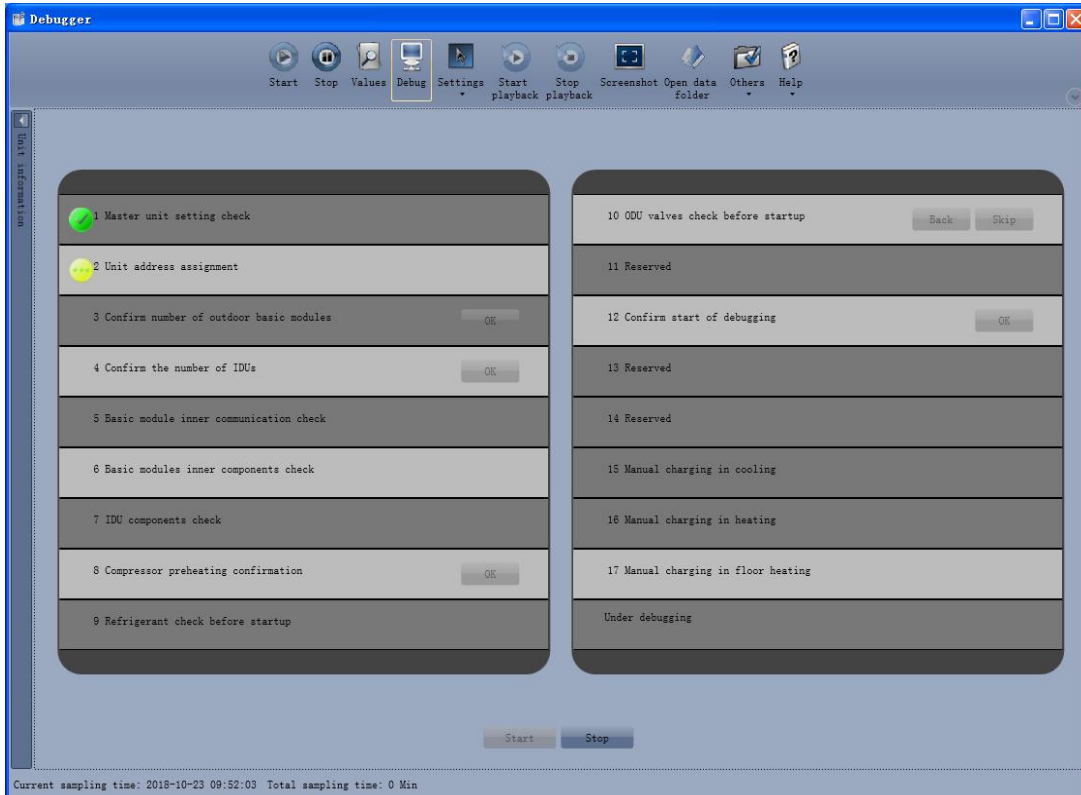

For the phase with "OK" displayed, a manual confirmation is required for entering the next commissioning step. Click "🟢" to display relevant information detected on this phase, which provides

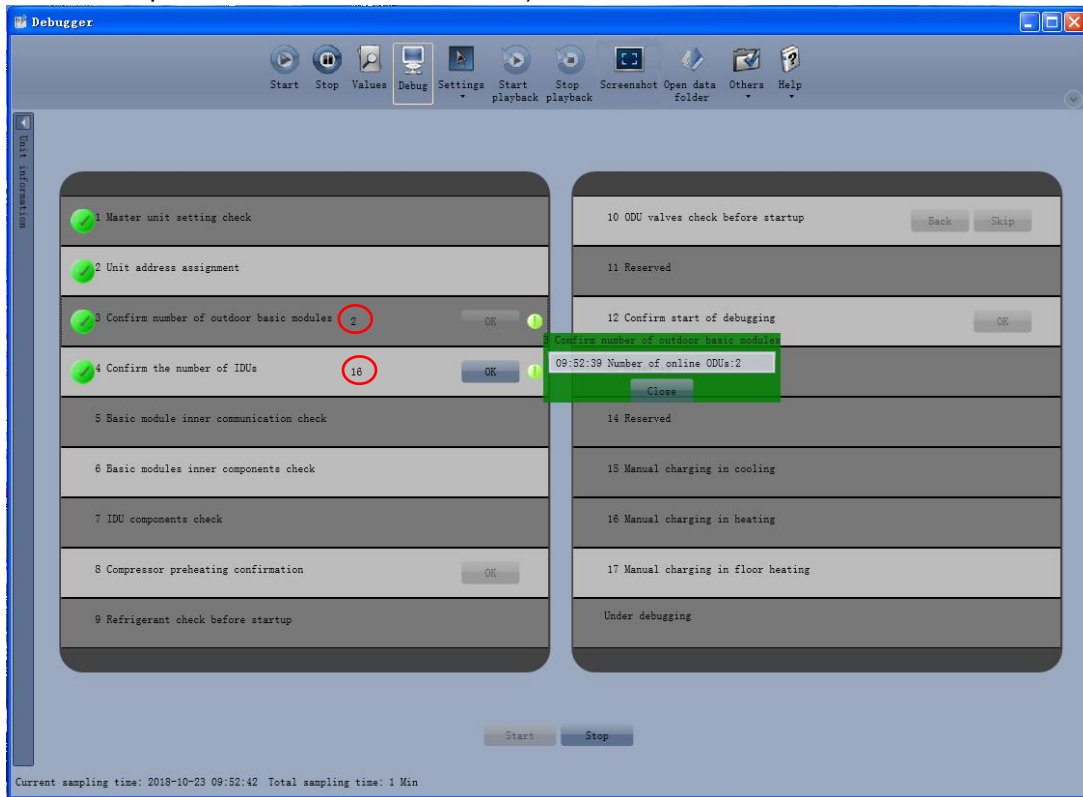

references for selection. Click "Close" to close the information (the number of commissioning units is displayed in "3 Confirm ODU Basic Module NO." and "4 Confirm IDU NO."; the preheating period is displayed in "8 Compressor Preheat Confirmation").

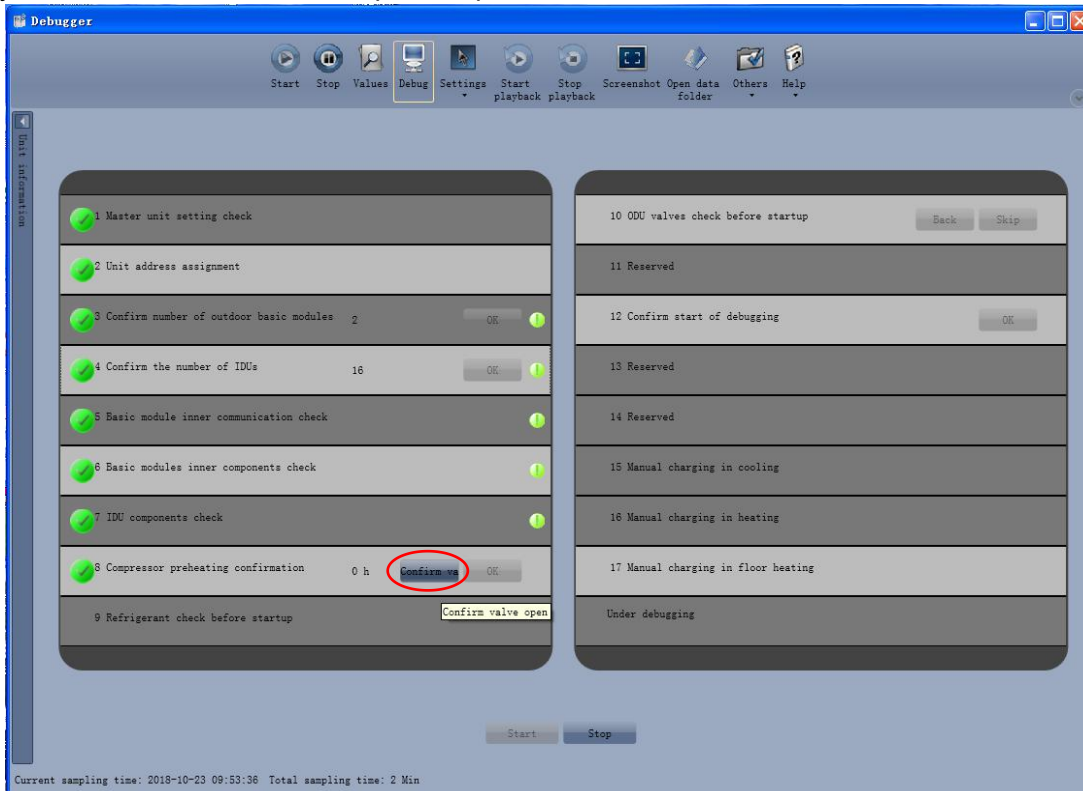

In the step "8 Compressor Preheat Confirmation", please confirm if the ODU valves are open manually at first, then confirm the compressor preheat time.

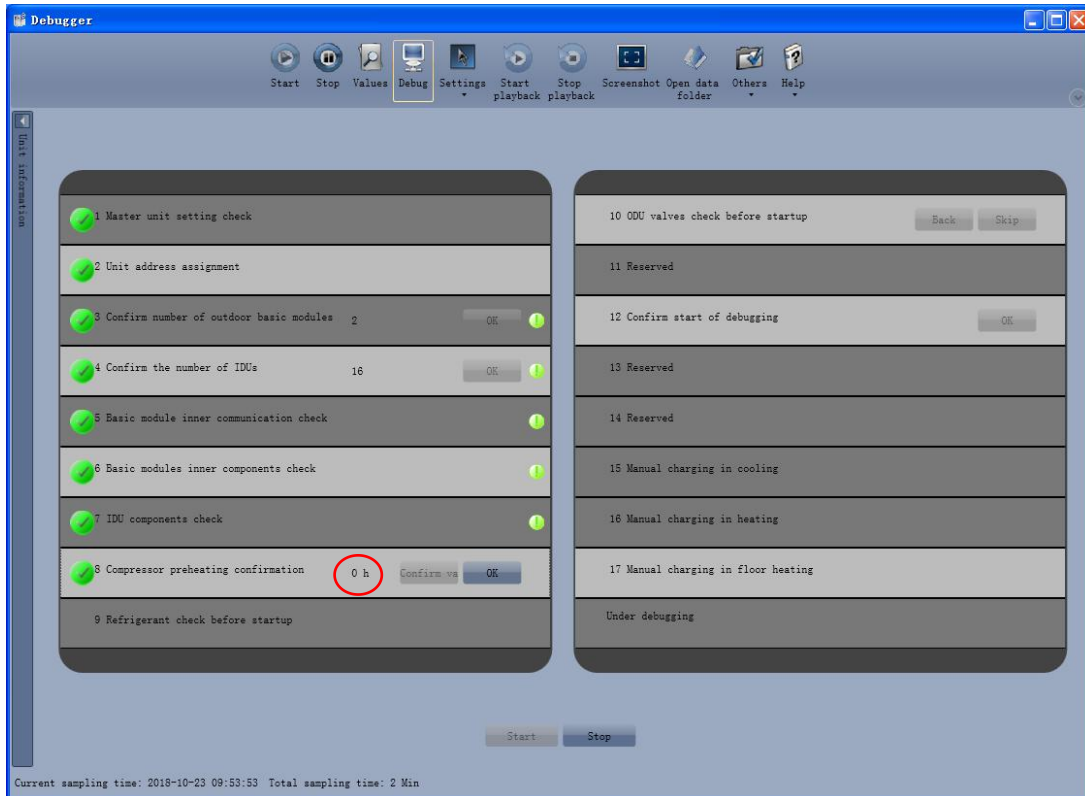



"" indicates that commissioning is not passed on the phase and troubleshooting is required (after troubleshooting, the unit automatically enters the next step if no "OK" exists or click "OK" to enter the next step). Click "" to display relevant information detected on this phase, which provides references for troubleshooting. Click "Close" to close the information.

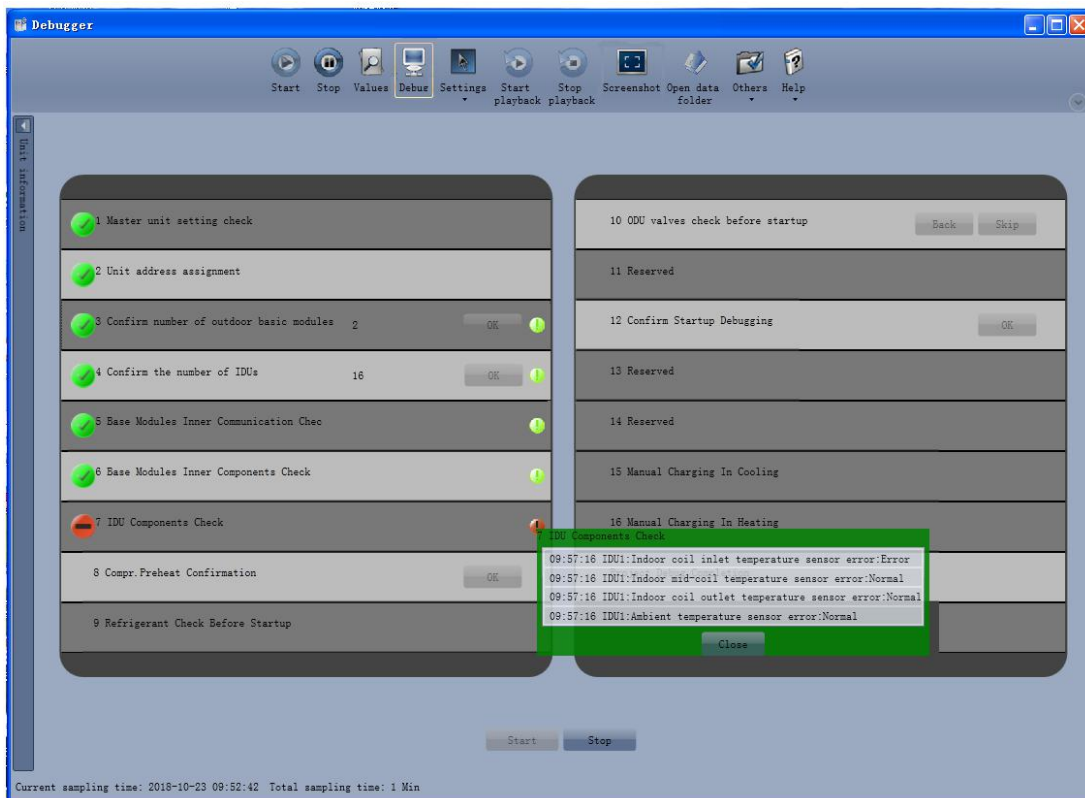

Commissioning step 10 and 17 are skipped, and commissioning step 11, 13 and 14 are reserved.

Step 13, 14, 15, and 16 are parallel steps (one of the five steps will be selected according to the actual unit). At last, engineering commissioning is completed when "✔" is displayed on "Debugging Complete".

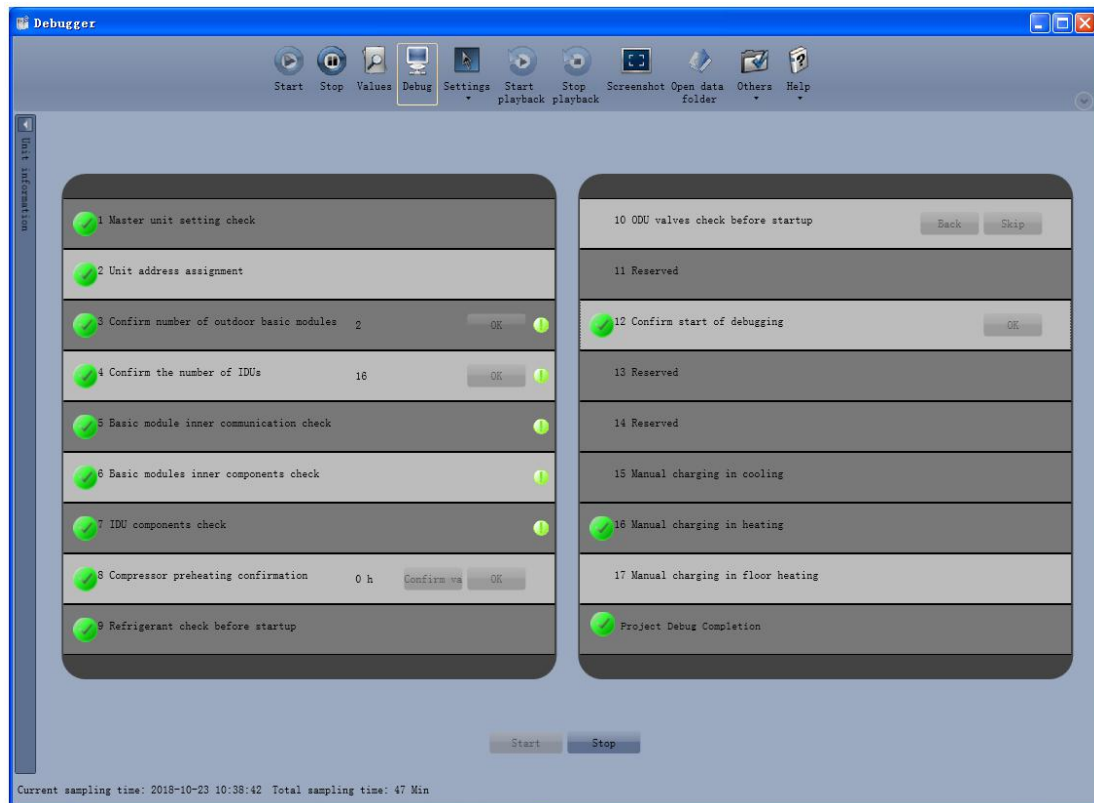
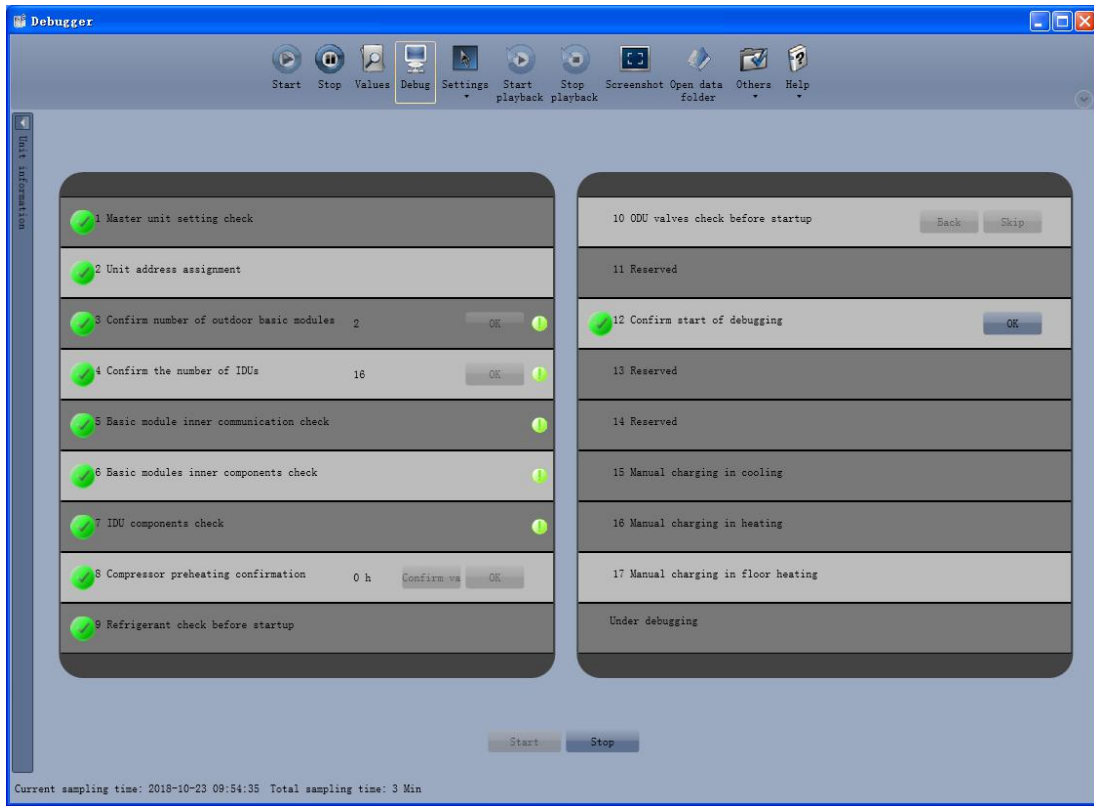

Then press " **Stop** ": Debugging complete, the steps of debugging information will be cleared and

new debugging process can be performed.

Note: During commissioning, users must listen to the operating sound of both outdoor and indoor fans and compressors to check for exceptions.

3.3.3 Operations after commissioning

Sort and save data. Make detailed records of exceptions and troubleshooting methods during commissioning for later maintenance and query. At last, make a commissioning report and hand it over to users.

3.3.4 Precautions to let users know after commissioning

(1) For heat pump, let users know where the master IDU is located and stick a label to the master IDU. Tell users that modes of other IDUs are limited by the mode of master IDU.

(2) An ODU that has been in power-off status for more than 24 hours should be preheated for more than eight hours before startup to prevent damaging compressors.

CHAPTER 4

MAINTENANCE

CHAPTER 4 MAINTENANCE

PART 1 FAILURE CODE TABLE

1 SYSTEM FAILURE CODE TABLE

Check the following items before contacting for repair.

Indoor:

Error Code	Content	Error Code	Content
L0	Malfunction of IDU	d2	Malfunction of lower water temperature sensor of water tank
L1	Protection of indoor fan	d3	Malfunction of ambient temperature sensor
L2	Auxiliary heating protection	d4	Malfunction of entry-tube temperature sensor
L3	Water-full protection	d6	Malfunction of exit-tube temperature sensor
L4	Abnormal power supply for wired controller	d7	Malfunction of humidity sensor
L5	Freeze prevention protection	d8	Malfunction of water temperature sensor
L7	No main IDU	d9	Malfunction of jumper cap
L8	Power supply is insufficient	dA	Web address of IDU is abnormal
L9	For single control over multiple units, number of IDU is inconsistent	dH	PCB of wired controller is abnormal
LA	For single control over multiple units, IDU series is inconsistent	dC	Setting capacity of DIP switch code is abnormal
LH	Alarm due to bad air quality	dL	Malfunction of air outlet temperature sensor
LC	IDU is not matching with ODU or IDU running mode is inconsistent with ODU allowed mode	dE	Malfunction of indoor CO2 sensor
LL	Malfunction of water flow switch	dF	Malfunction of upper water temperature sensor of water tank
LE	Rotation speed of EC DC water pump is abnormal	dJ	Malfunction of backwater temperature sensor
LF	Malfunction of shunt valve setting	dP	Malfunction of inlet tube temperature sensor of generator
LJ	Setting of functional DIP switch code is wrong	dU	Malfunction of drainage pipe temperature sensor of generator
LP	Zero-crossing malfunction of PG motor	db	Debugging status
LU	Indoor unit's branch is not inconsistent for one-to-more unit of heat recovery system	dd	Malfunction of solar power temperature sensor
d1	Indoor PCB is poor	dn	Malfunction of swing parts

Outdoor:

Error Code	Content	Error Code	Content
E0	Malfunction of ODU	FA	Limited frequency reduction for high pressure protection
E1	High-pressure protection	FH	Limited frequency reduction for low pressure protection
E2	Discharge low-temperature protection	FC	Limited frequency reduction for power protection
E3	Low-pressure protection	FL	Limited frequency reduction for IPM temperature protection
E4	High discharge temperature protection of compressor	FE	Current sensor of compressor 4 is abnormal
Ey	Outdoor ambient temperature is beyond normal range	FF	Current sensor of compressor 5 is abnormal
En	compressor power protection	FJ	Current sensor of compressor 6 is abnormal
J0	Protection for other modules	FP	Malfunction of DC motor
J1	Over-current protection of compressor 1	FU	Malfunction of casing top temperature sensor of compressor 1
J2	Over-current protection of compressor 2	Fb	Malfunction of casing top temperature sensor of compressor 2
J3	Over-current protection of compressor 3	Fd	Malfunction of exit tube temperature sensor of mode exchanger
J4	Over-current protection of compressor 4	Fn	Malfunction of inlet tube temperature sensor of mode exchanger
J5	Over-current protection of compressor 5	b1	Malfunction of outdoor ambient temperature sensor
J6	Over-current protection for compressor 6	b2	Malfunction of defrosting temperature sensor 1
J7	Gas-mixing protection of 4-way valve	b3	Malfunction of defrosting temperature sensor 2
J8	High pressure ratio protection of system	b4	Malfunction of liquid temperature sensor of sub-cooler
J9	Low pressure ratio protection of system	b5	Malfunction of gas temperature sensor of sub-cooler
JA	Protection because of abnormal pressure	b6	Malfunction of inlet tube temperature sensor of vapor liquid separator
JC	Water flow switch protection	b7	Malfunction of exit tube temperature sensor of vapor liquid separator
JL	Protection because high pressure is too low	b8	Malfunction of outdoor humidity sensor
JE	Oil-return pipe is blocked	b9	Malfunction of gas temperature sensor of heat exchanger
JF	Oil-return pipe is leaking	bA	Malfunction of oil-return temperature sensor 1
P0	malfunction of driving board of compressor	bH	Clock of system is abnormal
P1	Driving board of compressor operates abnormally	bC	Protection because the temperature sensor at the top of compressor 1 is loose
P2	Voltage protection of driving board power of compressor	bL	Protection because the temperature sensor at the top of compressor 2 is loose
P3	Reset protection of driving module of compressor	bE	Malfunction of inlet tube temperature sensor of condenser
P4	Drive PFC protection of compressor	bF	Malfunction of outlet tube temperature sensor of condenser
P5	Over-current protection of inverter compressor	bJ	High-pressure sensor and low-pressure sensor are connected reversely
P6	Drive IPM module protection of compressor	bP	Malfunction of temperature sensor of oil-return 2
P7	Malfunction of drive temperature sensor of compressor	bU	Malfunction of temperature sensor of oil return 3

Error Code	Content	Error Code	Content
P8	Drive IPM high temperature protection of compressor	bb	Malfunction of temperature sensor of oil return 4
P9	Desynchronizing protection of inverter compressor	H0	Malfunction of driving board of fan
PA	Malfunction of drive storage chip of compressor	H1	Driving board of fan operates abnormally
PH	High-voltage protection of compressor's drive DC bus bar	H2	Voltage protection of driving board power of fan
PC	Malfunction of current detection circuit drive of compressor	H3	Reset protection of driving module of fan
PL	Low voltage protection for DC bus bar of drive of compressor	H4	Drive PFC protection of fan
PE	Phase-lacking of inverter compressor	H5	Over-current protection of inverter fan
PF	Malfunction of charging loop of driven of compressor	H6	Drive IPM module protection of fan
PJ	Failure startup of inverter compressor	H7	Malfunction of drive temperature sensor of fan
PP	AC current protection of inverter compressor	H8	Drive IPM high temperature protection of fan
PU	AC input voltage of drive of inverter compressor	H9	Desynchronizing protection of inverter fan
Pn	Drive IPM high temperature protection of PFC	HA	Malfunction of drive storage chip of inverter outdoor fan
F0	Main board of ODU is poor	HH	High-voltage protection of fan's drive DC bus bar
F1	Malfunction of high-pressure sensor	HC	Malfunction of current detection circuit of fan drive
F2	Malfunction of middle-pressure sensor	HL	Low voltage protection of bus bar of fan drive
F3	Malfunction of low-pressure sensor	HE	Phase-lacking of inverter fan
F5	Malfunction of discharge temperature sensor of compressor 1	HF	Malfunction of charging loop of fan drive
F6	Malfunction of discharge temperature sensor of compressor 2	HJ	Failure startup of inverter fan
F7	Malfunction of discharge temperature sensor of compressor 3	HP	AC current protection of inverter fan
F8	Limited frequency reduction for AC current protection	HU	AC input voltage of drive of inverter fan
F9	Limited frequency reduction for discharge temperature protection	L6	IDU running mode is inconsistent with ODU allowed mode

Debugging:

Error Code	Content	Error Code	Content
U0	Preheat time of compressor is insufficient	C6	Alarm because ODU quantity is inconsistent
U2	Wrong setting of ODU's capacity code/jumper cap	C7	Abnormal communication of converter
U3	Power supply phase sequence protection	C8	Emergency status of compressor
U4	Refrigerant-lacking protection	C9	Emergency status of fan
U5	Wrong address for driving board of compressor	CA	Emergency status of module
U6	Alarm because valve is abnormal	CH	Rated capacity is too high
U8	Malfunction of pipeline for IDU	CC	No main outdoor unit
U9	Malfunction of pipeline for ODU	CL	The matching ratio of rated capacity for IDU and ODU is too low
UC	Setting of main IDU is succeeded	CE	Communication malfunction between mode

Error Code	Content	Error Code	Content
			exchanger and IDU
UL	Emergency operation DIP switch code of compressor is wrong	CF	Malfunction of multiple main control units
UE	Charging of refrigerant is invalid	CJ	Address DIP switch code of system is shocking
UF	Identification malfunction of IDU of mode exchanger	CP	Malfunction of multiple wired controller
C0	Communication malfunction between IDU, ODU and IDU's wired controller	CU	Communication malfunction between IDU and the receiving lamp
C1	Communication malfunction between main control and DC-DCcontroller	Cb	Overflow distribution of IP address
C2	Communication malfunction between main control and inverter compressor driver	Cd	Communication malfunction between mode exchanger and ODU
C3	Communication malfunction between main control and inverter fan driver	Cn	Malfunction of network for IDU and ODU of mode exchanger
C4	Malfunction of lack of IDU	Cy	Communication malfunction of mode exchanger
C5	Alarm because project code of IDU is inconsistent		

Status:

Error Code	Content	Error Code	Content
A0	Unit waiting for debugging	Ay	Shielding status
A2	Refrigerant recovery operation of after-sales	n0	SE operation setting of system
A3	Defrosting	n3	Compulsory defrosting
A4	Oil-return	n4	Limit setting for max. capacity/output capacity
A6	Heat pump function setting	n5	Compulsory excursion of engineering code of IDU
A7	Quiet mode setting	n6	Inquiry of malfunction
A8	Vacuum pump mode	n7	Inquiry of parameters
AH	Heating	n8	Inquiry of project code of IDU
AC	Cooling	n9	Check quantity of IDU on line
AL	Charge refrigerant automatically	nA	Heat pump unit
AE	Charge refrigerant manually	nH	Heating only unit
AF	Fan	nC	Cooling only unit
AJ	Cleaning reminding of filter	nE	Negative code
AP	Debugging confirmation when starting up the unit	nF	Fan model
AU	Long-distance emergency stop	nJ	High temperature prevention when heating
Ab	Emergency stop of operation	nU	Eliminate the long-distance shielding command of IDU
Ad	Limit operation	nb	Bar code inquiry
An	Child lock status	nn	Length modification of connection pipe of ODU

Note: For detailed malfunction and maintenance, please refer to the engineering debugging and after-sales maintenance manual.

2 ODU LEDS TABLE

On the master ODU AP7, there are three LEDs and the flashing meaning is:

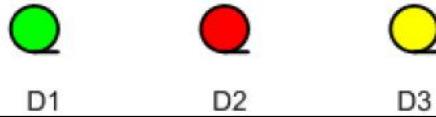

Flicker Times	Green	Red	Yellow
1	Drive board	Outdoor unit is always at ON status	Fan ON
2	Reservation	Reservation	Compressor ON
3	Reservation	Oil return	IPM Overcurrent for fan
4	PC monitor	Defrosting	IPM Overcurrent for compressor
5	Indoor unit 1	Limited frequency reduction for IPM temperature protection	Fan IPM protection
6	Indoor unit 2	Limited frequency reduction for PFC temperature protection	Compressor IPM protection
7	Indoor unit 3	Limited frequency reduction for AC current protection	PFC overcurrent
8	Indoor unit 4	Limited frequency reduction for power protection	PFC protection
9	Indoor unit 5	Limited frequency reduction for discharge temperature protection	Low voltage protection
10	Indoor unit 6	Limited frequency reduction for low pressure protection	High voltage protection
11	Indoor unit 7	Limited frequency reduction for high pressure protection	Low pressure protection
12	Indoor unit 8	Malfunction of discharge temperature sensor of compressor 1	High pressure protection
13	Indoor unit 9	Malfunction of outdoor ambient temperature sensor	High-pressure switch protection
14	Indoor unit 10	Malfunction of outdoor defrosting temperature sensor	Drive charging circuit malfunction of compressor
15	Indoor unit 11	Malfunction of suction temperature sensor	AC current protection
16	Indoor unit 12	Malfunction of sub-cooler liquid tube temperature sensor	Malfunction of EEPROM chip
17	Indoor unit 13	Malfunction of sub-cooler gas tube temperature sensor	
18	Indoor unit 14	Malfunction of low-pressure sensor	
19	Indoor unit 15	Malfunction of high-pressure sensor	
20	Indoor unit 16	Fan protection	
21	Indoor unit 17	Malfunction of discharge temperature sensor of compressor 2	
22	Indoor unit 18	Malfunction of outlet temperature of gas-liquid separator	Phase-lacking of PFC
23	Indoor unit 19		Phase-reversed of PFC
24	Indoor unit 20		
25			
26			
27			
28			Reservation
29			Power protection of compressor
30			Discharge protection for compressor
31			Refrigerant-lacking protection

On the master ODU AP4 and AP6, there are two LEDs and the flashing meaning is:



D1



D2

Flicker Times	Green	Yellow
1	Drive board 1	Fan ON
2	PFC board 1	Compressor ON
3	Drive board 2	IPM Overcurrent for fan
4	PFC board 2	IPM Overcurrent for compressor
5		Fan IPM protection
6		Compressor IPM protection
7		PFC overcurrent
8		PFC protection
9		Low voltage protection
10		High voltage protection
11		
12		
13		
14		Drive charging circuit malfunction of compressor
15		
16		
17		Protection of fan AC current
18		Phase-lacking of fan
19		Protection of compressor AC current
20		Phase-lacking of compressor
21		Protection of PFC AC current
22		Phase-lacking of PFC
23		Phase-reversed of PFC

PART 2 EXCEPTIONS AND TROUBLESHOOTING

1 HOW TO LOCATE A FAULTY IDU PROMPTLY

Use the IDU project number enquiry and faulty IDU locating function to locate a faulty IDU or wired controller's corresponding IDU as follows when multiple IDUs are running in one place:

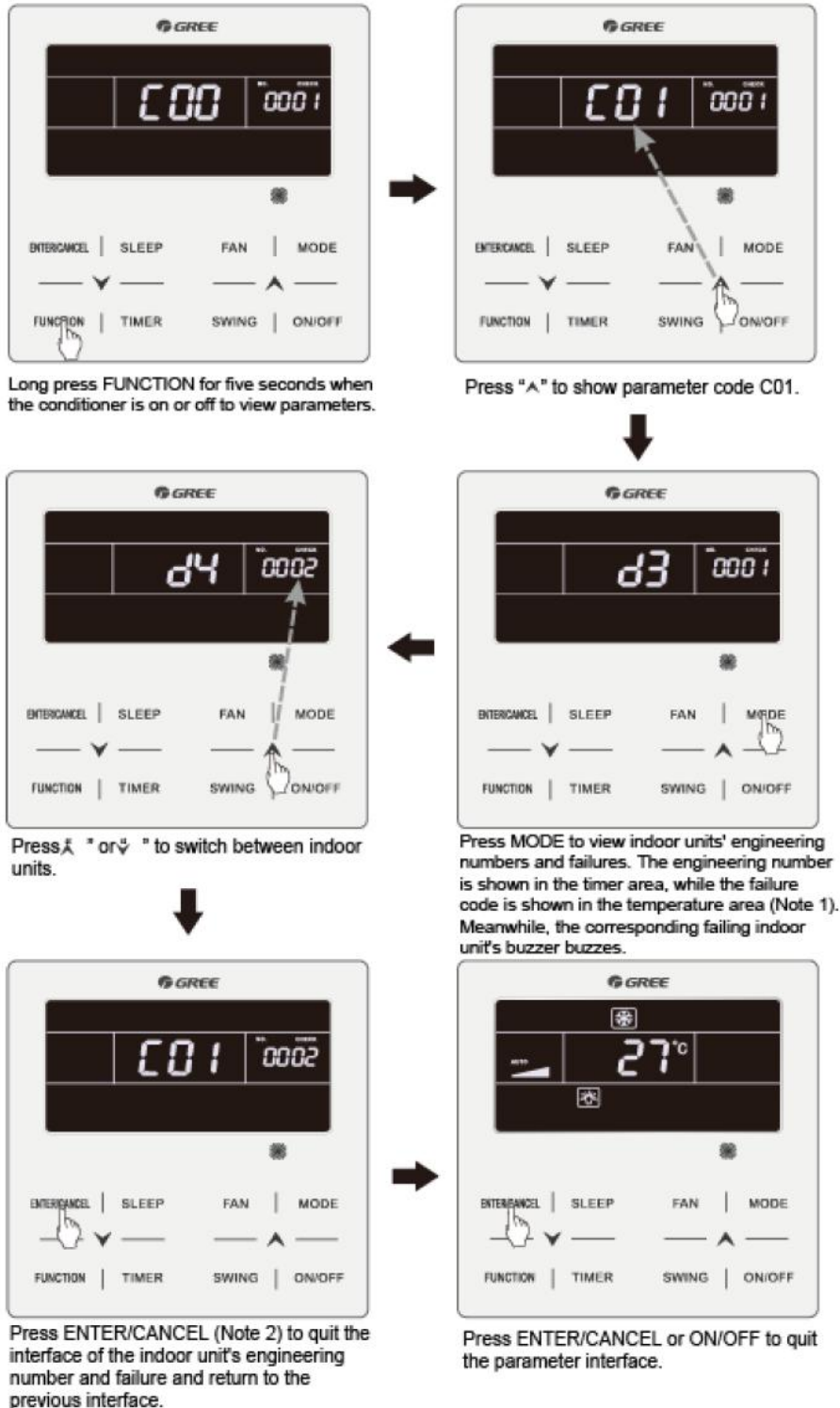

C01 Indoor project number and fault enquiry

NOTE1: If the enquired IDU is normal, no fault code will be displayed in the temperature area; if the unit indoor has multiple faults, fault codes will be displayed in the temperature area at an interval of 3 seconds.

NOTE2: Press the “ON/OFF” button on the interface of IDU project number and fault enquiry to exist the parameter enquiry interface.

2 EXCEPTIONS ANALYZING AND TROUBLESHOOTING

2.1 Form Analyzing

Fault code	Fault	Possible reasons	Solution
C0	Communication failure between indoor and ODUs and IDU's communicator	1) The communication cable is not connected. 2) The communicator is disconnected. 3) The communication cable is poorly connected. 4) The communicator controller is faulty.	If C0 is not displayed on the main board of the ODU, check the network between the IDU and communicator. If C0 is displayed, check the network between the IDUs and ODUs and between the IDU and communicator as follows: 1) Check if the cables connecting the main board of the ODU and the IDU and connecting the IDU and communicator are loose. If yes, reconnect them; 2) Check if the cables connecting the main board and IDU and connecting the IDU and communicator are broken. If yes, replace the cables; 3) Check the contact of the communication cables; 4) Replace the main board. If the fault is solved, the main board is faulty. Replace the IDU. If the fault is solved, the IDU is faulty.
C2	Communication failure between main control board and inverter compressor drive	1) The communication cable is not connected. 2) The communicator is disconnected. 3) The communication cable is poorly connected. 4) The communicator is faulty.	1) Check if the cable connecting the main board and the compressor's drive board is loose. If yes, reconnect it; 2) Check if the cable connecting the main board and compressor's drive board is broken. If yes, replace the cable; 3) Check the contact of the communication cable connecting the main board and compressor's drive board; 4) Replace the main board. If the fault is solved, the main board is faulty. Replace the compressor's drive board. If the fault is solved, the compressor's drive board is faulty.
C3	Communication failure between main control board and variable frequency fan drive	1) The communication cable is not connected. 2) The communicator is disconnected. 3) The communication cable is poorly connected. 4) The communicator is faulty.	1) Check if the cable connecting the main board and the fan's drive board is loose. If yes, reconnect it; 2) Check if the cable connecting the fan's drive board and main board is broken. If yes, replace the cable; 3) Check the contact of the communication cable connecting the fan's drive board and main board; 4) Replace the main board. If the fault is solved, the main board is faulty. Replace the fan's drive board. If the fault is solved, the fan's drive board is faulty.
C5	Project number conflict	1) Multiple IDUs share one project number.	1) Change conflicting project numbers and ensure that no IDU's project number is repeated.
C6	Outdoor unit number inconsistency warning	1) Communication cables between ODUs are loose. 2) Communication cables between	1) If the communication cable is loose, reconnect it; 2) If the communication cable is broken, replace it; 3) Check contact of the communication cable;

		<p>ODUs are broken.</p> <p>3) Communication cables between ODU's are poorly connected.</p> <p>4) The control board is faulty.</p>	4) Replace the main board.
CC	No master ODU	<p>1) The S7 dial switch of the ODU is not switched to 00.</p> <p>2) The S7 dial switch of the ODU is faulty.</p>	<p>1) Switch the S7 dial switch of an ODU to 00;</p> <p>2) Replace the main board or switch an ODU's S7 dial switch to 00.</p>
CF	Multiple controlling units	<p>1) S7 dial switches of multiple ODU's are switched to 00.</p> <p>2) Dial switches of multiple ODU's are faulty.</p>	<p>1) Leave one S7 dial switch of an ODU to 00;</p> <p>2) Replace the control board or switch an ODU's S7 dial switch to 00.</p>
F0	Faults in the ODU's main board (such as memory and address chip exceptions)	<p>1) The clock chip on the main board is damaged.</p> <p>2) The memory chip on the main board is damaged.</p> <p>3) The address chip on the main board is damaged.</p>	<p>1) Replace the small CPU board;</p> <p>2) Replace the main board.</p>
L7	No master IDU	<p>1) The master IDU is powered off.</p> <p>2) The communication of the master IDU fails.</p> <p>3) The main board of the master IDU is faulty.</p> <p>4) No master IDU is set in the system.</p>	<p>1) Check if the master IDU is powered on. If yes, replace the main board;</p> <p>2) Check the contact of the communication cable of the master IDU. If no communication failure (C0) is reported, replace the main board.</p> <p>3) Replace the IDU's main board and reset the master IDU.</p> <p>4) Set the master IDU.</p>
U3	Power phase sequence protection	<p>1) The three-phase power cable is not connected correctly.</p> <p>2) The main board's detection circuit is faulty.</p>	<p>1) Check connection of the power cable.</p> <p>2) Replace the main board.</p>
P3	Compressor drive module reset protection	<p>1) The compressor drive board is faulty.</p>	1) Replace the compressor drive board.
P5	Inverter compressor over-current protection	<p>1) The drive board's IPM module is damaged;</p> <p>2) The compressor's UVW cable is not connected properly;</p> <p>3) The compressor is damaged.</p>	<p>1) Replace the compressor drive board;</p> <p>2) Reconnect the compressor's UVW cable;</p> <p>3) Replace the compressor.</p>
P6	Compressor drive IPM module protection	<p>1) The drive board's IPM module is damaged;</p> <p>2) The compressor's UVW cable is not connected properly;</p> <p>3) The compressor is damaged.</p>	<p>1) Replace the compressor drive board;</p> <p>2) Reconnect the compressor's UVW cable;</p> <p>3) Replace the compressor.</p>
P7	Compressor drive temperature sensor fault	<p>1) The compressor drive board is faulty.</p>	1) Replace the compressor drive board.
P8	Compressor drive IPM over-temperature protection	<p>1) The compressor drive board is faulty;</p> <p>2) Thermal gel is not applied evenly on the IPM module;</p> <p>3) The IPM module is not screwed properly.</p>	<p>1) Replace the compressor drive board;</p> <p>2) Apply thermal gel evenly on the IPM module;</p> <p>3) Screw the IPM module properly.</p>
P9	Inverter compressor out-of-step protection	<p>1) The compressor drive board is faulty.</p> <p>2) The compressor is damaged.</p>	<p>1) Replace the compressor drive board.</p> <p>2) Replace the compressor.</p>
PH	Compressor drive	<p>1) Does the voltage of the input</p>	1) Lower the voltage of the input power cable to the

	DC bus high voltage protection	power cable of the whole system exceed 800 V; 2) The compressor drive board is faulty.	required range; 2) Replace the compressor drive board.
PL	Compressor drive DC bus low voltage protection	1) Is the voltage of the input power cable of the whole system lower than 100 V; 2) The compressor drive board is faulty.	1) Elevate the voltage of the input power cable to the required range; 2) Replace the compressor drive board.
PC	Compressor drive current check circuit fault	1) The compressor drive board is faulty.	1) Replace the compressor drive board.
PF	Compressor drive recharging circuit fault	1) Is the voltage of the input power cable of the whole system lower than 60 V; 2) The compressor drive board is faulty.	1) Elevate the voltage of the input power cable to the required range; 2) Replace the compressor drive board.
PJ	Inverter compressor starting failure	1) The drive board is damaged; 2) The compressor's UVW cable is not connected properly; 3) The compressor is damaged.	1) Replace the compressor drive board; 2) Reconnect the compressor's UVW cable; 3) Replace the compressor.
H3	Fan drive module reset protection	1) The fan drive board is faulty.	1) Replace the fan drive board.
H5	Variable frequency fan over-current protection	1) The fan drive board's IPM module is damaged; 2) The fan's UVW cable is not connected properly; 3) The fan is damaged.	1) Replace the fan drive board; 2) Reconnect the fan's UVW cable; 3) Replace the fan.
H6	Fan drive IPM module protection	1) The fan drive board's IPM module is damaged; 2) The fan's UVW cable is not connected properly; 3) The fan is damaged.	1) Replace the fan drive board; 2) Reconnect the fan's UVW cable; 3) Replace the fan.
H7	Fan drive temperature sensor fault	1) The fan drive board is faulty.	1) Replace the fan drive board.
H8	Fan drive IPM over-temperature protection	1) The fan drive board is faulty; 2) Thermal gel is not applied evenly on the IPM module; 3) The IPM module is not screwed properly.	1) Replace the fan drive board; 2) Apply thermal gel evenly on the IPM module; 3) Screw the IPM module properly.
H9	Variable frequency fan out-of-step protection	1) The fan drive board is faulty. 2) The fan is damaged.	1) Replace the fan drive board. 2) Replace the fan.
HC	Fan drive current detection circuit fault	1) The fan drive board is faulty.	1) Replace the fan drive board.
HJ	Variable frequency fan starting failure	1) The drive board is damaged; 2) The fan's UVW cable is not connected properly; 3) The fan is damaged.	1) Replace the fan drive board; 2) Reconnect the fan's UVW cable; 3) Replace the fan.

NOTE: C5 fault means IDUs project numbers conflict with each other, which may happens in a cooling system or in different cooling systems controlled in a centralized way. Solution of C5 fault has two ways, one way is changing conflicting project numbers by wired controller according to owner's manual of

wired controller to ensure that no IDU's project number is repeated.

When C5 occurs on different cooling systems controlled in a centralized way, the C5 fault can be solved by debugging software or remote controller. If two or more IDUs share the same project number, the engineer number conflict occurs. In this case, IDUs cannot be switched to varied modes or be turned on or off. The whole device cannot be started before the conflict is solved.

1) Manual setting on the communicator and remote controller:

When the project number conflict occurs, you can use the communicator or remote controller to revise project numbers and solve the conflict. See the manual of the communicator or remote controller for the method.

2) Manual setting on the commissioning software:

Use the commissioning software to set IDUs' project numbers separately in every system or reset projects numbers in multiple systems.

When C5 occurs on different cooling systems controlled in a centralized way, the commissioning software will show the following page:

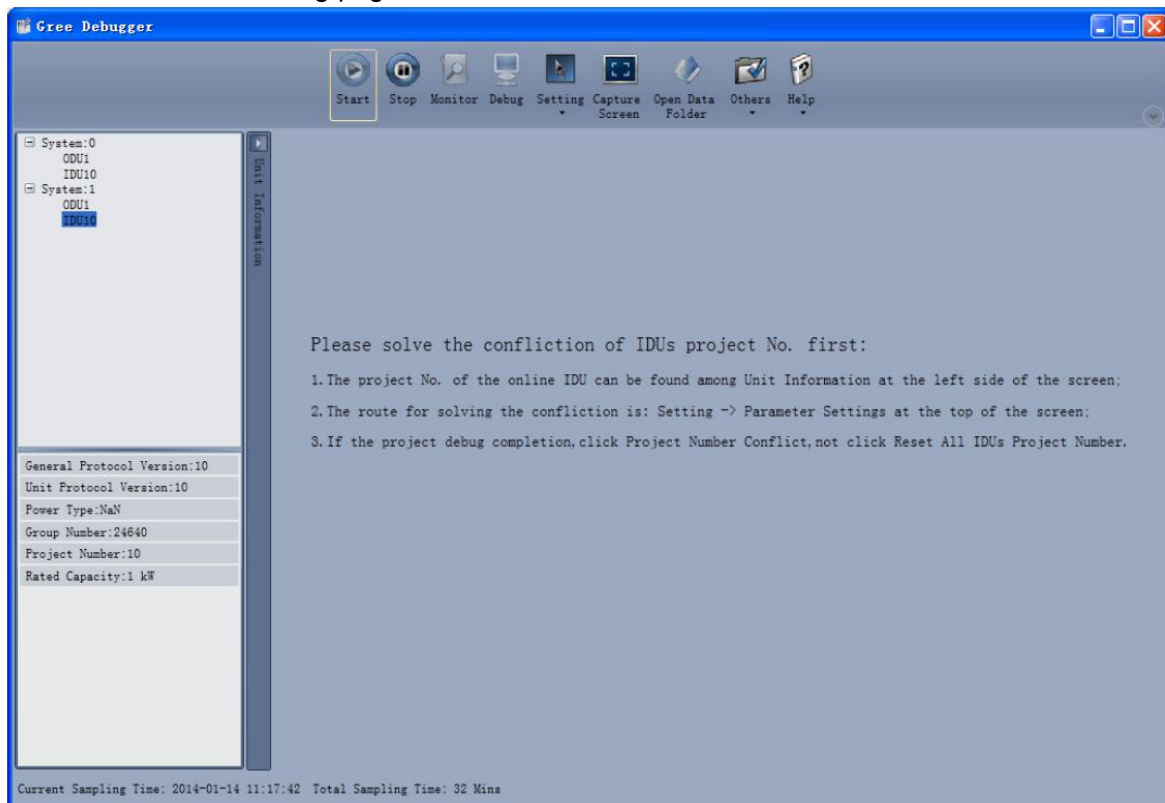

Fig.1

Choose Setting->Parameter Settings, as shown in Fig.2.

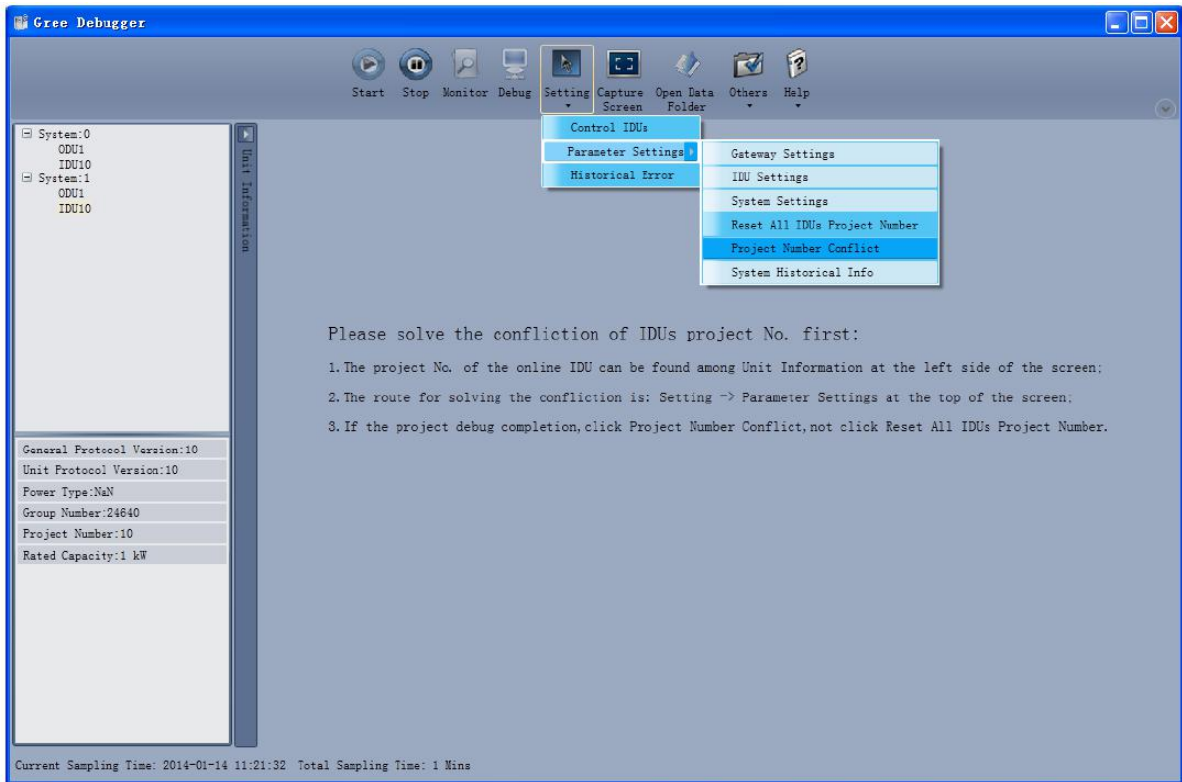

Fig.2

If project commissioning is finished and the IDU whose the conflict occurs needs to be set separately. Click Project Number Conflict, as shown in Fig.3. The pop-up box comprises two parts: conflicting IDU box, showing the IDU' s project number, system number and time; setting box, showing the IDU project number setting and setting button.

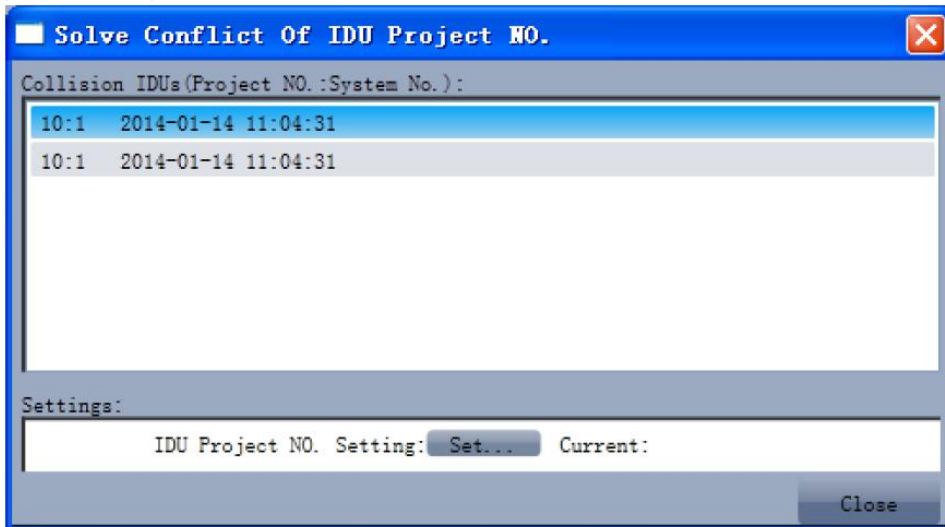

Fig.3

Choose one IDU in the conflicting IDU box shown in Fig.3 and click Set in the setting box. Choose a value in the pop-up box shown in Fig.4 and click Set.

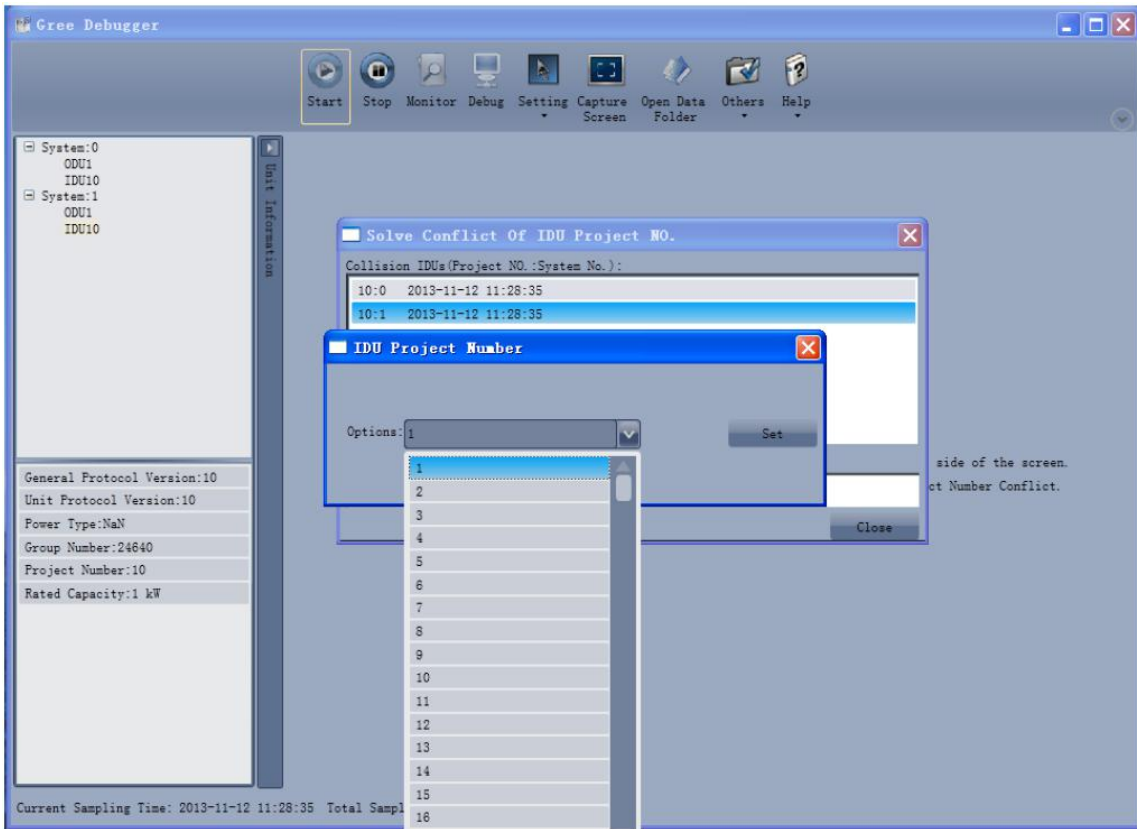

Fig.4

If the conflict is solved, the system will return to the normal status and IDUs can be operated, as shown in Fig.5.

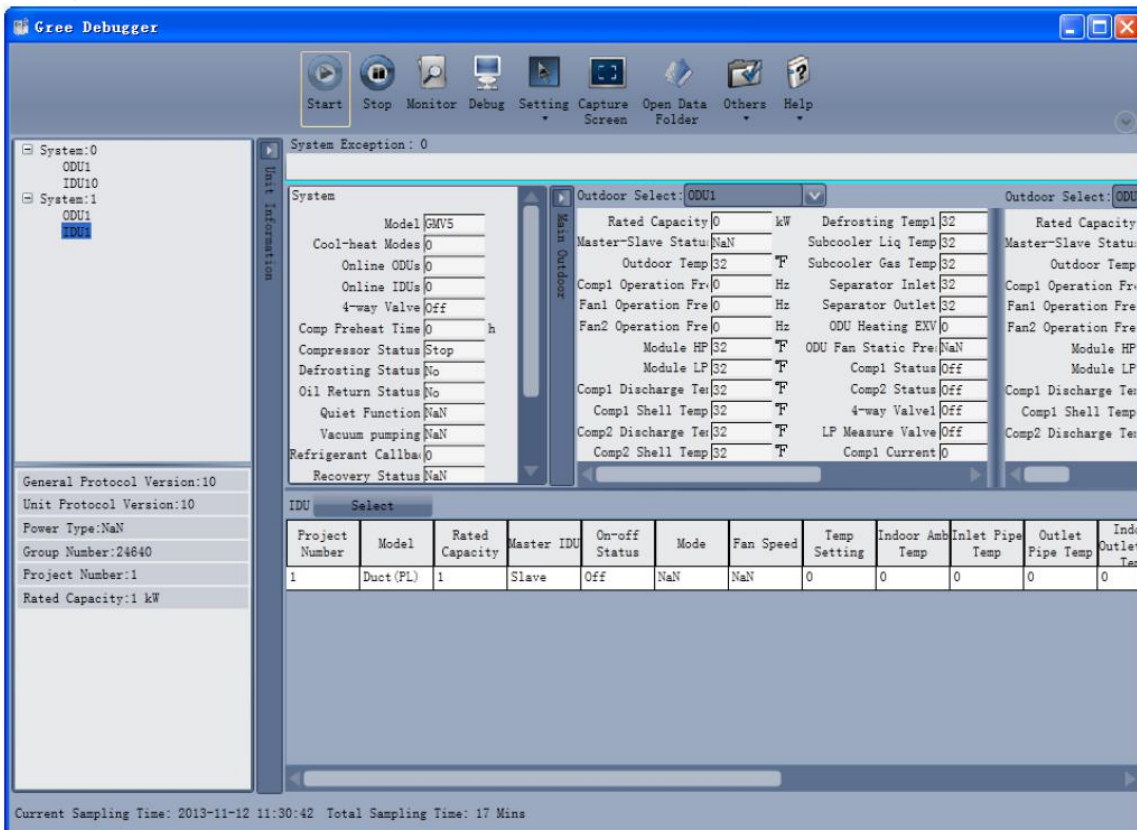

Fig.5

If project commissioning is not finished and all the IDUs' project numbers need to be reset, click Set All IDUs Project Number shown in Fig.2. As shown in Fig.6, the pop-up box comprises two parts: Systems Selection, where you can choose the system to be reset; Settings box, where you can give the resetting instruction.

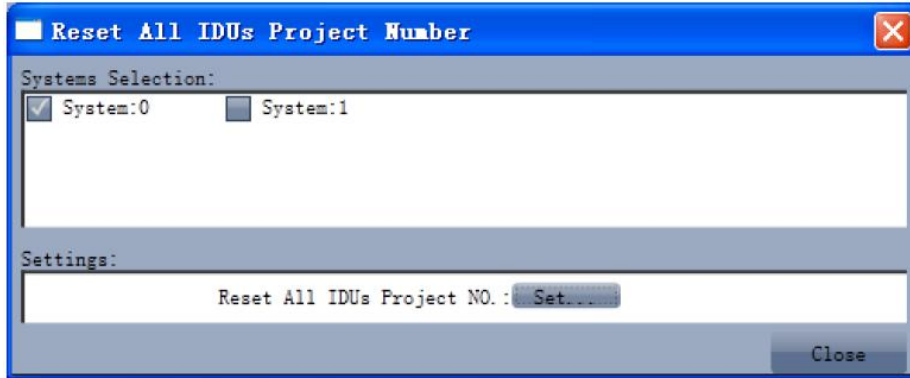

Fig.6

Choose one or multiple systems in the Systems Selection box and click Set in the Settings box, as shown in Fig.6. Click Set, as shown in Fig.7.

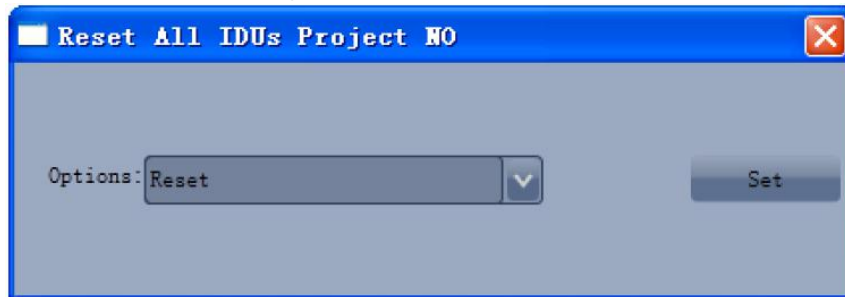

Fig.7

If the conflict is solved, the system will return to the normal status and IDUs can be operated as shown in Fig.5.

2.2 Flowchart Analyzing

- (1) High exhaust temperature protection (E4)

When the system shows high exhaust temperature protection for compressor, the IDU will show high exhaust temperature fault E4.

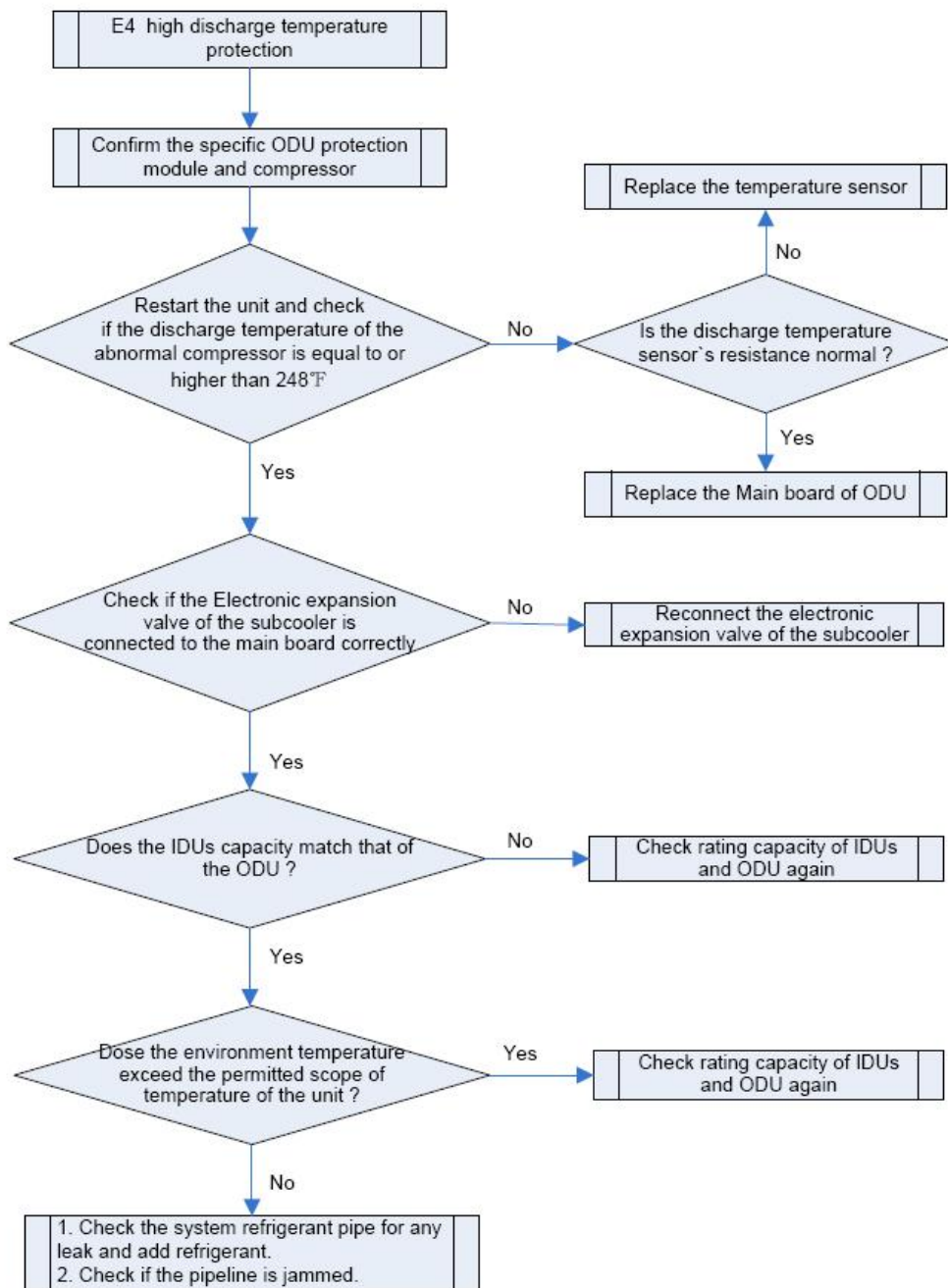

(2) System high pressure protection (E1)

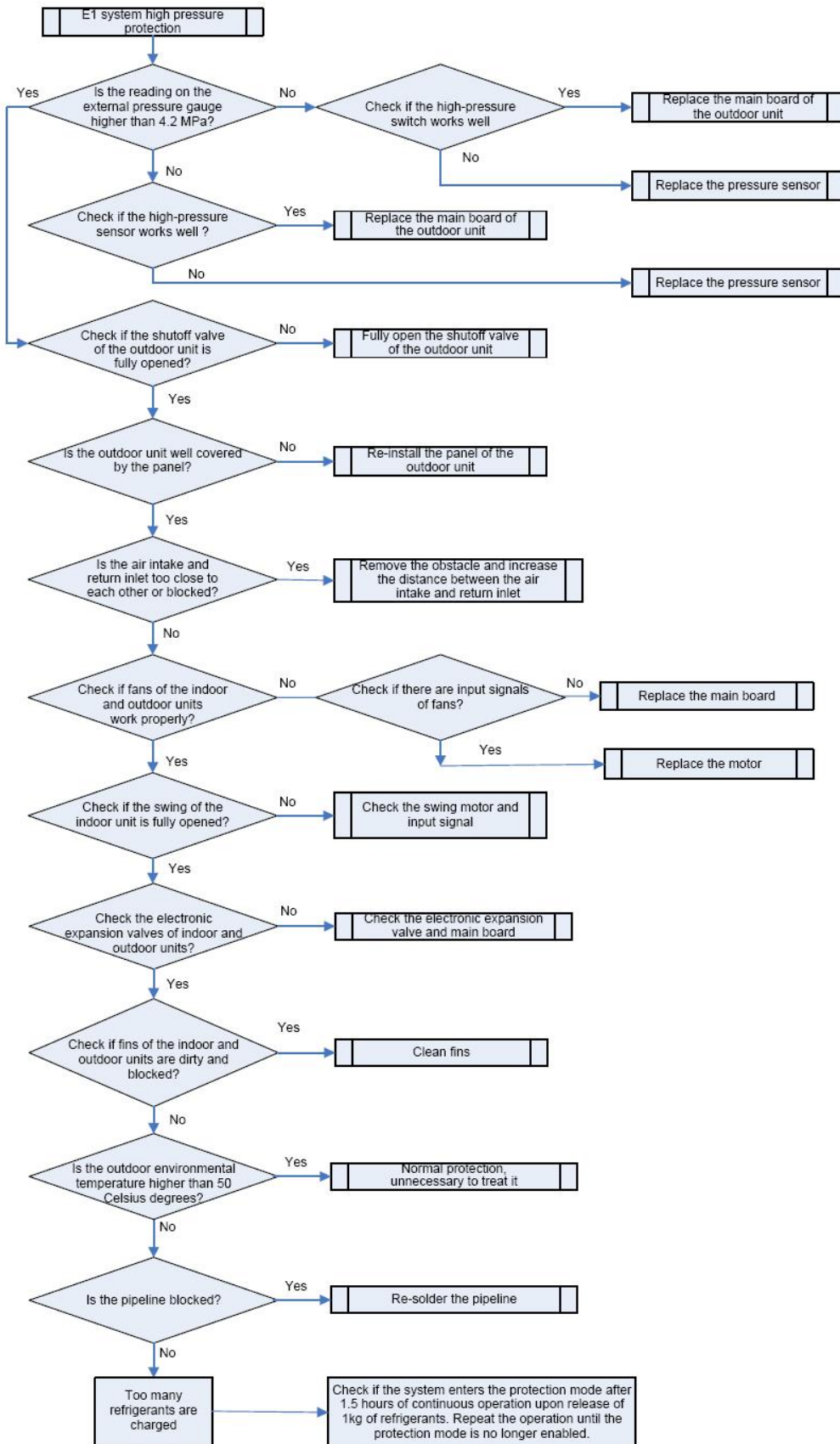

(3) System low pressure protection (E3)

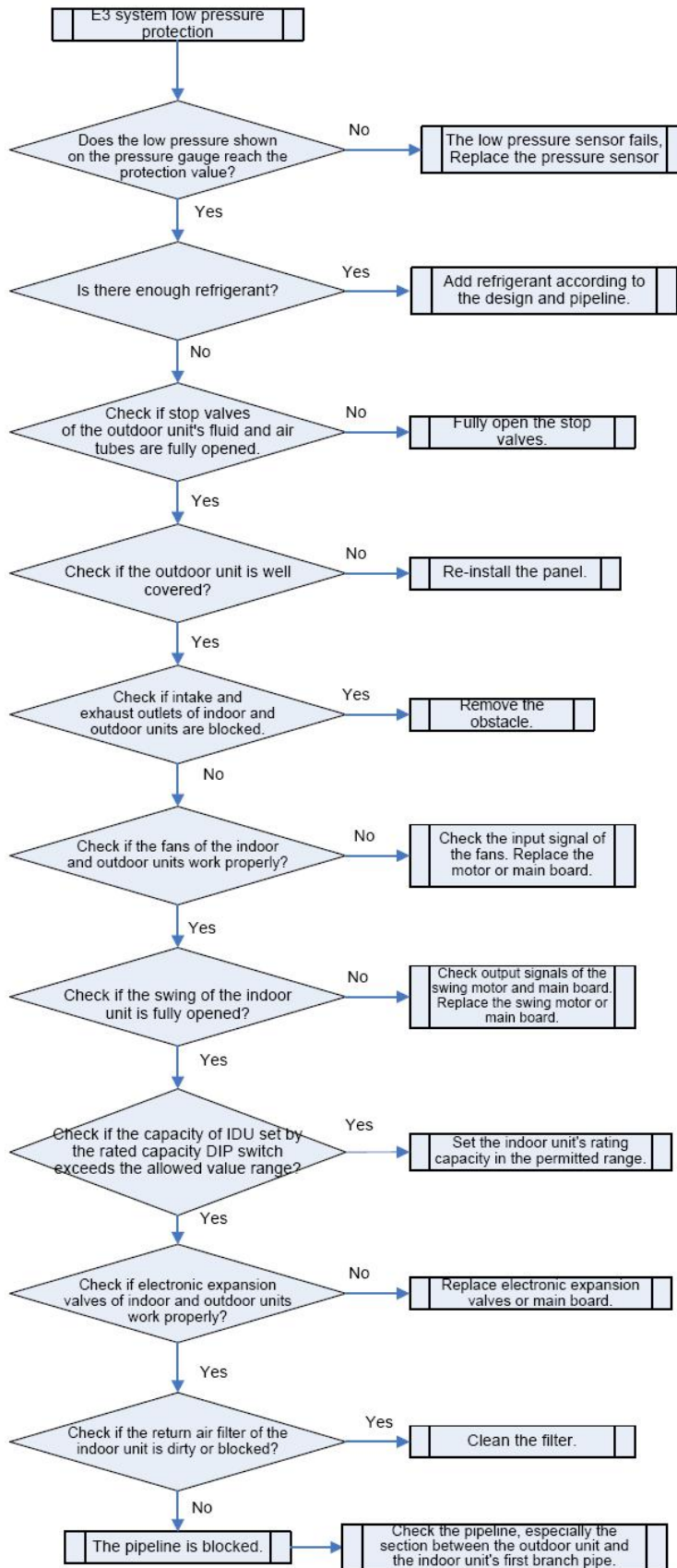

(4) System refrigerant lacking protection (U4)

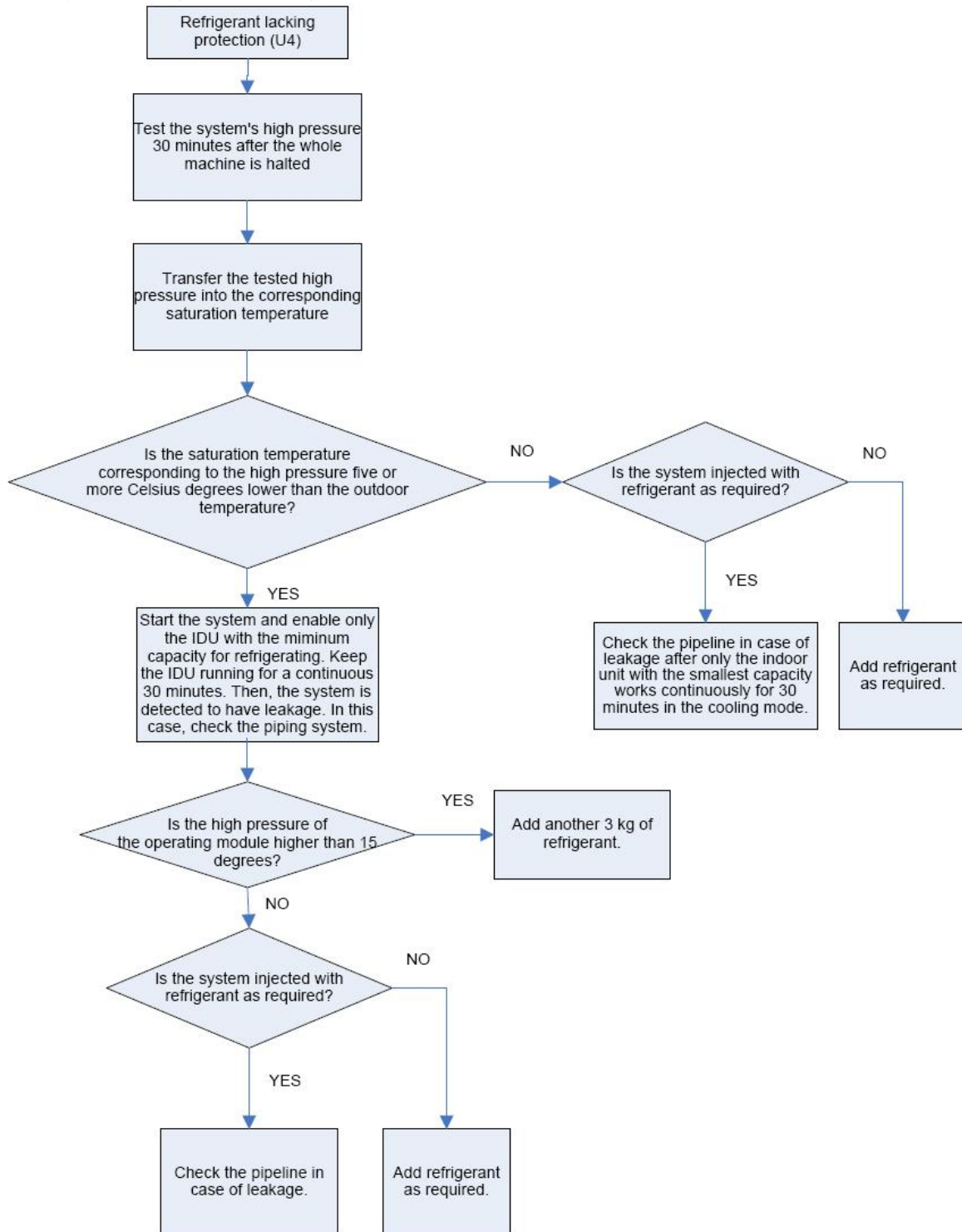

(5) Indoor unit anti-freezing protection (L5)

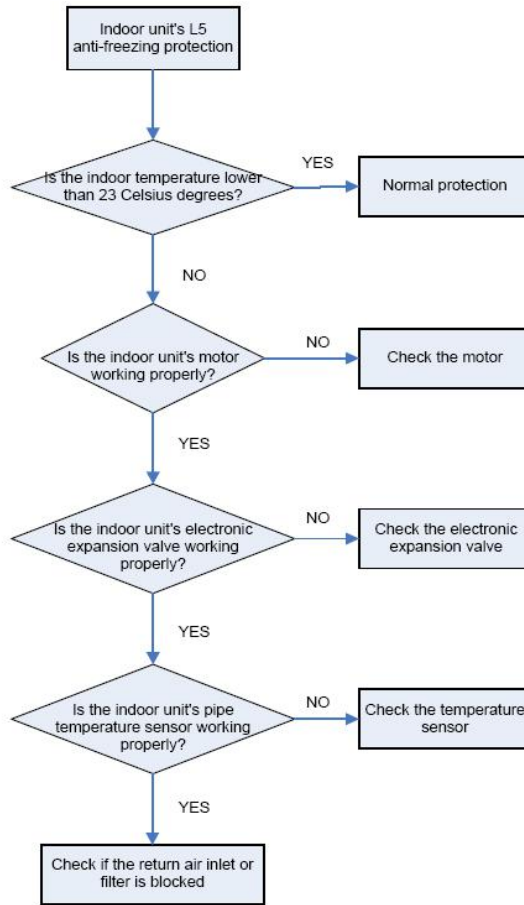

(6) Indoor unit water overflow protection (L3)

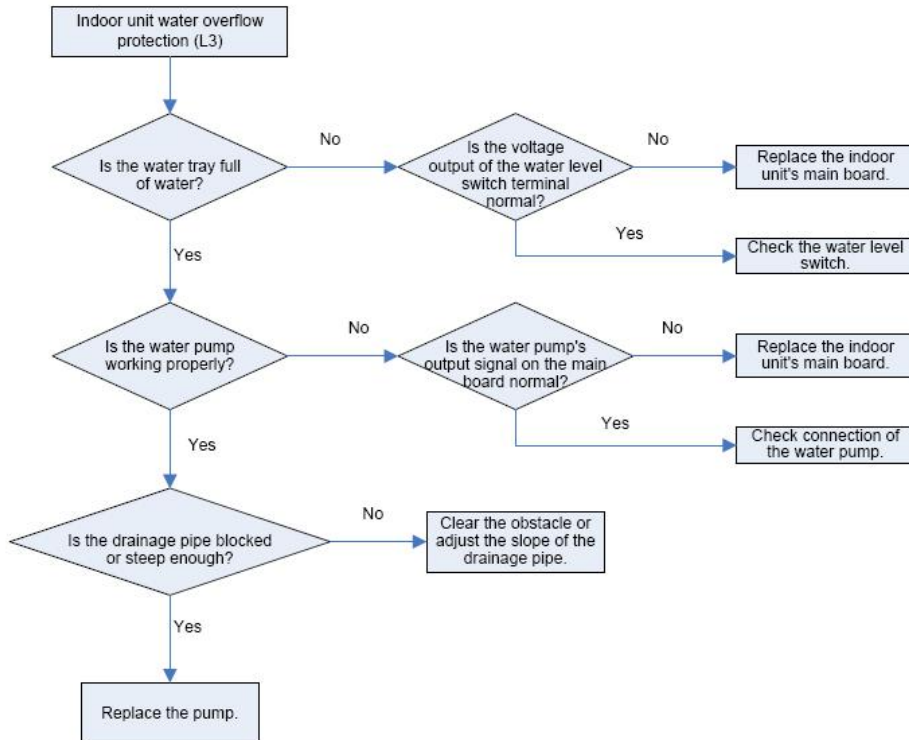

(7) Temperature sensor fault

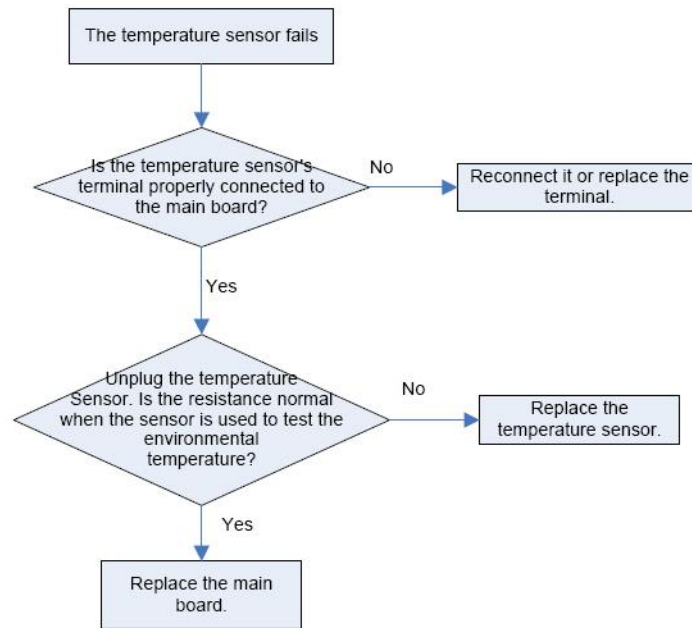

(8) Pressure sensor fault

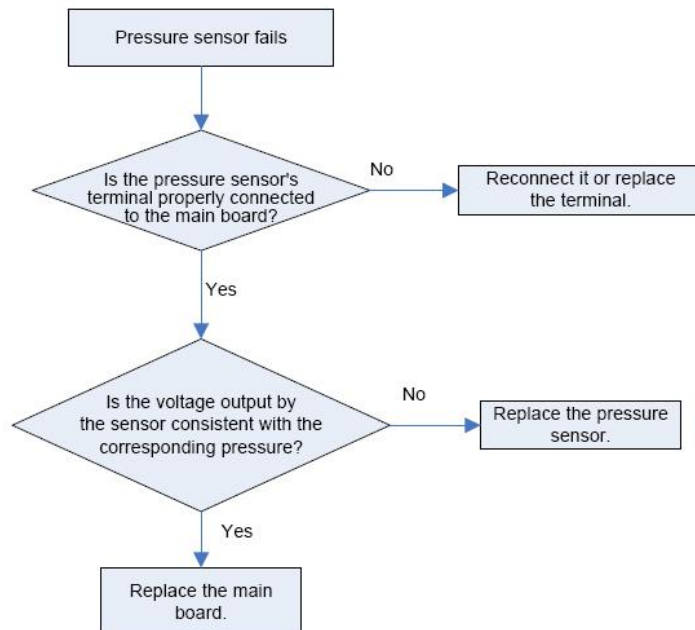

(9) Analyzing of drive control system faults

When the unit fails and halts, first check the two-digit nixie tube of the main board and fault table to find out the specific fault. Then check and solve the fault according to the following methods.

1) Communication failure between the compressor's drive board and control board (outdoor fault C2)

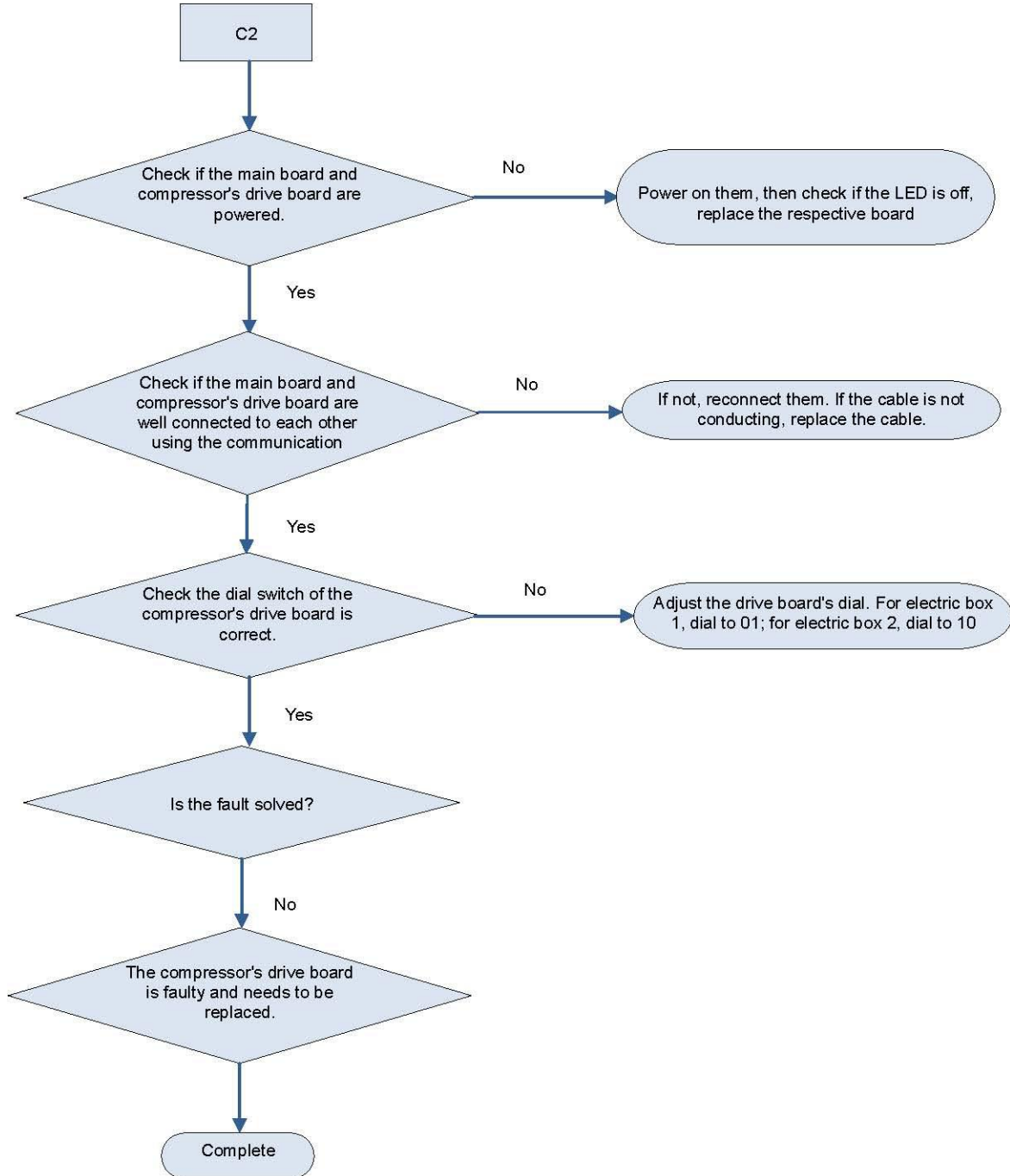

2) Faults in the current detection circuit drive of compressor (ODU fault PC) and out-of-step protection of compressor (ODU fault P9)

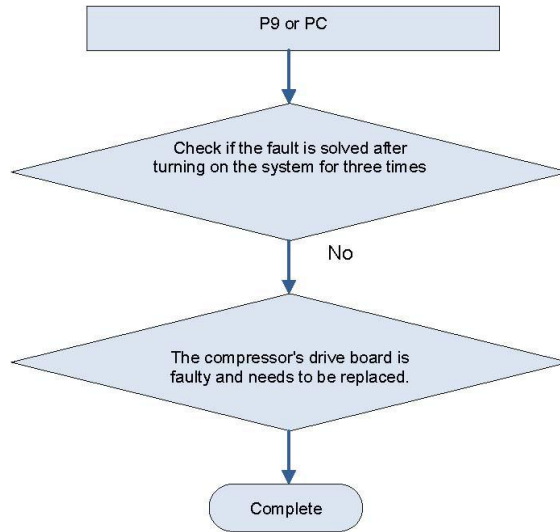

3) AC over-current protection (ODU fault P5) and IPM module over-current protection faults (ODU fault P6)

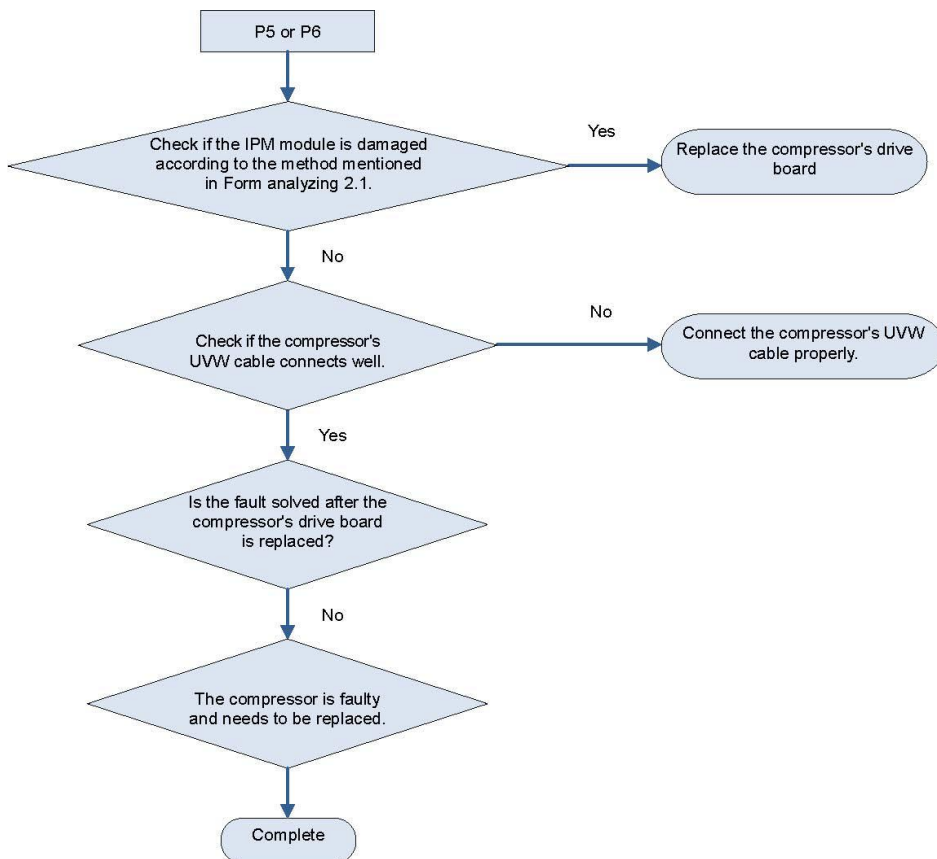

Attachment: How to check whether the IPM module is damaged

a. Preparation: Find a digital multi-meter and switch it to the diode. Remove U, V and W cables of the

compressor from the drive board two minutes after the system is powered off. Make sure that it is tested at least two minutes after the system is powered off. Then put the multi-meter to diode test step.

b. Drive board method: Use the black probe of the multi-meter to touch the place marked by P in the follow picture and the red probe to touch places marked by U, V and W respectively and record readings of the multi-meter. Use the red probe to touch the place marked by N and black probe to touch places marked by U, V and W respectively and record readings of the multi-meter.

PFC board method: Use the black probe of the multi-meter to touch the place marked by P in the follow picture and the red probe to touch places marked by L1, L2 and L3 respectively and record readings of the multi-meter. Use the red probe to touch the place marked by N and black probe to touch places marked by L1, L2 and L3 respectively and record readings of the multi-meter.

c. Analyzing: If the reading ranges between 0.3 V and 0.7 V in the above-mentioned six scenarios, the IPM module is normal. If the reading is 0 in one or multiple scenarios, the IPM module is damaged.

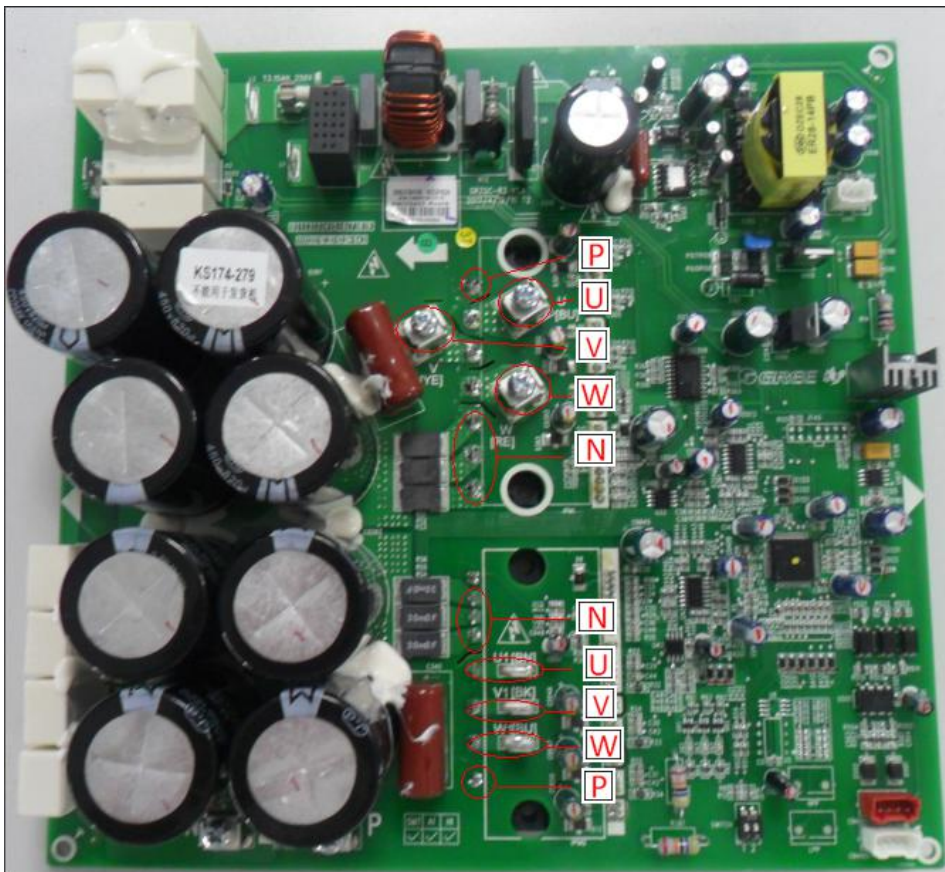

Drive board

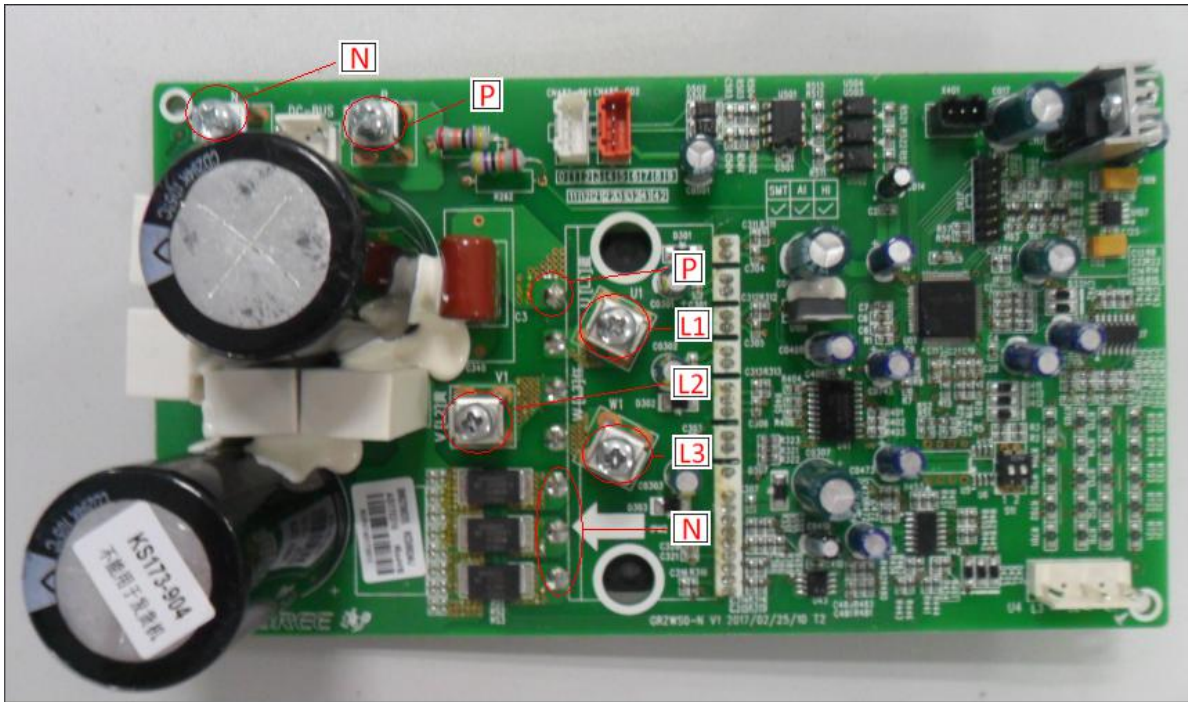

PFC board

4) Variable-frequency compressor drive board IPM over-temperature fault (ODU fault P8)

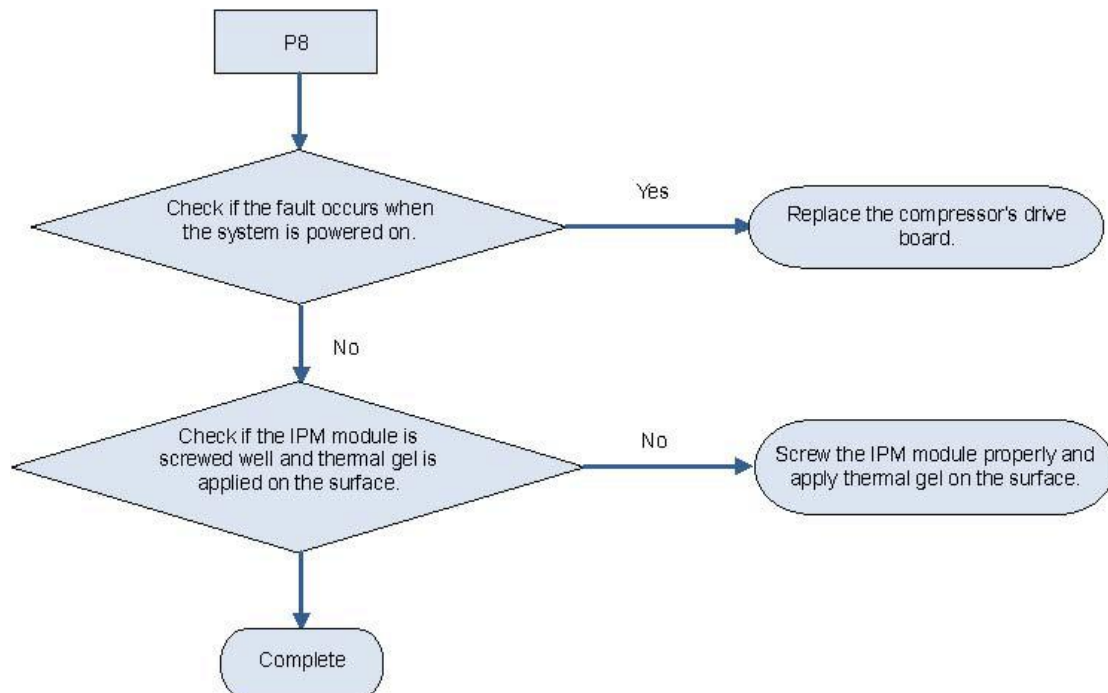

5) Recharging circuit faulty of the variable-frequency compressor drive board (ODU fault PF)

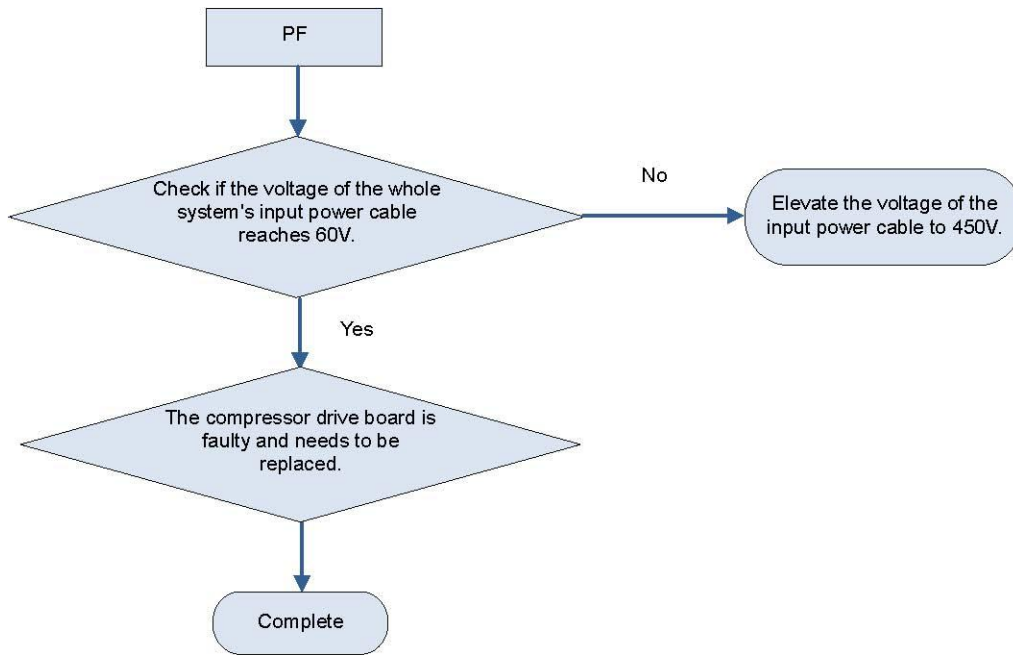

6) High voltage protection for the DC bus of the variable-frequency compressor's drive board (ODU fault PH)

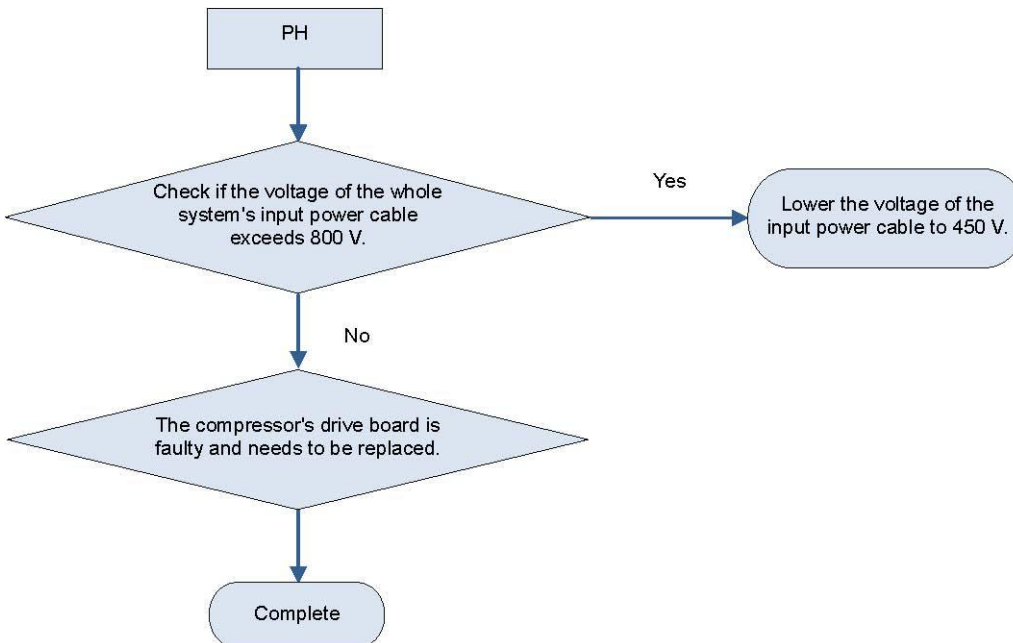

7) Low voltage protection for the DC bus of the variable-frequency compressor's drive board (ODU fault PL)

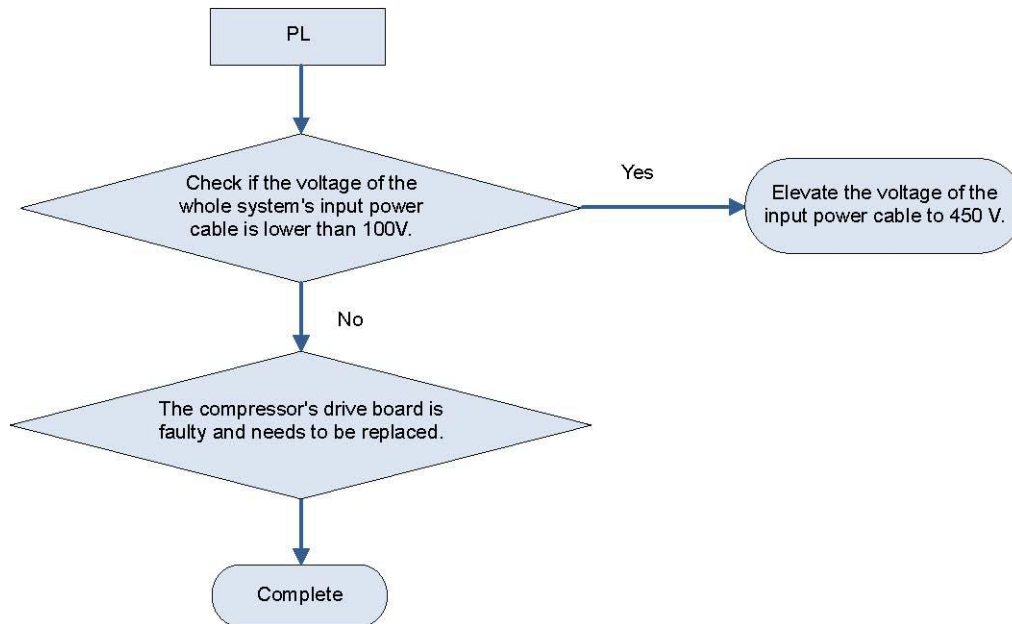

PART 3 KEY PARTS MAINTENANCE

1 CAUTIONS ON CONTROLLER REPLACEMENT

1.1 Cautions on IDU AP1 Replacement

Before replacing IDU AP1, determine the module is a master IDU or a slave IDU. For heat recovery VRF, there is no master IDU.

1.1.1 AP1 DIP setting and jumper cap confirmation

Whatever the AP1 you replace is a master IDU AP1 or a slave IDU AP1, after it is replaced, check original DIP setting and model.

Configure capacity DIP for the new AP1 and confirm its jumper cap, fan overload detect terminal, and overflow detect terminal. They should be kept identical to those of the faulty AP1.

Their positions and corresponding silkscreen are as follows:

Capacity DIP: S1 (Capacity)

Jumper cap: U22 (Jump)

Overflow detect terminal: CN35(WATER-DTCT)

Fan overload detect terminal: CN36(OVC-FAN)

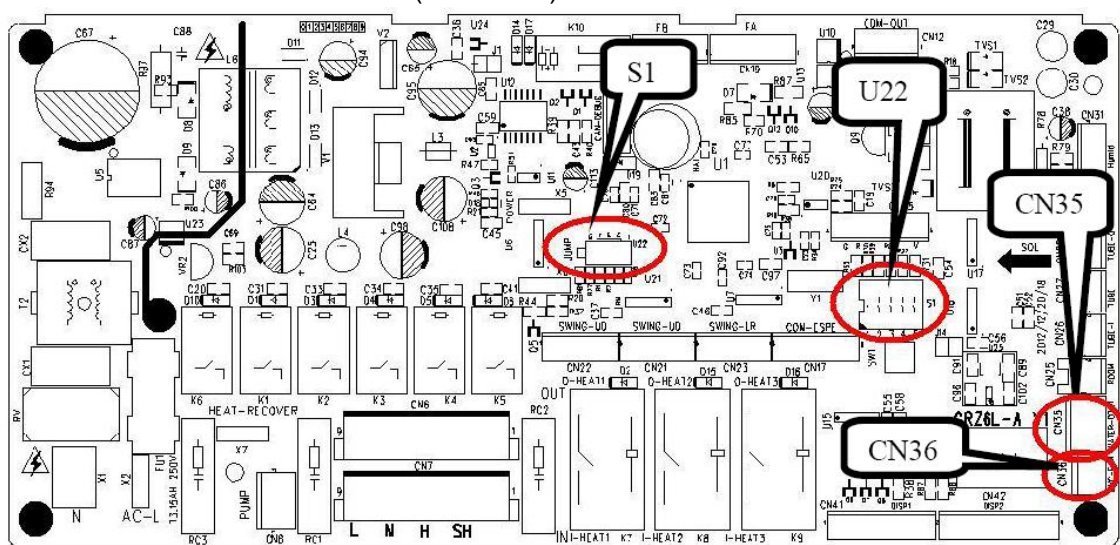

1.1.2 Restoring AP1 engineering parameters to factory settings (this step is not required for original packaged parts)

After wiring, whatever the AP1 is a master IDU AP1 or a slave IDU AP1, the new AP1 must be restored to factory settings. There are three methods to restore engineering parameter settings:

- (1) If the IDU is configured with wired control, set P35 and P36 to default values.
- (2) If the IDU is configured with wireless control, use the special control YV1L1 to set P35 and P36 to default values.
- (3) If the IDU is configured with wireless control and special control, you can restore engineering settings through the AP1 SW1 button. After AP1 is powered on, press and hold SW1 for 5 seconds. If a tick sound is heard, release the button.

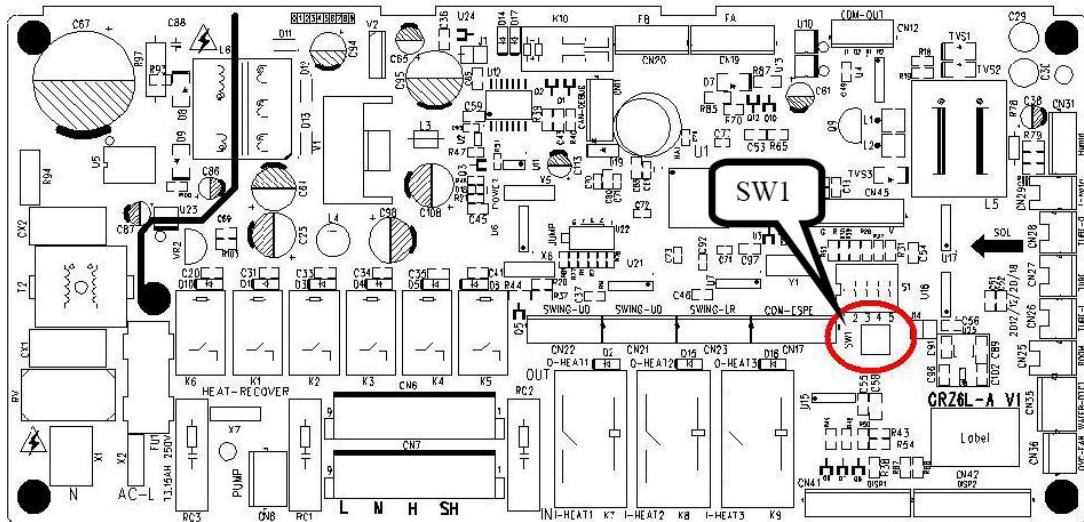

1.1.3 Cautions on replacement of master IDU AP1

If the AP1 of the master IDU needs to be replaced, after the IDU is powered on, “No master IDU (L7)” or “Project number conflict (C5)” alarm may be reported.

- (1) Troubleshoot for “no master IDU (L7)” fault



Method 1: If the IDU is configured with wired control, stop the IDU (except for lock mode) and press and hold the “MODE” button for 5 seconds to enter setting mode. After setting, the “Master” icon will be highlighted and the wired control buzzer will beep once.

Method 2: If the IDU is configured with lamp board or wired control, set to fan mode, 30°C/86°F, and press and hold “-” and “+” consecutively three times within 5 seconds. The IDU and wired control will identify it as a master IDU setting command, and show “set master IDU success (UC)” (5 seconds) and highlight the “Master” icon respectively.

Method 3: If the IDU is configured with the Debugger, set the IDU to master IDU through this software.

- (2) Troubleshoot for “project number conflict (C5)”



If this fault occurs, the number of the new AP1 is identical to that of a unit within the network. Manually change it to the original number of the faulty AP1 or a unique number. There are three methods to change project number:

- Method 1: If the IDU is configured with wired control, set P42 to a new project number.
- Method 2: If the IDU is configured with lamp board, use the special control YV1L1 to set P42 to a new

project number.

Method 3: If the IDU is configured with the Debugger, configure a new project number through this software.

TIP: If there are N units within the network, the units should be numbered from N+1.

Special situation:

In some cases, the created project number is identical to that of a unit within the network. In this case, you can use the —one-key IDU project number reset || function. However, this function will cause the project number of the entire system to be re-distributed; thus, original number will be changed. If you do not expect this result, forbid the use of this function and replace the AP1 again.

Methods to use the —one-key IDU project number reset || function:

Method 1: If the IDU is configured with wired control, set P45 to reset IDU project number through one key function.

Method 2: If the IDU is configured with lamp board, use the special control YV1L1 to set P45 and reset IDU project number through one key function.

Method 3: On the AP1 of the master ODU, press and hold SW5 for 10 seconds at least to clear all project numbers of the IDUs and then redistribute project numbers. Other parameters are kept unchanged.

▲ CAUTION

- After replacing the main board of master indoor unit, the master indoor unit must be reset.

1.1.4 Cautions on replacement of slave IDU AP1

If the AP1 of a slave IDU needs to be replaced, after it is powered on, “Project number conflict (C5)” alarm may be reported. Refer to section 2.3 “Cautions on Replacement of Master IDU AP1” to address the issue.

1.2 Cautions on Wired Control Replacement

1.2.1 Cautions on wired control XK46 replacement

- (1) If the wired control to be replaced controls only one IDU, directly replace the control.
- (2) If the wired control to be replaced controls multiple IDUs, perform the steps below first:

Set the wired control parameter —P14 || to change the number of managed IDUs to the actual quantity the control manages. For example, if the wired control manages 3 IDUs, set this parameter to 3. If you keep the default value 1, the LCD displays L9 (as shown in the figure below).

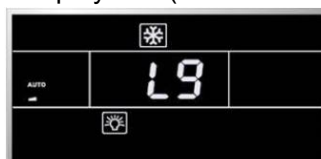

(3) If there are two wired controls controlling one or multiple IDUs, perform the steps below first:

Set the wired control parameter “P13” to change the address of one control to 01 (master) and that of the other control to 02 (slave); otherwise, a CP (multiple master wired controls) fault alarm will be reported (as shown in the figure below).



After setting, the LCD displays the  icon, as shown in the figure below.



NOTE: All wired controls are set to master wired controls by default.

(4) If the AP1 of the master IDU is replaced,

Reset the master IDU through the wired control; otherwise, the LCD displays L7 (no master IDU).

There are two methods to set the IDU:

1) In shut mode, press and hold the “MODE” button for 5 seconds and set the IDU corresponding to this wired control to a master IDU. After setting, the “Main” icon is highlighted.

2) Set the wired control parameter “P10” to 1.

1.2.2 Cautions on wired control XK79 replacement

To replace the wired control XK79, in addition to the preceding handling steps specific for XK46, you should also configure access control.

(1) If the wired control does not need an access control system, set switch “1” for DIP S1 at the bottom of the wired control to digital end (neglect switch “2”).

(2) If the wired control needs an access control system, set switch “1” for DIP S1 at the bottom of the wired control to ON (neglect switch “2”) and connect the access control card interface to ports N and L or ports VCC and GND of the wiring terminal. The following should be noted:

- 1) Ports N and L are power interfaces of 100-240V~50/60Hz access control.
- 2) Ports VCC and GND are power interfaces of DC 5-24V access control.
- 3) Either of them can be selected at one time.

2 COMPRESSOR REPLACEMENT AND CAUTIONS

2.1 Determining Compressor Fault

2.1.1 Precondition: units can be normally started.

Step 1: If units can be normally started, start the units so as to measure line current of the faulty compressor. Use a pressure gauge to measure pressure of various valves and connect the gauge to a PC for viewing test data. Verify the current data in the figures below against the current recommended.

For inverter compressors, current will be deviated 10% while rate of turn and operating condition vary.

(1) For inverter compressors QXAW-F518zX440B:

The figures below shows cooling capacity curves, and input power curves, and refrigerant flow rate curves, which are obtained in the testing condition that suction temperature is 35°C, and liquid subcooled temperature is 8.3°C, and ambient temperature is 35°C.

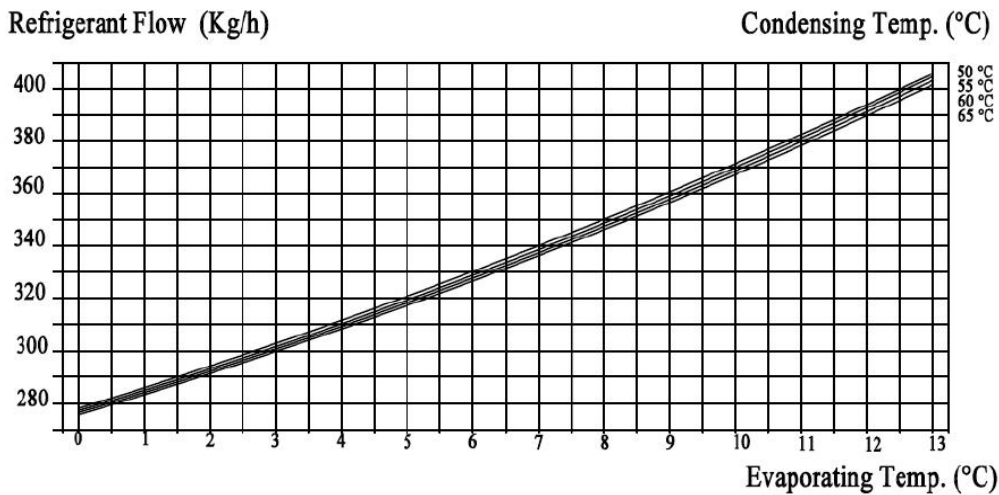
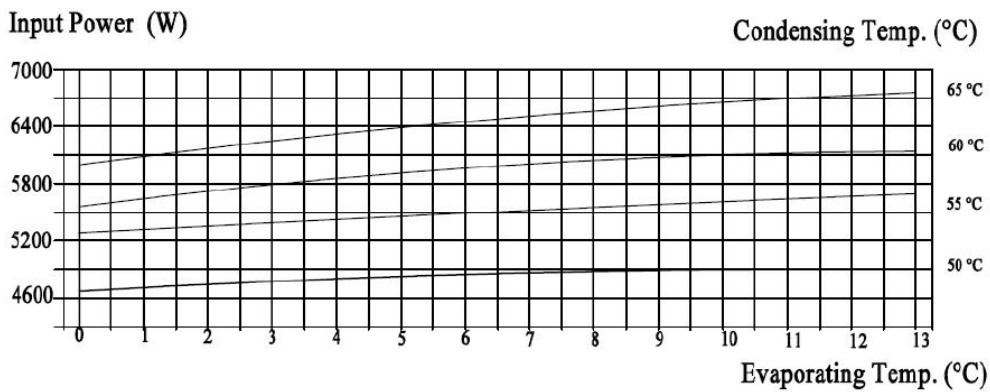
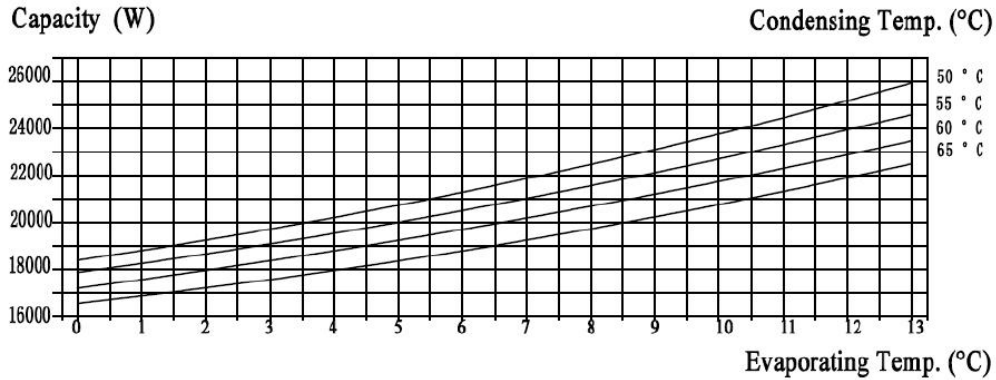

NOTE: You can infer from the preceding figures the current of the compressors operating at other frequency bands.

Step 2: Check whether the compressor sounds sharp or rubs. Compare the sound of the faulty compressor with that of normal ones.

Step 3: Check whether the electric expansion valves of ODUs and the 4-way valves act, and whether the oil return pipes and oil balance valves 1 and 2 are normal. Touch the pipelines next to the return capillary tubes to check whether there is oil flowing.

Check method for each part:

(1) Electric expansion valve: This valve will reset for each power-on or power-off action. Touch the valve and you will feel its vibration during the reset action. A crack sound will be heard as well.

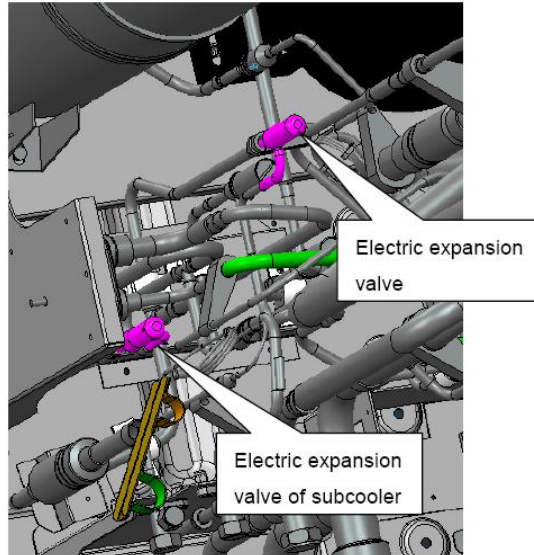

Description of electric expansion valve:

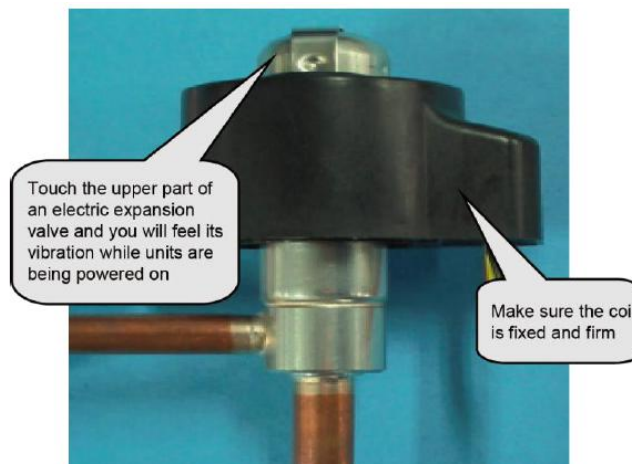

(2) Four-way valve: While this valve is normally running, the four copper pipes connected to it will suffer different temperature. When a unit switches to act the valve, you will feel obvious vibration and hear sound.

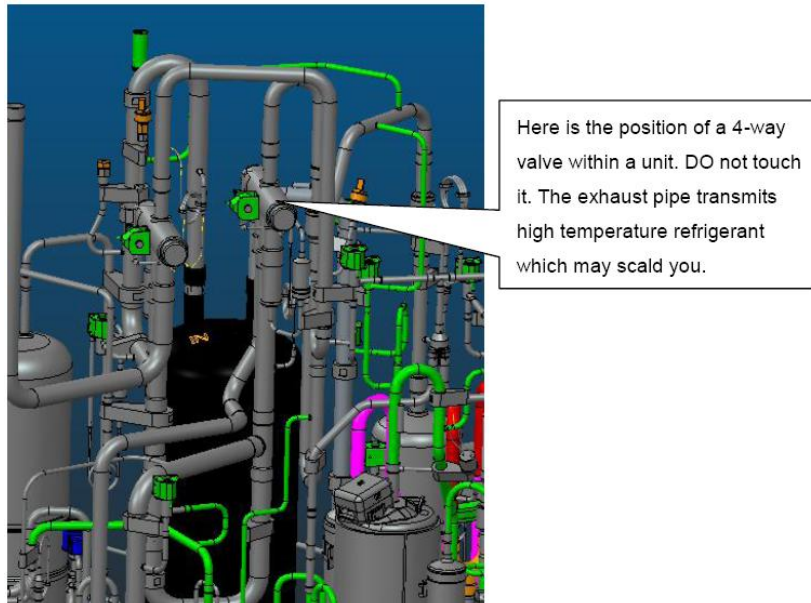

Labels on the 4-way valve and their meanings: D – connects to exhaust; E – connects to IDU evaporator; S – connects to intake of gas separator; C – connects to condenser. When the system is cooling, the pipe at side C works at high pressure high temperature, the pipes at sides E and S work at low pressure low temperature; when the system is heating, the pipe at side E works at high pressure high temperature, the pipes at sides C and S work at low pressure low temperature. The pipe at side D connects to exhaust and it is always working at high pressure high temperature. When units are starting, defrosting, or returning oil, the valve will vibrate obviously. DO NOT touch the pipe; or, you may be scalded.

(3) Oil solenoid valve: This valve can be operated based on its state that is shown through the monitoring software and actual situation. When this valve is opened, the coil will be heated and lubricant at both sides of the valve flows.

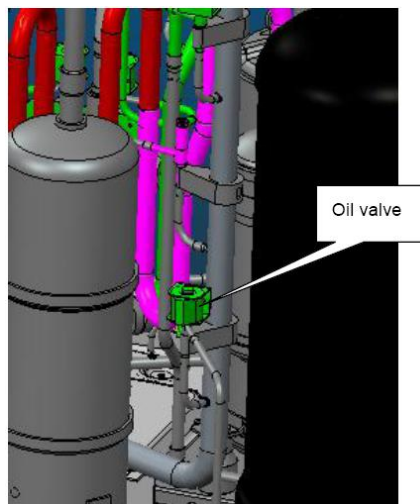

Step 4: Test the IPM module of compressor drive board and PFC board to see whether it is normal.

1) Disconnect the power supply. Five minutes later, remove the line of the faulty compressor.

2) Set a multimeter to gear diode.

For Drive board:

Use the black probe of the multi-meter to touch the place marked by P and the red probe to touch places marked by U, V and W respectively and record readings of the multi-meter. Use the red probe to touch the place marked by N and black probe to touch places marked by U, V and W respectively and record readings of the multi-meter.

For PFC board:

Use the black probe of the multi-meter to touch the place marked by P and the red probe to touch places marked by L1, L2 and L3 respectively and record readings of the multi-meter. Use the red probe to touch the place marked by N and black probe to touch places marked by L1, L2 and L3 respectively and record readings of the multi-meter.

3) Analyzing: If the reading ranges between 0.3 V and 0.7 V in the above-mentioned six scenarios, the IPM module is normal. If the reading is 0 in one or multiple scenarios, the IPM module is damaged.

2.1.2 Precondition: units cannot be normally started

Step 1: Disconnect the power supply of the units and open the electric junction box of the compressor to see whether wiring of the compressor is intact.

Step 2: Measure the resistance between two wiring terminals (U, V, W). The resistance value range should be 0.5~2.0 Ω .

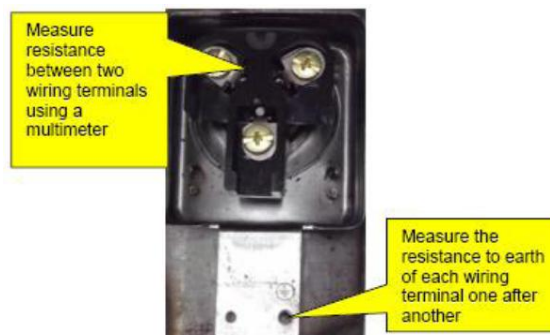

Measure the resistance to earth of each wiring terminal. The value should be 10 M Ω . If not, the compressor has an internal fault.

Step 3: Check the solenoid valves of the system, include electric expansion valves, oil return valves, and oil balance valves. Refer to the preceding section for the test method.

Step 4: Check the IPM module. Refer to the preceding section for the test method

2.2 Compressor Replacement

Step 1: Disconnect power supply.

Turn off the power switch of the ODUs and disconnect the line of the power supply and the power line of the ODUs. Meanwhile, cover the power line with tape for insulation and put a warning sign beside the power switch to prevent electric shock.

Step 2: Clear electric parts (do not need to disassemble the electric box).

Before removing compressors' lines, temperature sensors, and electric heaters, mark them so that

you will reconnect them in a correct manner after clearing. The removed electric box must be covered and protected from wind and sun.

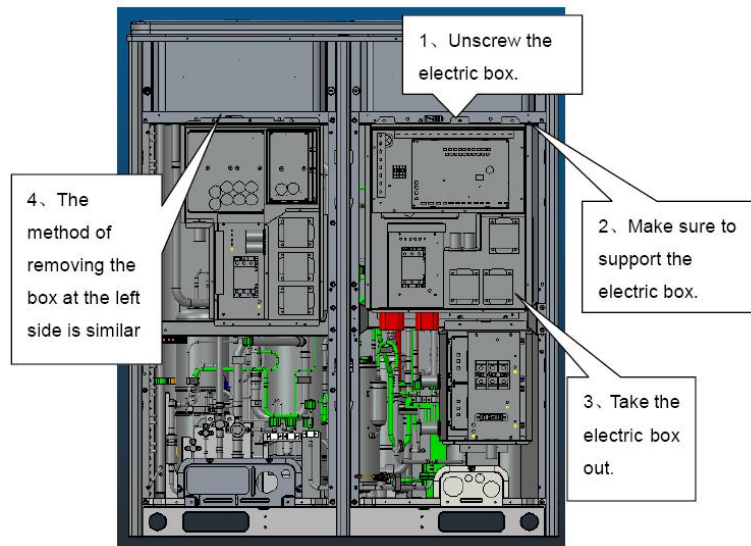

After the box is removed, take care with the removal of electric parts' lines. DO NOT pull the lines with excessive force; or they may be broken. The removed electric box must be protected for dustproof and waterproof purposes.

Step 3: Release refrigerant.

Refrigerant should be released from the high pressure side and low pressure side at the same time. If it is released from one side only, the scroll is sealed, causing the refrigerant to fail to be released completely. Control the release speed (it is expected to release for 12 hours or more). If too fast, massive lubricant will be discharged with the refrigerant. Make sure to mark the valves. At the low pressure side, refrigerant is released through the low pressure check valve.

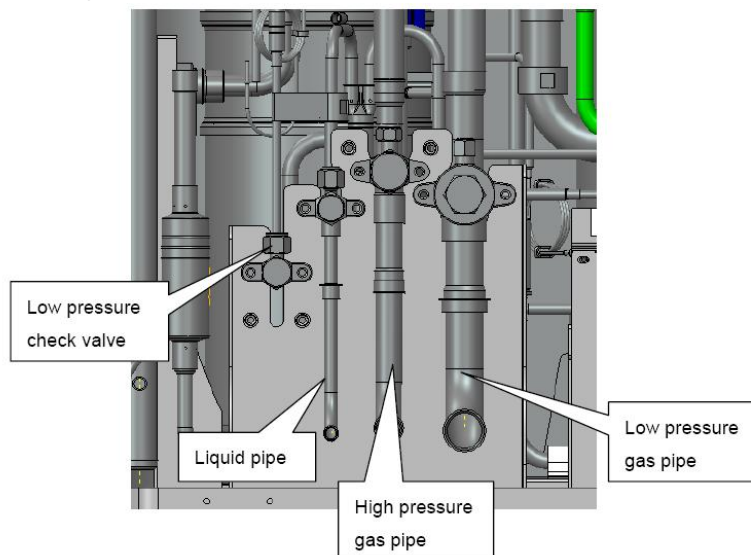

Step 4: Remove faulty compressors.

Confirm faulty compressors, including number of faulty ones, compressor position, and model.

Handling procedure varies with compressor model.

(1) Inverter compressors and oil quality

If the inverter compressor is damaged, remove the inverter compressor. The procedure is as follows:

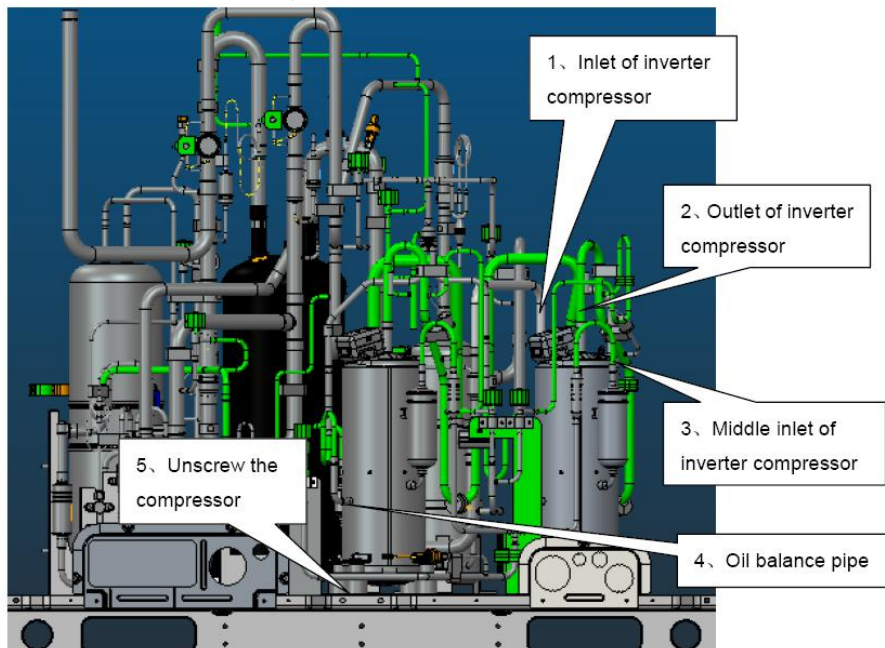

After the compressor and oil separator are removed, check oil quality. If oils are contaminated, replace the compressor, oil separator, and gas/liquid separator. If oil changes to black, check oils of other modular units. The check procedure is similar to the preceding.

Note: Before replacing the faulty compressors, make sure to block their openings with tapes. They should be kept intact for further analysis.

Step 5: Check system parts.

If system oil is contaminated, check unit parts, including oil separator, gas/liquid separator, and storage tank.

(1) Check oil separator.

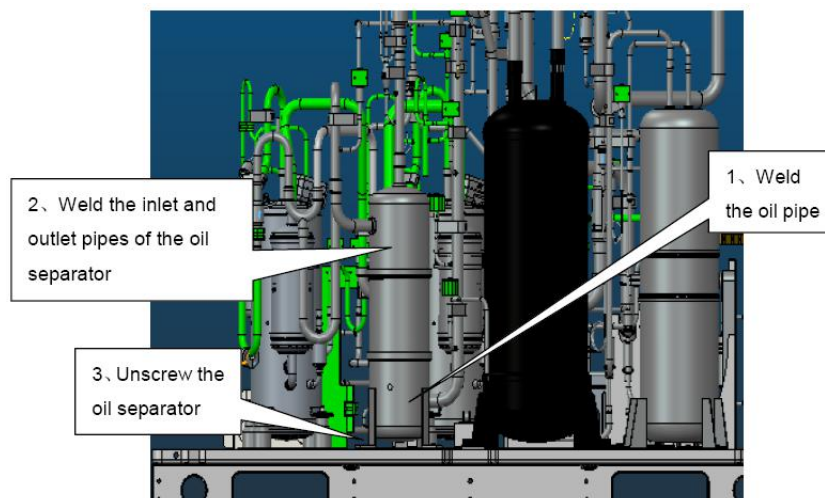

Remove the oil separator. For the removal procedure, refer to step 4. Tilt the separator to draw oil out

into a container. Block the container for further factory inspection.

(2) Check gas/liquid separator.

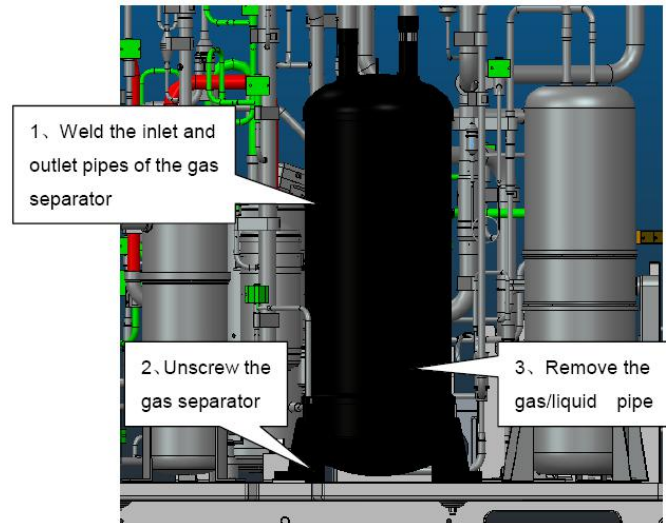

After the gas/liquid separator is taken out, check whether it contains impurities. The check procedure is as follows:

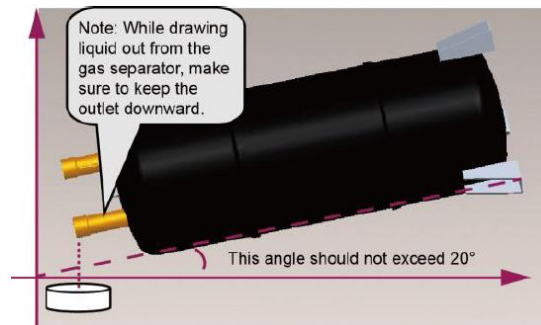

Use a glass container to hold the liquid. Check liquid impurities and colors and block the container for further factory inspection.

Note: If the compressor needs replacement, the gas/liquid separator needs replacement as well, regardless whether the separator contains impurities or has faults or not.

(3) Check oil return pipe and oil balance pipe.

Remove oil return pipe and oil balance pipe, and check oil volume and impurity.

Note: Before replacing the faulty parts, make sure to block their openings with tapes. They should be kept intact for further analysis. Volumes of oils drawn out from the oil separator, and gas/liquid separator should be recorded. After faulty compressors and parts are replaced, you should fill new oils of equivalent amount into the compressors and parts.

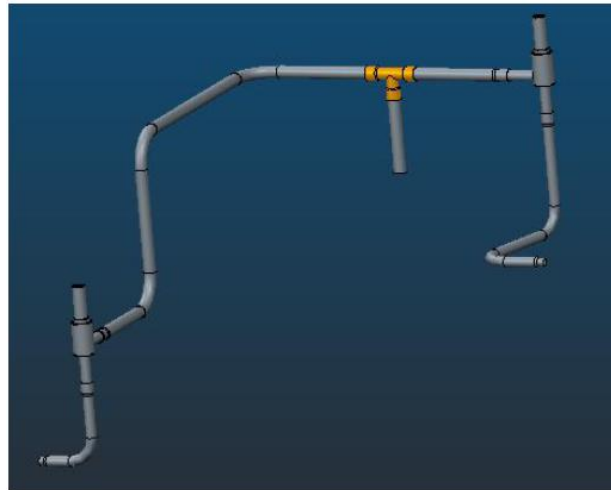

Oil balance pipe

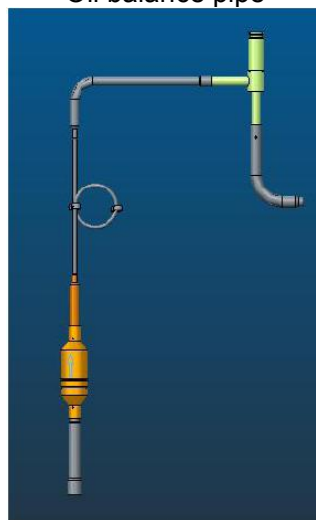

Oil return pipe

Step 6: Clear pipeline system.

Check pipelines for abnormalities. Charge nitrogen into the main pipeline and clear the pipeline system.

(1) Clear oil balance pipe.

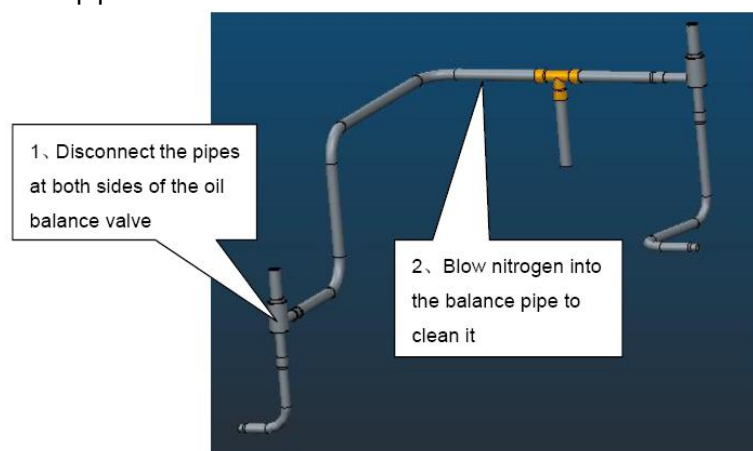

(2) Clear oil return pipe.

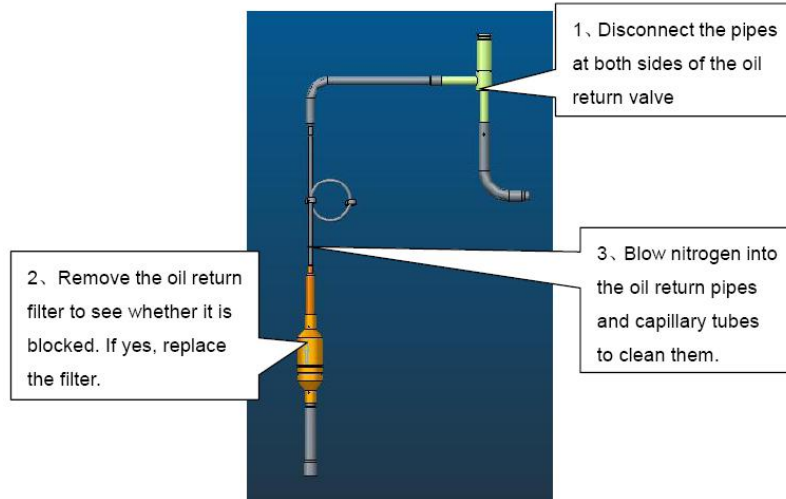

(3) Clear liquid pipe filters.

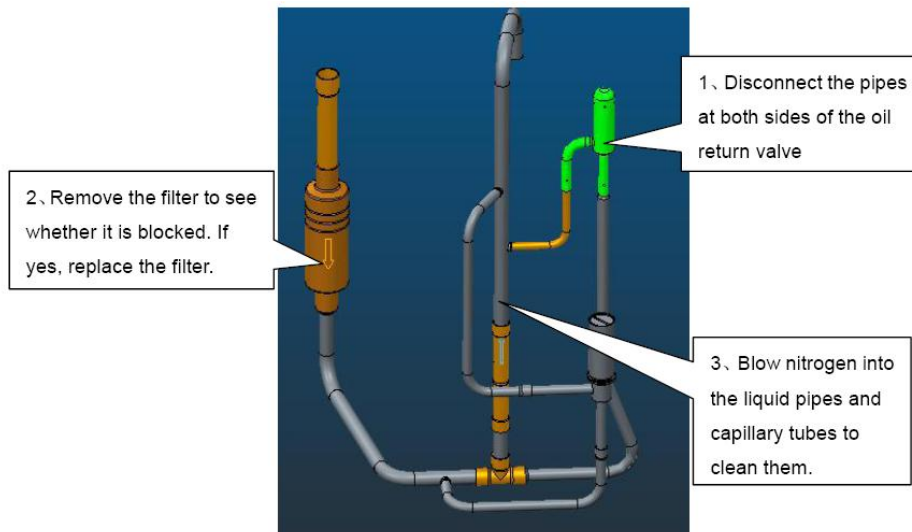

For other pipeline parts, clear them based on actual situation. If you do not replace the parts immediately, make sure to block the pipes with tapes, preventing air moistures and impurities from contaminating them.

Step 7: Preparations.

(1) Prepare new parts.

In the course of moving compressors, do not lay them down or put them upside down. The tilt angle should be less than 30°. Make sure oil will not overflow from the oil balance opening. The inlet and outlet should be blocked. If the sealing rubber is not available, cover them with tape to prevent direct contact of oil and air.

Note: The new compressor must be consistent with the faulty one in model.

Check the rubbers for oil separator, gas separator, and drying filter. If they are lost during transportation, cover the parts with tape to keep the compressor dry and airtight inside.



Note: Compressor lubricant must be kept completely airtight. GREE compressors use special lubricant FV50S whose moisture absorption capability is high. Requirements on air-tightness of these compressors are higher.

(2) Prepare other materials.

1) Prepare enough nitrogen. They will be used during welding. Nitrogen pressure should be 2.0 MPa at least.

2) Prepare welding rods. In addition to ordinary welding rods, you should also prepare special welding rods (containing 5% or more silver). Compressors inlets and outlets are made of copper plated steels, which require special welding rods and materials.

3) Prepare gases for welding. Oxygen and acetylene of proper amount should be determined with consideration of actual welding positions. Try to finish the welding task once. Avoid repeated welding.

4) Prepare tools, including hexagon, diagonal pliers, combination pliers, needle nose pliers, multimeter, pressure gauge, Phillips screwdriver, flathead screwdriver, wrenches (at least two), PVC insulation tape, and tielines (multiple).

Step 8: Install a new gas/liquid separator.

Note: If a faulty compressor needs replacement, the gas/liquid separator needs replacement as well. This is to avoid abnormality from happening inside the gas/liquid separator, and affecting system safety and reliability.

Put the gas/liquid separator on a chassis and connect the inlet pipe of the gas/liquid separator with the outlet pipe. Then, connect the pipe to a nitrogen source. The nitrogen source can be connected based on actual situation, for example, you can add a bypass interface or directly connect the nitrogen source to the inlet/outlet pipe. If the pipe is big, cover it with tape as well. Make sure nitrogen can smoothly flow through the gas separator.

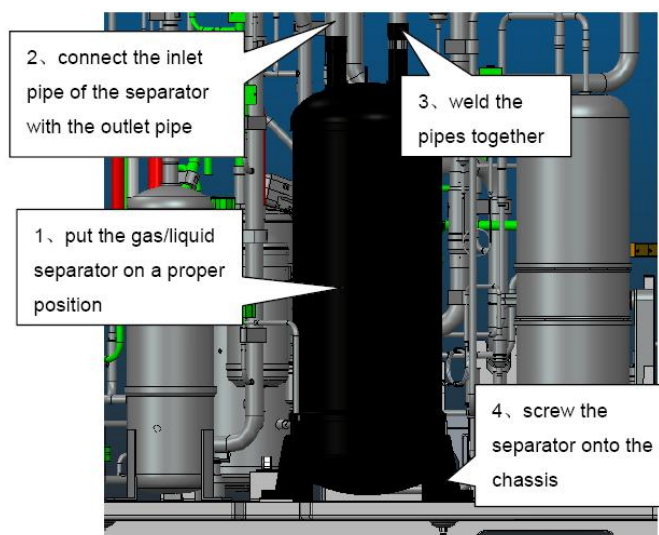

Step 9: Install a new oil separator.

The original oil separator, if it is found to have no impurities or other objects, can be used further more. This part serves as a container and it does not have complex structure. However, if it contains impurities or other objects, replace it. This is because a dirty oil separator cannot be thoroughly cleaned.

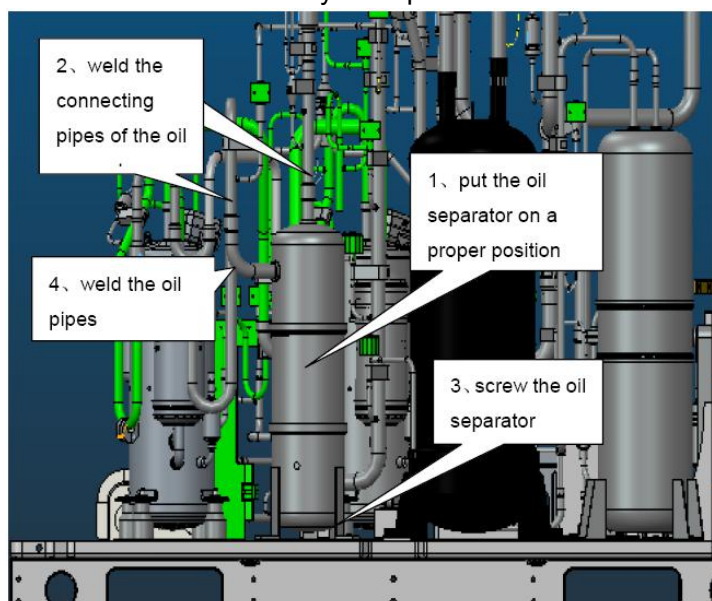

Step 10: Install a new compressor.

If it is a inverter compressor that needs replacement

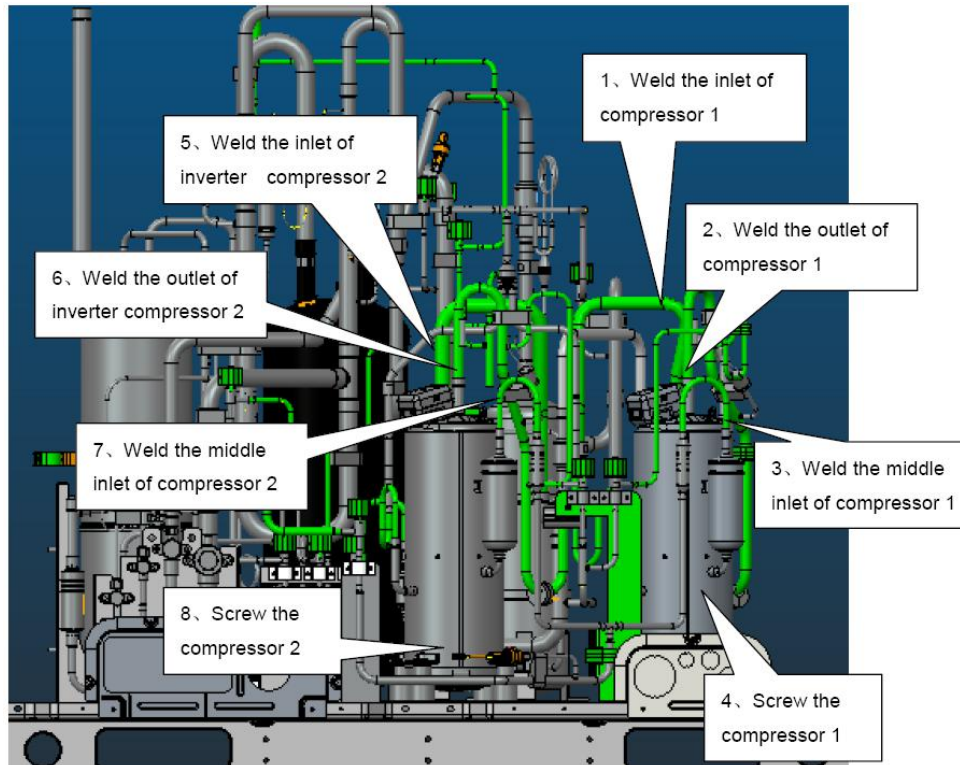

Note: Keep wiring identical to factory installation. Control varies with compressors. Wrong wiring or inverse connection of the compressors may cause damage to units.

Cautions on replacement of compressors:

① Before installing new compressors, remove the sealing rubbers and weld the compressors with corresponding pipes. During welding, charge nitrogen into the pipes. Since compressors' suction and discharge pipes are made of copper plated steels, you need to prepare special welding rods (containing 5% or more silver). Welding clearance should be controlled within 0.1~0.3mm (0.0039inch~0.0118inch), avoiding blockage or loose welding. During welding, control pipe openings from being over-heated.

② After the pipeline system is welded, use special supports and bolts to fix the compressors, ensuring stability of the compressors during running.

③ Power lines of the compressors should be wired following the factory installation. You can refer to the wiring diagram. Phase sequence error and inverse connection of compressors are not allowed. In particular, if there are two inverter compressors that need replacement, pay attention to wiring. Control varies with compressors. Inverse connection of the compressors may cause damage to units.

Step 11: System check.

(1) Check welding joints for abnormalities.

(2) Charge nitrogen into the system for leakage detection. If you are maintaining ODU and the IDU system is normal, you can charge nitrogen into the ODU system only. Note that nitrogen should be charged from both the high pressure side and low pressure side. You are advised to charge through all valves. Nitrogen pressure should be larger than 20 kgf. Then, charge soapsuds into the system and check specially the weld joints for leakage.

(3) Finally, charge nitrogen into the system again for pressure check. Close all valves and keep

system pressure up to 25 kgf for more than 12 hours. If the pressure remains unchanged, you can extract all air. Otherwise, you should find the leakage points first.

While determining system pressure change, take temperature into consideration. For 1°C temperature change, pressure will change by 0.01MPa (1.45PSIG) accordingly. Suppose that nitrogen pressure reaches 2.5MPa(363PSIG) at 30°C(86°F), 12 hours later, temperature decreases to 25°C(77°F) and pressure decreases to 2.43MPa(352PSIG) accordingly. The system is regarded qualified despite the pressure decrease.

Step 12: Fill lubricant.

Quantity of lubricant that is needed is subject to the total draw amount from compressors and parts. The fill amount should be equivalent to the draw amount. If the draw amount is too little or too much, clear all lubricant first and determine fill amount.

Fill amount is determined by two factors: the number of compressors replaced and the draw amount from each part. For replacement of one compressor, 1.35 L lubricant should be added. The fill amount should be equal to or a little larger than the draw amount.

Examples:

One compressor is replaced; lubricant that is drawn from the gas separator is 1L and lubricant that is drawn from the oil separator is 0.7L. Then, the total required amount is $1.35L+1L+0.7L=3.05L$. You should add 3.05L lubricant into the system.

Specific procedure is as follows:

- (1) Ultra Heat GMV series units use FV50S lubricant. Make sure to confirm the trademark of the lubricant first. Lubricant of other trademarks is not allowed.
- (2) Open all valves and extract air for 30 minutes or longer.
- (3) Connect a rubber hose to the low-pressure measurement valve at one end. Open the container that holds lubricant and pour lubricant into a measuring glass. If the glass is too small to hold the lubricant of a required amount, measure the lubricant portion by portion. Record volume of each portion and then put the other end of the rubber hose into the glass.
- (4) Keep on extracting air and open the low-pressure measurement valve. The lubricant will be pressed into the low pressure side of units.
- (5) If the lubricant is added portion by portion, close the low-pressure measurement valve first and then measure another portion of lubricant. In the course of repeated measuring and adding, keep the extraction action.
- (6) After a required amount of lubricant is added, close the oil checking valve to ensure tightness.

Note: Lubricant is of great importance to the normal running of compressors. You should follow Gree's requirement to add qualified lubricant of the specified trademark and ensure properness of fill amount.

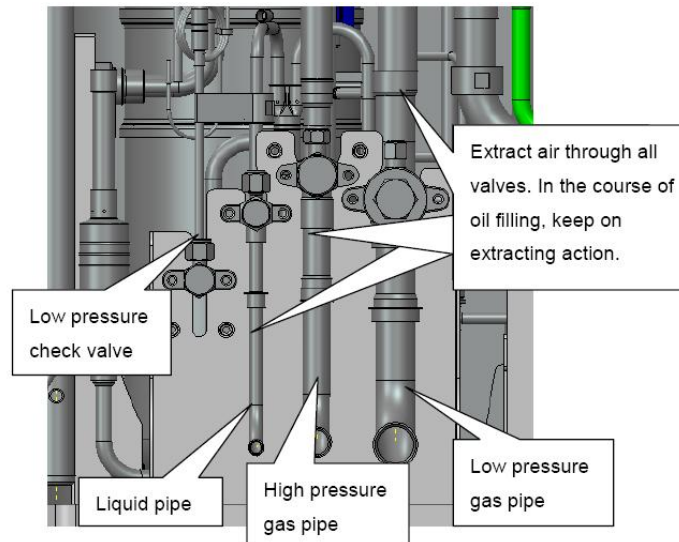

Step 13: Vacuum-pump.

After lubricant is added, keep on extracting air through a vacuum pump till the internal pressure reaches the absolute pressure 0kgf/cm² and the pressure gauge reads -1 kgf/cm². This is to ensure that moistures inside the pipeline system are completely vaporized.

Vacuum pumps of the specifications below are recommended:

Type	Max. Discharge Rate	Purpose	
		For air discharge	For vacuum drying
Lubricant driven pump	100L/min	Applicable	Applicable
Lubricant free pump	50L/min	Applicable	Applicable

Open all valves in order that the vacuum pump extracts air through all the valves, during which, connect the units to a pressure gauge. When the internal pressure reaches 0kgf/cm² and the pressure gauge reads -1kgf/cm², keep on the extraction action for 0.5~1.0 hour more. Finally, turn off the rotary switch of the gauge and close the pump. One hour later, if the pressure remains the same, fill refrigerant. If the pressure increases to 0.1kgf/cm² or higher, conduct leakage check again.

Step 14: Fill refrigerant.

Before filling refrigerant, check its manufacturer, package, and print information. Besides, check refrigerant pressure and quality against the saturation pressure / temperature list.

(1) Measure and check the pressure of the entire refrigerant product against the saturation pressure / temperature list. Verify temperature parameter. If the difference between the actual temperature and the parameter value is 3°C (37.4°F) or more, the refrigerant quality is unsatisfactory.

(2) If the refrigerant is proved satisfactory, fill refrigerant of the combined amount of the rated amount (specified on the nameplate) and the calculated refrigerant loss amount.

(3) For a multi-modular unit system, if only the refrigerant of an ODU is drawn out, add 80% refrigerant of the rated fill amount (specified on the nameplate of the ODU) and start the system for a debugging test.

Step 15: Install electric parts.

Install the electric box and connect various parts to the electric box by referring to the marks made beforehand and the wiring diagram on the back of the box. Wire the compressors and corresponding electric heating belts.

Note: Wires should be checked against the wiring diagram beforehand so that they can be connected correctly.

Step 16: Start for debugging.

Start the units and set them to run in refrigerating full-start, refrigerating single-start, heating full-start, and heating single-start modes respectively. Duration for each running mode should be 30 minutes at least. After the debug, analyze data and adjust the unit system, to ensure indexes of the entire system. For details about each index, please consult after-sale persons and technicians.

3 CAUTIONS ON COMPRESSOR DRIVE BOARD AND PFC BOARD REPLACEMENT

(1) Disconnect the power supply of the system. Set a multimeter to the AC voltage gear and measure voltage between two of the lines (L1, L2, L3, and N). The measuring result should be 0 V (sometimes, multimeters may be faulty and read false values). Set a mark beside the power supply for warning.

(2) Measure compressor drive DC bus voltage between two wire terminals of P, U, V, W and N. Set the multimeter to the DC voltage gear and measure the voltage between P and N. The voltage should be lower than 36 V. If no multimeter is available, wait for 20 minutes before performing the steps below.

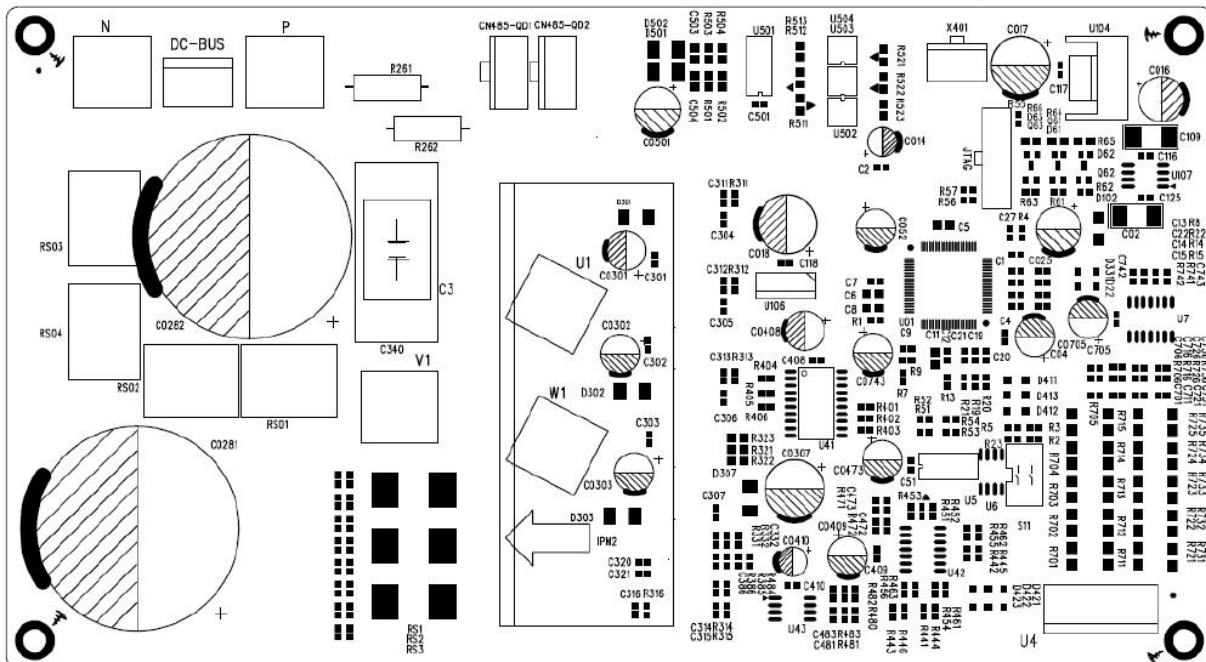

PFC board

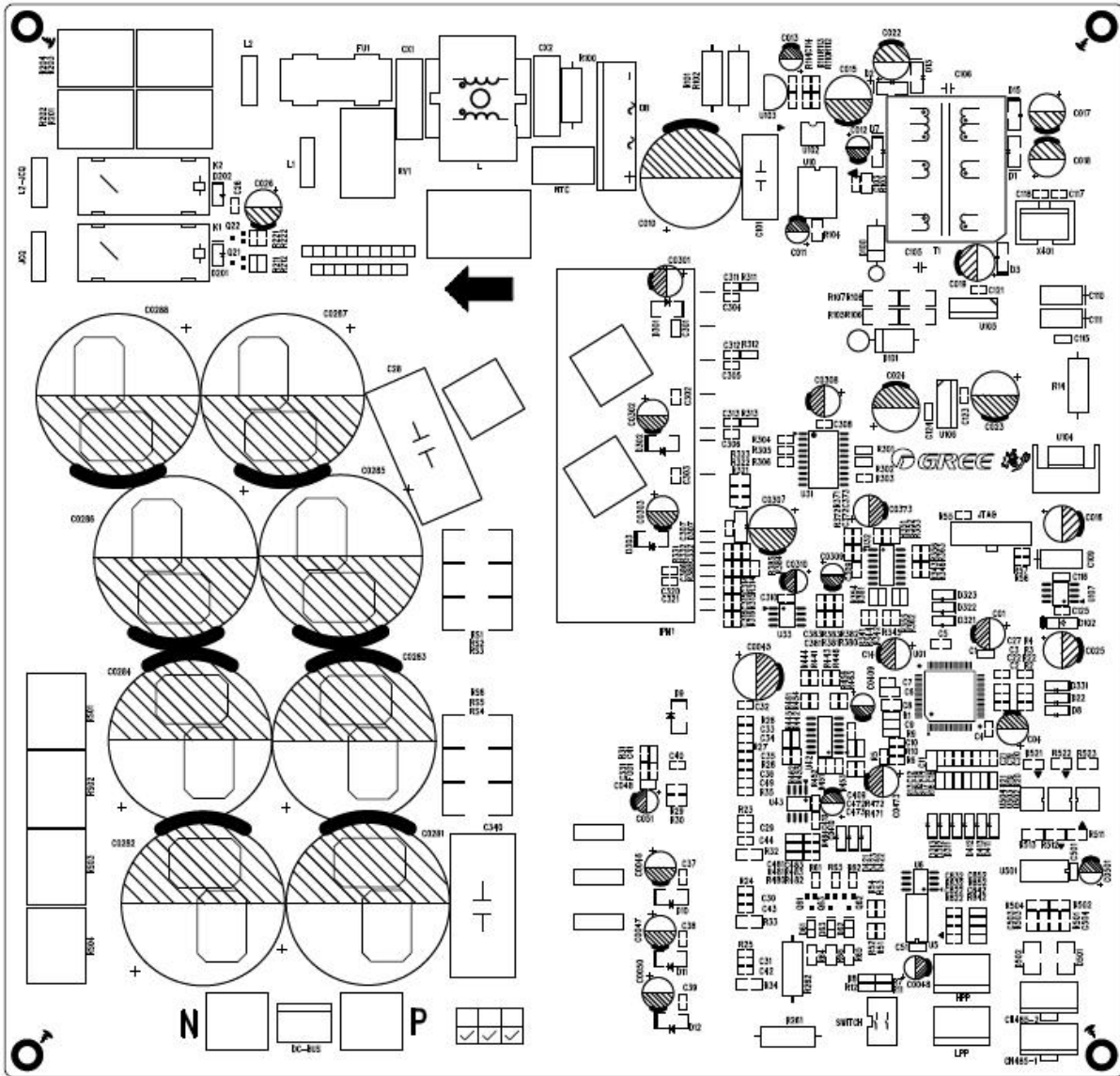

Drive board

(3) Disconnect all lines of the PFC board, including: communication line between the PFC and the drive; output 18 and 7.5 VDC connecting with compressor drive board; anode P; cathode N; output 450 VDC; reactor's wiring terminal; input AC power L1/L2/L3.

Disconnect all lines of the drive board, including: compressor line; communication line between the master unit and the drive; communication line between the drive and the PFC ; output 18 and 7.5 VDC connecting with compressor PFC board; anode P; cathode N; output 450 VDC; AC contactor driver; input AC contactor power L2; input AC power L1/L2. See the figure below:

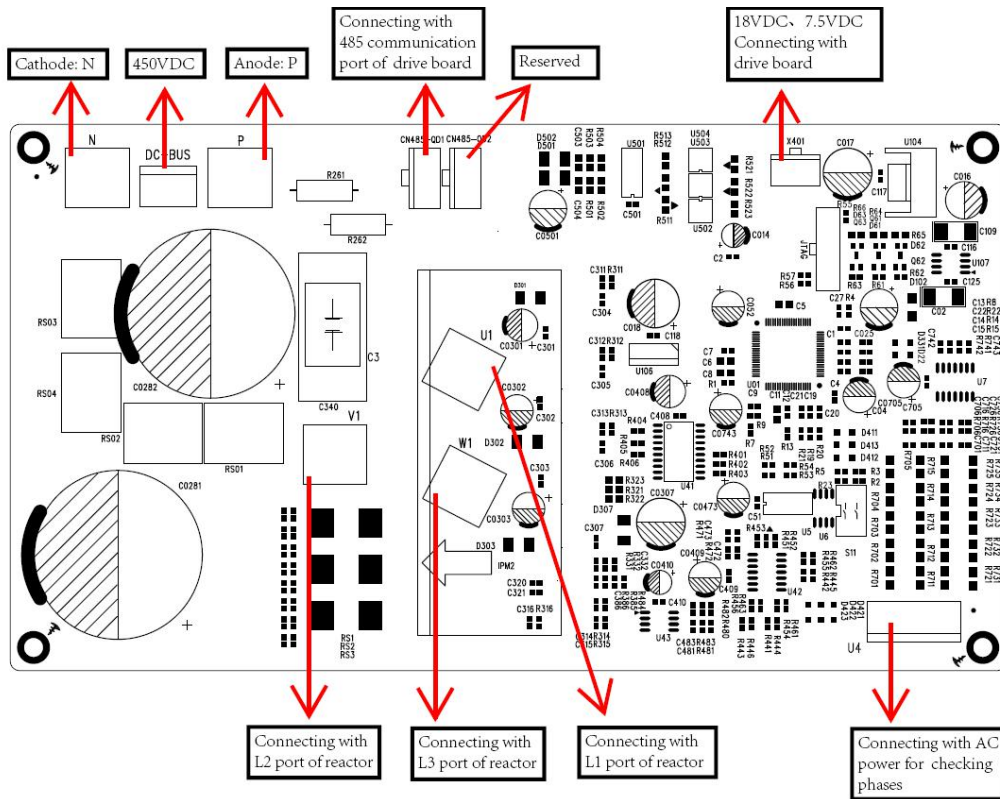

PFC board

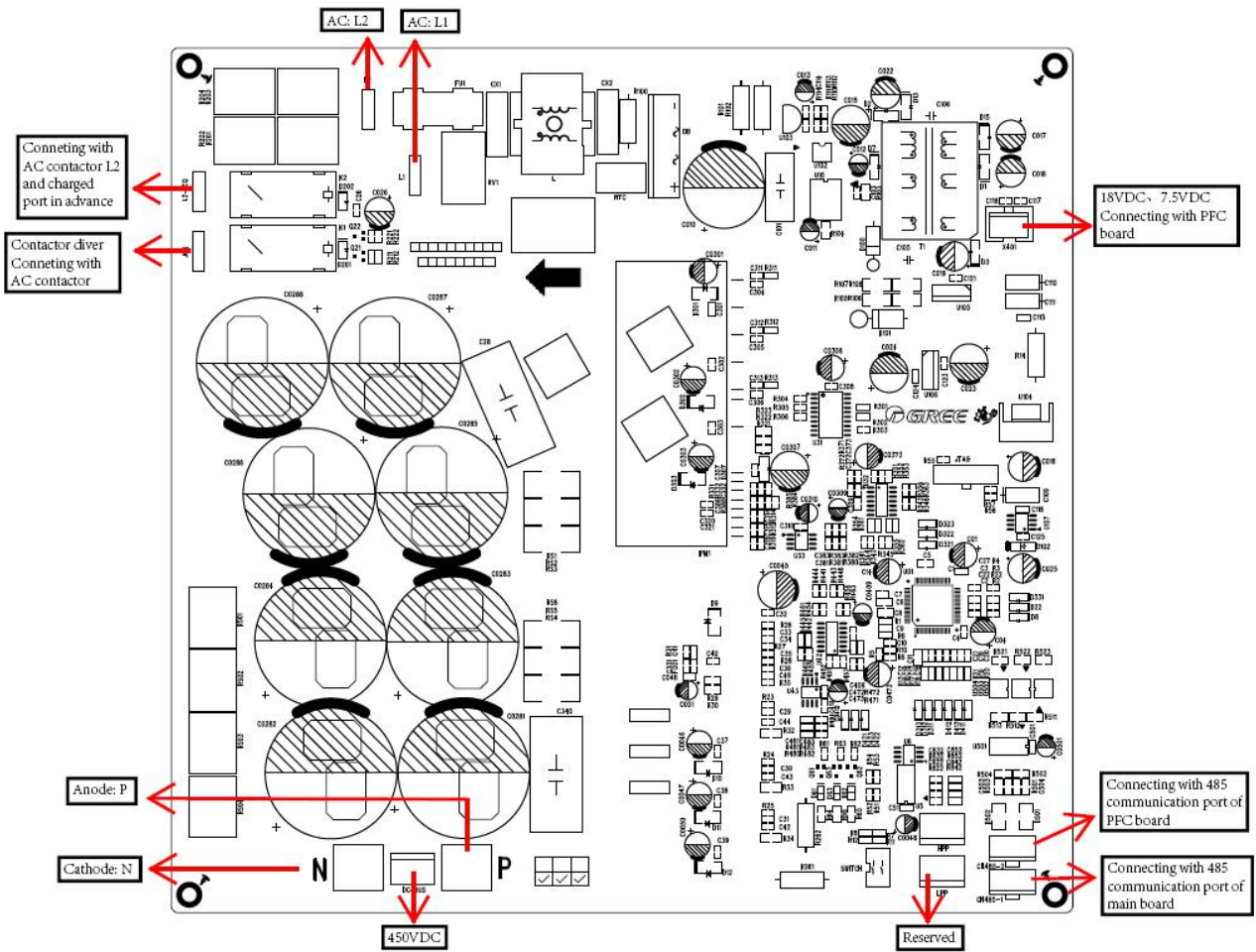

Drive board

(5) Replace the compressor drive board and PFC board. Before the replacement, apply some silicone tape onto the IPM module.

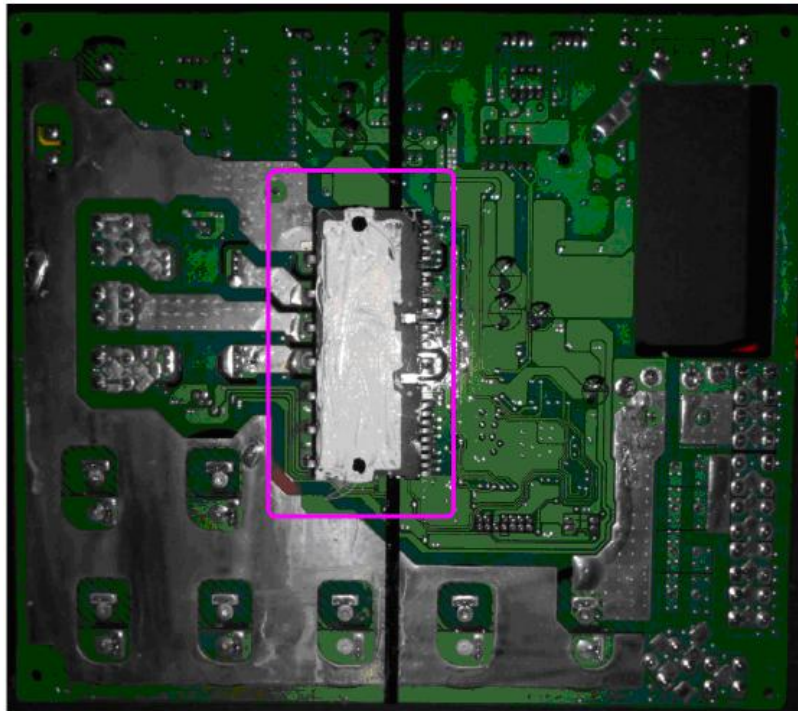

(6) Install a new compressor drive, screw and wire it.

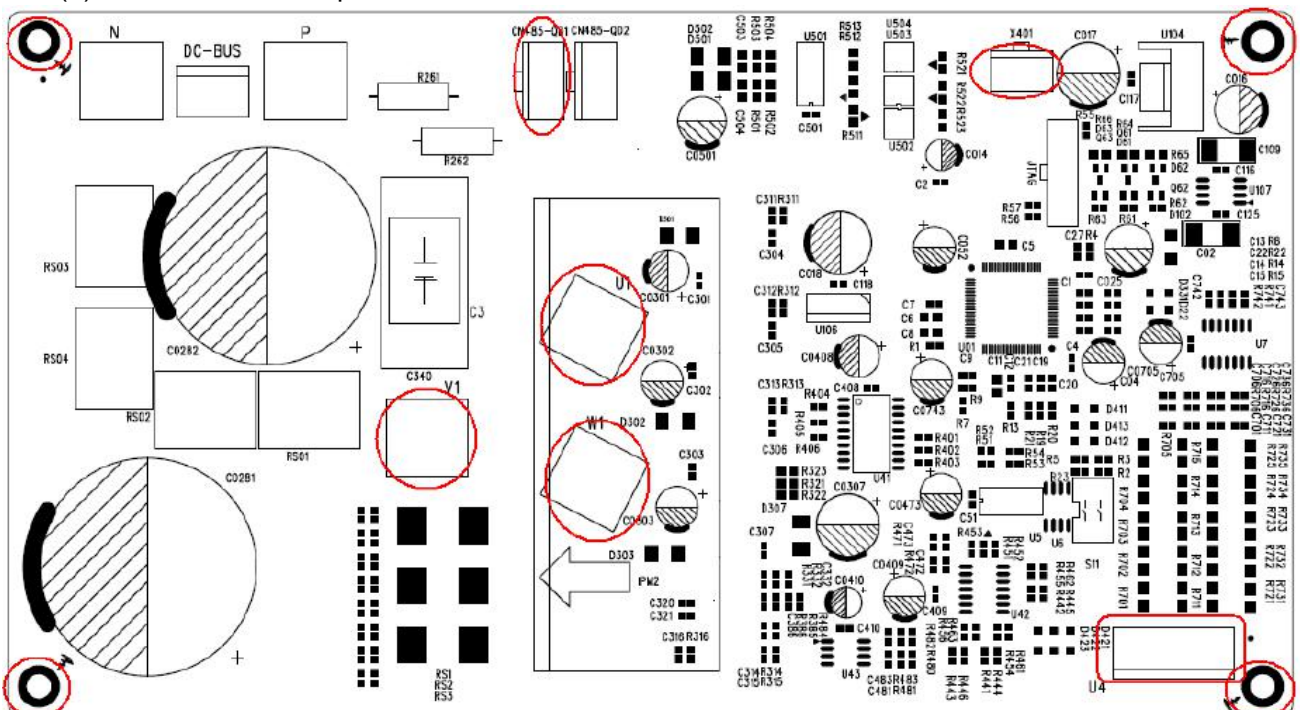

PFC board

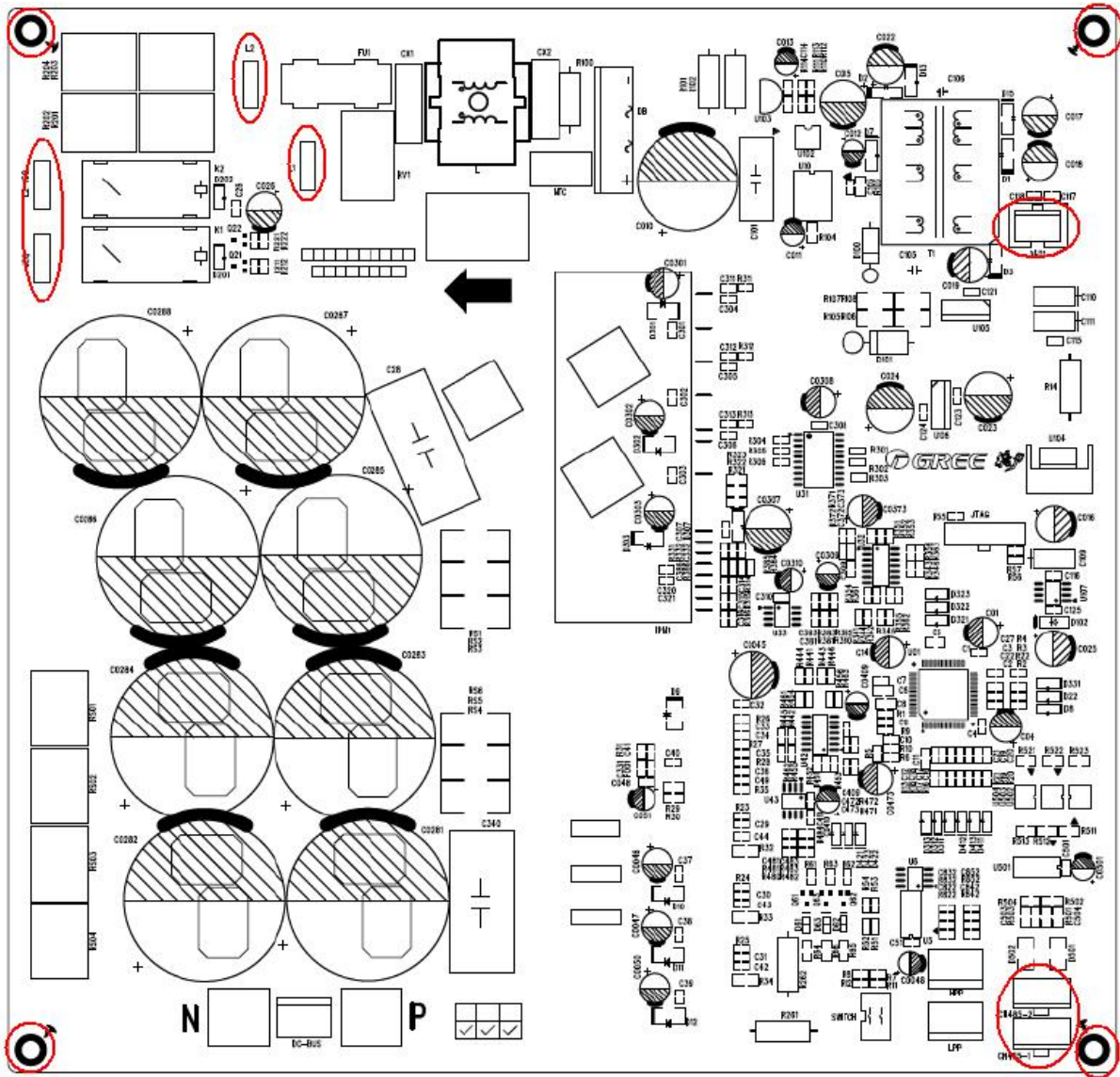

Drive board

4 ASSEMBLING AND DISASSEMBLING KEY PARTS OF ODUS

Compressor		
Precondition: No refrigerant exists in the pipeline system and the power supply has been disconnected		
Step	Diagram	Operation Procedure
1. Remove the front panels.		<ul style="list-style-type: none"> ● Use a screwdriver to unscrew the upper and lower front panels. ● Lift the front panels in order to take it out. <p>Note: Both the upper panel and lower panel are fixed with two fasteners respectively to connect to the side panels.</p>

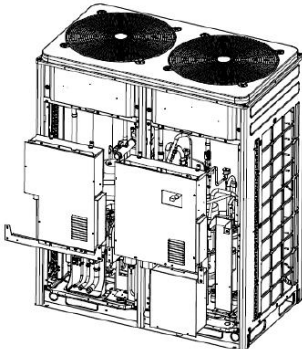
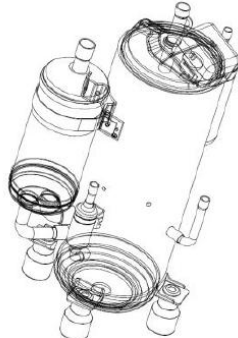
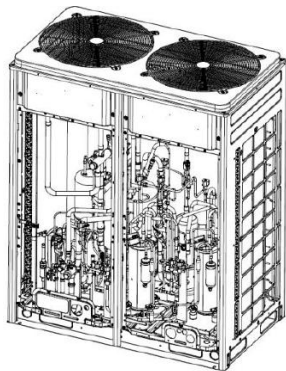
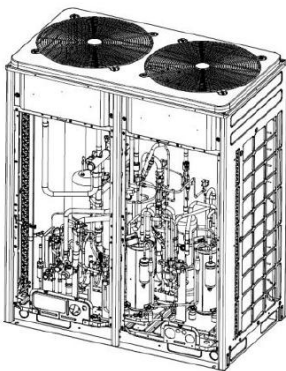
<p>2. Remove the electric box.</p>		<ul style="list-style-type: none"> ●Disconnect internal and external connecting lines of the electric box. ●Protect the internal parts during the disassembly.
<p>3. Disconnect the power line of the compressor, and remove the electric heating belt, top temperature sensor, and discharge air temperature sensor.</p>		<ul style="list-style-type: none"> ●Remove the sound-proof sponge from the compressor. ●Use a screwdriver to unscrew the power line. ●Remove the power line. ●Remove the electric heating belt and discharge air temperature sensor. <p>Note: Before removing the power line, mark the colors of the line and corresponding wiring terminals.</p>
<p>4. Loosen the nuts of the compressor.</p>		<ul style="list-style-type: none"> ●Use a wrench to unscrew the four nuts.
<p>5. Remove the suction and discharge pipes.</p>		<ul style="list-style-type: none"> ●Heat the suction and discharge pipes by acetylene welding and then remove the pipes. ●During welding, charge nitrogen into the pipes. The pressure should be controlled within 0.5 ± 0.1 kgf/cm² (relative pressure). ●Avoid nearby materials from being burnt during welding.

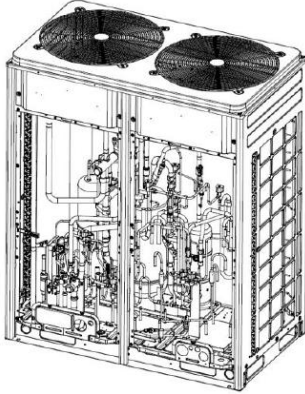
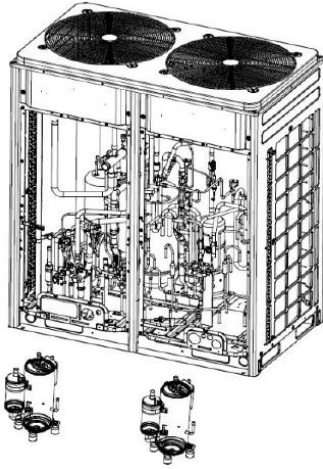
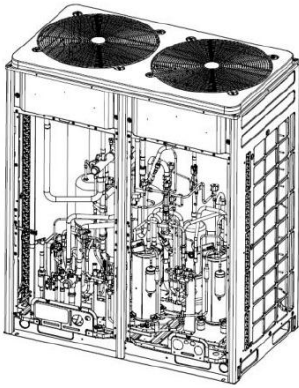
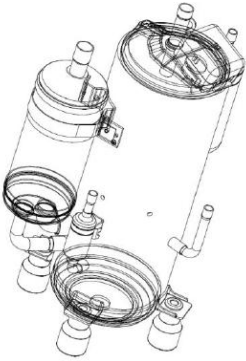
<p>6. Remove the compressor.</p>		<ul style="list-style-type: none"> ●Remove the compressor from the chassis.
<p>7. Install a new compressor on the chassis.</p>		<ul style="list-style-type: none"> ●Put the compressor in a proper position. ●Use a wrench to screw the nuts on the compressor. ●The compressor should not be installed upside down.
<p>8. Connect the suction and discharge pipes of the compressor to the pipeline system.</p>		<ul style="list-style-type: none"> ●Heat the suction and discharge pipes by acetylene welding and then install the pipes. ●During welding, charge nitrogen into the pipes. The pressure should be controlled within 0.5 ± 0.1 kgf/cm² (relative pressure). ●Avoid nearby materials from being burnt during welding.
<p>9. Connect the power line to the compressor, and install the electric heating belt and discharge air temperature sensor.</p>		<ul style="list-style-type: none"> ●Put the power line in a proper position. ●Use a screwdriver to screw the power line. ●Install the electric heating belt and discharge air temperature sensor. ●Put the sound-proof sponge back to position.

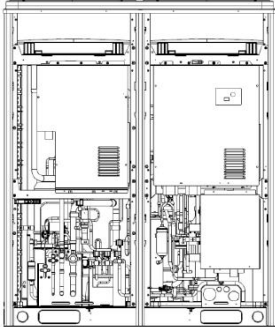
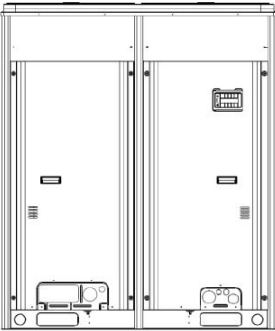
<p>10. Fix and wire the electric box.</p>		<ul style="list-style-type: none"> ●Put the electric box back to original position and screw it. ●Connect all lines.
<p>11. Check and then install the front panels.</p>		<ul style="list-style-type: none"> ●Check various parts and connecting lines. ●If no problem is found, hook the front panels and tighten the screws.

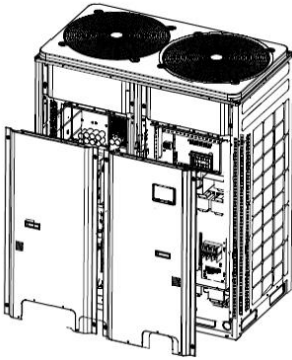
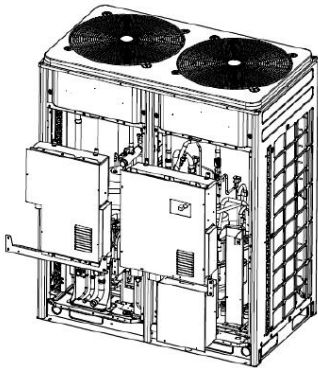
<p style="text-align: center;">Four-way valve</p>		
<p style="text-align: center;">Precondition: No refrigerant exists in the pipeline system and the power supply has been disconnected</p>		
<p style="text-align: center;">Step</p>	<p style="text-align: center;">Diagram</p>	<p style="text-align: center;">Operation Procedure</p>
<p>1. Remove the front panels.</p>		<ul style="list-style-type: none"> ●Use a screwdriver to unscrew the upper and lower front panels. ●Lift the front panels in order to take it out. <p>Note: Both the upper panel and lower panel are fixed with two fasteners respectively to connect to the side panels.</p>
<p>2. Remove the electric box.</p>		<ul style="list-style-type: none"> ●Disconnect internal and external connecting lines of the electric box. ●Protect the internal parts during the disassembly.

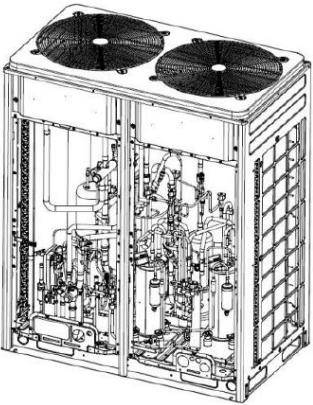
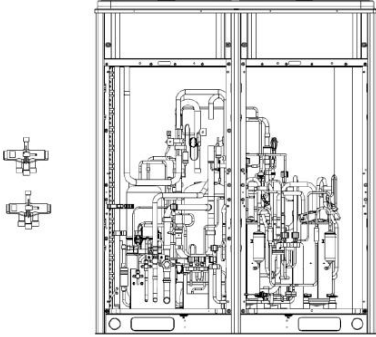
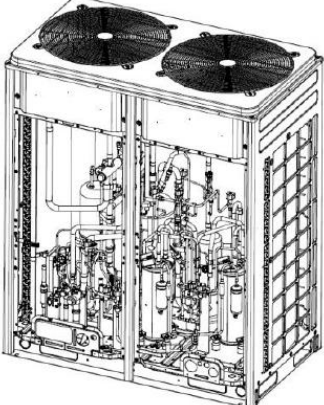
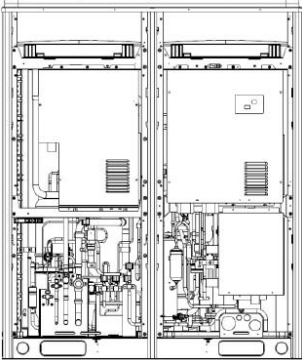
<p>3. Disassemble the four-way valve.</p>		<p>Use a screwdriver to unscrew accessories of the four-way valve. Remove the accessories.</p> <ul style="list-style-type: none"> ● Heat the connecting pipes of the four-way valve by acetylene welding and then remove the pipes. ● Record the direction of the valve and position of the pipe joints. <p>Note: Avoid nearby parts from being burnt during welding.</p>
<p>4. Remove the four-way valve.</p>		<ul style="list-style-type: none"> ● Remove the four-way valve from the pipeline.
<p>5. Install a new four-way valve.</p>		<ul style="list-style-type: none"> ● Put the valve in a proper position. ● Weld the valve with the pipeline. ● Before welding, cover the valve with wet cloth to avoid internal slide from being burnt and prevent water from flowing in the pipeline. ● During welding, charge nitrogen into the pipes. The pressure should be controlled within 0.5 ± 0.1 kgf/cm² (relative pressure).
<p>6. Fix and wire the electric box.</p>		<ul style="list-style-type: none"> ● Put the electric box back to original position and screw it. ● Connect all lines.

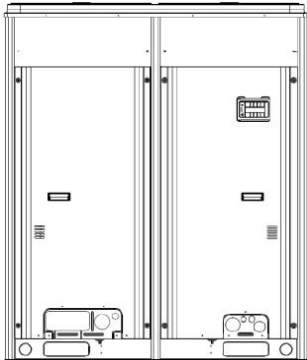
<p>7. Check and install the front panels.</p>		<ul style="list-style-type: none"> ●Check various parts and connecting lines. ●If no problem is found, hook the front panels and tighten the screws.
---	---	--

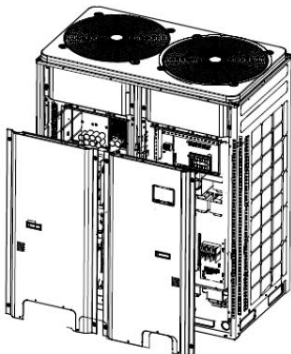
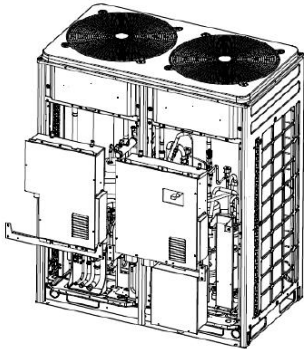
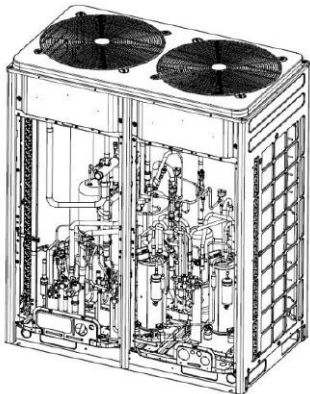
Electric expansion valve		
Precondition: No refrigerant exists in the pipeline system and the power supply has been disconnected		
Step	Diagram	Operation Procedure
<p>1. Loosen the hooks at the bottom of the electric box and the screws.</p>		<ul style="list-style-type: none"> ●Use a screwdriver to unscrew the upper and lower front panels. ●Lift the front panels in order to take it out. <p>Note: Both the upper panel and lower panel are fixed with two fasteners respectively to connect to the side panels.</p>
<p>2. Remove the electric box.</p>		<ul style="list-style-type: none"> ●Disconnect internal and external connecting lines of the electric box. ●Protect the internal parts during the disassembly.
<p>3. Disassemble the electric expansion valve.</p>		<ul style="list-style-type: none"> ●Remove the coil from the electric expansion valve. ●Heat the connecting pipes of the electric expansion valve by welding and remove the pipes. <p>Note: Avoid nearby parts from being burnt during welding.</p>

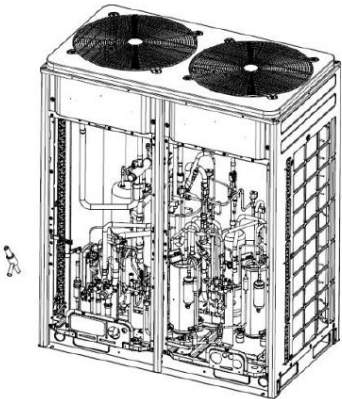
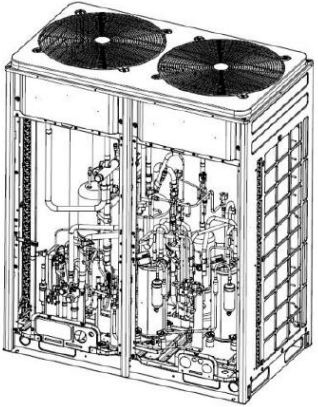
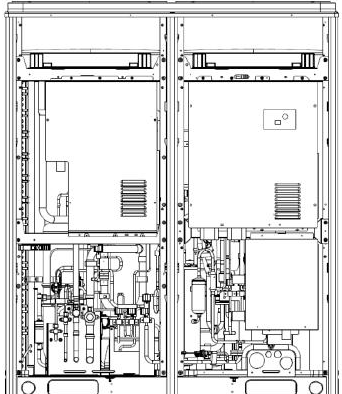
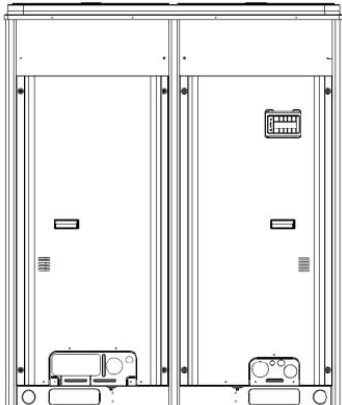
<p>4. Remove the electric expansion valve.</p>		<ul style="list-style-type: none"> ●Remove the electric expansion valve.
<p>5. Install a new electric expansion valve.</p>		<ul style="list-style-type: none"> ●Weld the connecting pipes with the electric expansion valve. ●Before welding, cover the valve with wet cloth. ●During welding, charge nitrogen into the pipes. The pressure should be controlled within 0.5 ± 0.1 kgf/cm² (relative pressure). Note: Avoid nearby parts from being burnt during welding. ●Install the coil on the electric expansion valve.
<p>6. Fix and wire the electric box.</p>		<ul style="list-style-type: none"> ●Put the electric box back to original position and screw it. ●Connect all lines.
<p>7. Check and install the front panels.</p>		<ul style="list-style-type: none"> ●Check various parts and connecting lines. ●If no problem is found, hook the front panels and tighten the screws.

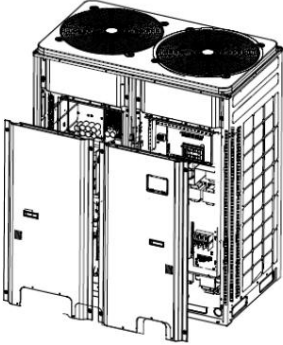
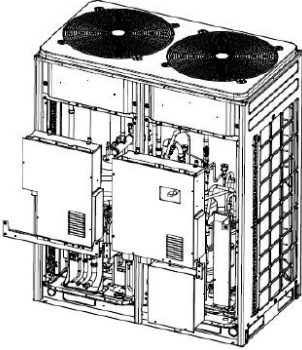
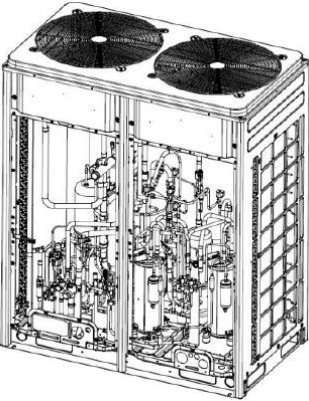
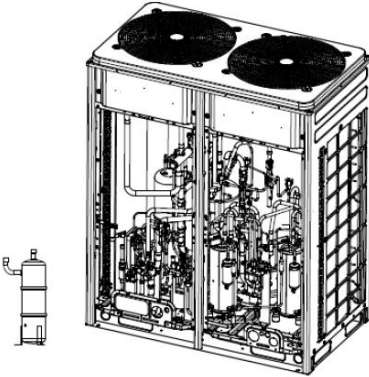
Oil separator		
Precondition: No refrigerant exists in the pipeline system and the power supply has been disconnected.		
Step	Diagram	Operation Procedure
<p>1. Loosen the hooks at the bottom of the electric box and the screws.</p>		<ul style="list-style-type: none"> ●Use a screwdriver to unscrew the upper and lower front panels. ●Lift the front panels in order to take it out. Note: Both the upper panel and lower panel are fixed with two fasteners respectively to connect to the side panels.
<p>2. Remove the electric box.</p>		<ul style="list-style-type: none"> ●Disconnect internal and external connecting lines of the electric box. ●Protect the internal parts during the disassembly.
<p>3. Disassemble the oil separator.</p>		<ul style="list-style-type: none"> ●Use a screwdriver to unscrew the oil separator. ●Loosen the electric heating belt. ●Heat the four pipe joints of the oil separator by welding and remove the connecting pipes. Note: Avoid nearby parts from being burnt during welding.
<p>4. Remove the oil separator.</p>		<ul style="list-style-type: none"> ●Remove the oil separator from the chassis.

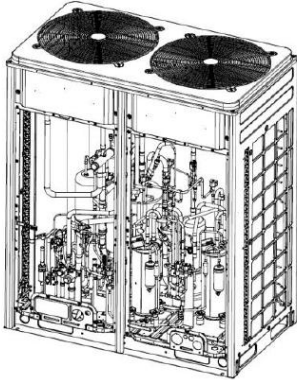
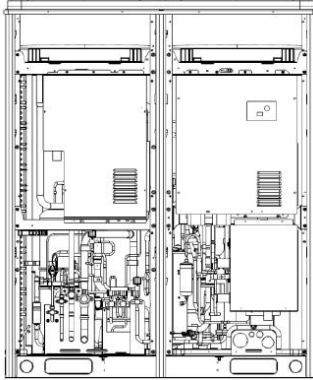
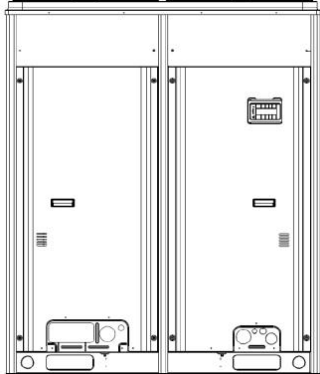
<p>.....5. Install a new oil separator.</p>		<ul style="list-style-type: none"> ●Weld the four pipe joints with the oil separator. During welding, charge nitrogen into the pipes. The pressure should be controlled within 0.5±0.1 kgf/cm² (relative pressure). Note: Avoid nearby parts from being burnt during welding. ●Screw the oil separator. ●Tighten the electric heating belt.
<p>6. Fix and wire the electric box.</p>		<ul style="list-style-type: none"> ●Put the electric box back to original position and screw it. ●Connect all lines.
<p>7. Check and install the front panels.</p>		<ul style="list-style-type: none"> ●Check various parts and connecting lines. ●If no problem is found, hook the front panels and tighten the screws.

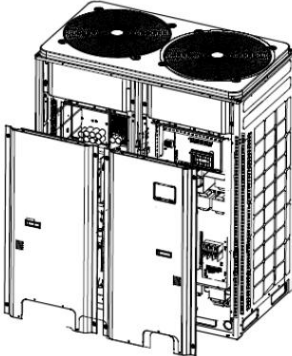
<p style="text-align: center;">Gas/liquid separator</p>		
<p style="text-align: center;">Precondition: No refrigerant exists in the pipeline system and the power supply has been disconnected.</p>		
<p style="text-align: center;">Step</p>	<p style="text-align: center;">Diagram</p>	<p style="text-align: center;">Operation Procedure</p>
<p>1. Loosen the hooks at the bottom of the electric box and the screws.</p>		<ul style="list-style-type: none"> ●Use a screwdriver to unscrew the upper and lower front panels. ●Lift the front panels in order to take it out. Note: Both the upper panel and lower panel are fixed with two fasteners respectively to connect to the side panels.

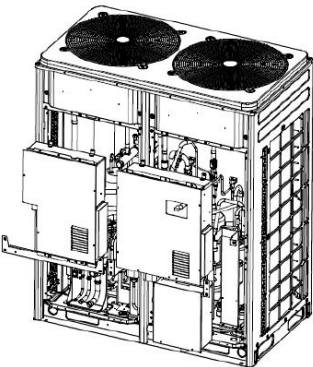
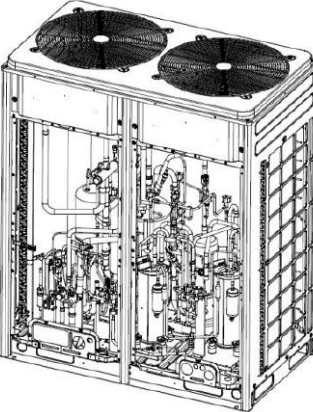
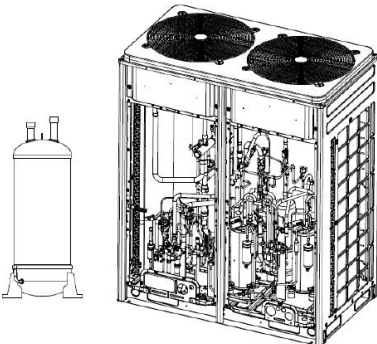
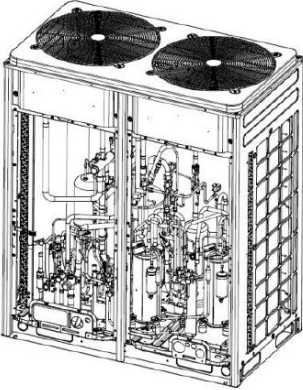
<p>2. Remove the electric box.</p>		<ul style="list-style-type: none"> ● Disconnect internal and external connecting lines of the electric box. ● Protect the internal parts during the disassembly.
<p>3. Disassemble the gas/liquid separator.</p>		<ul style="list-style-type: none"> ● Heat the connecting pipes of the gas/liquid separator by acetylene welding and then remove the pipes. <p>Note: Avoid nearby parts from being burnt during welding.</p>
<p>4. Remove the gas/liquid separator.</p>		<ul style="list-style-type: none"> ● Unscrew and remove the gas/liquid separator.
<p>5. Install a new gas/liquid separator.</p>		<ul style="list-style-type: none"> ● Put the gas/liquid separator based on the position of the suction and discharge pipes and weld the pipes with the gas/liquid separator. ● During welding, charge nitrogen into the pipes. The pressure should be controlled within 0.5 ± 0.1 kgf/cm² (relative pressure). <p>Note: Avoid nearby parts from being burnt during welding.</p> <ul style="list-style-type: none"> ● Screw the gas/liquid separator.

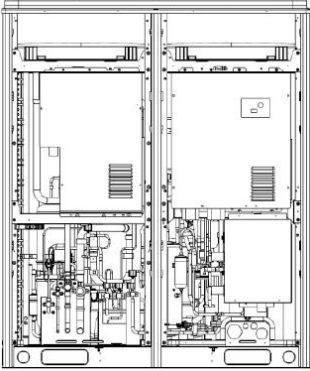
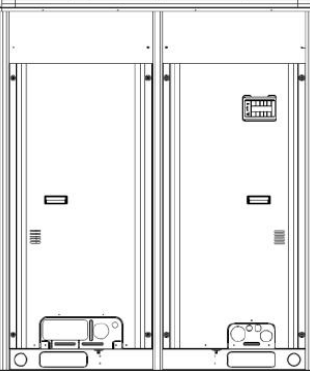
<p>...6. Fix and wire the electric box.</p>		<ul style="list-style-type: none"> ●Put the electric box back to original position and screw it. ●Connect all lines.
<p>7. Check and install the front panels.</p>		<ul style="list-style-type: none"> ●Check various parts and connecting lines. ●If no problem is found, hook the front panels and tighten the screws.

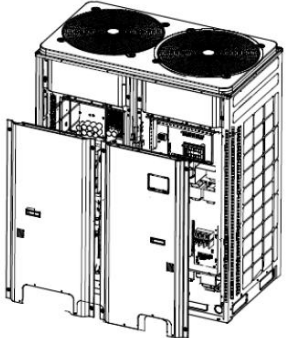
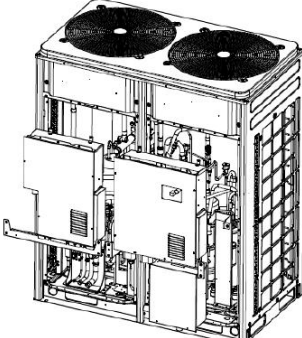
Heat exchanging board		
Precondition: No refrigerant exists in the pipeline system and the power supply has been disconnected.		
Step	Diagram	Operation Procedure
<p>1. Loosen the hooks at the bottom of the electric box and the screws.</p>		<ul style="list-style-type: none"> ●Use a screwdriver to unscrew the upper and lower front panels. ●Lift the front panels in order to take it out. <p>Note: Both the upper panel and lower panel are fixed with two fasteners respectively to connect to the side panels.</p>
<p>2. Remove the electric box.</p>		<ul style="list-style-type: none"> ●Disconnect internal and external connecting lines of the electric box. ●Protect the internal parts during the disassembly.

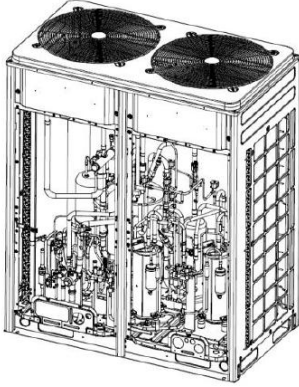
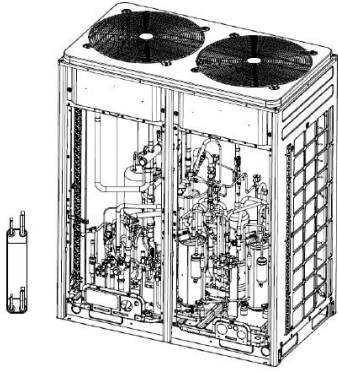
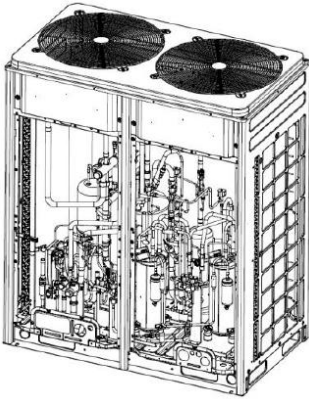
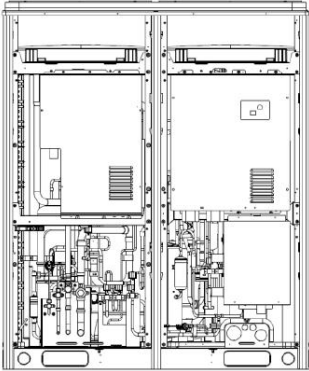
<p>3. Disassemble the heat exchanging board.</p>		<ul style="list-style-type: none"> ●Heat the connecting pipes of the heat exchanging board by acetylene welding and then remove the pipes. Note: Avoid nearby parts from being burnt during welding. The joints of the board must be welded with copper plated steel. Ensure welding quality.
<p>4. Remove the heat exchanging board.</p>		<ul style="list-style-type: none"> ●Unscrew the support of the heat exchanging board, and remove the support and board.
<p>5. Install a new heat exchanging board.</p>		<ul style="list-style-type: none"> ●Screw the support of the heat exchanging board and fix the board onto the chassis. ●Put the heat exchanging board based on the position of the suction and discharge pipes and weld the pipes with the heat exchanging board. ●During welding, charge nitrogen into the pipes. The pressure should be controlled within 0.5 ± 0.1 kgf/cm² (relative pressure). Note: Avoid nearby parts from being burnt during welding.
<p>6. Fix and wire the electric box.</p>		<ul style="list-style-type: none"> ●Put the electric box back to original position and screw it. ●Connect all lines.

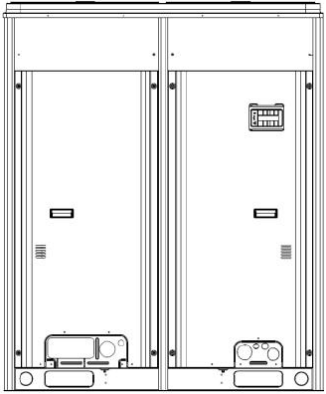
<p>7. Check and install the front panels.</p>		<ul style="list-style-type: none"> ●Check various parts and connecting lines. ●If no problem is found, hook the front panels and tighten the screws.
---	---	--

5 UNIT MAINTENANCE

Check and maintain the unit periodically can prolong the service life of the unit. Please appoint professional person to conduct the maintenance.

5.1 ODU Heat Exchanger

ODU heat exchangers should be cleaned regularly, two months a time at least. Use an absorber and nylon brush to clear surface dusts and stains. If a compressed air ejector is available, spray the heat exchanger with the ejector to clear the dirt. Water is prohibited.

5.2 Discharge Pipe

Periodically check discharge pipes for blockage to make condensing water discharged freely.

5.3 Pre-Season Cautions

- (1) Check IDU and ODUs' air inlets and outlets for blockage.
- (2) Check whether they are properly earthed.
- (3) Check batteries of the remote control.
- (4) Check whether air filters have been properly installed.
- (5) Turn the power switch on 8 hours beforehand to pre-heat the outdoor compressor crankcase before the unit is restarted after being in idle status for a long time.
- (6) Check ODU installation. If an abnormality is found, please contact GREE's maintenance center.

5.4 Post-Season Maintenance

- (1) Disconnect the general power supply.
- (2) Clean air filters and ODUs.
- (3) Clear dusts and stains off IDUs and ODUs.
- (4) For rusty ODUs, apply some paint on them to prevent deterioration.

5.5 Parts Replacement

Contact GREE's local office or dealers to obtain parts.

Note: In the course of air tightness and leakage test, prevent oxygen or acetylene from entering cooling circuits. Nitrogen or refrigerant is recommended.

PART 4 APPENDIXES

1 MINUTES ABOUT A DEBUG SOLUTION CONFIRMATION MEETING

Confirming air conditioner debug solution to the *** project
Theme: ***
Time: ***
Place: ***
Participants: ***
Contents: ***
1
2
3

2 VISUAL INSPECTION CHECKLIST OF THE DEBUG SYSTEM

Visual inspection checklist of *** air conditioning equipment				
	Item	Problem	Checked by	Check time
Refrigerating system	Appearance of ODUs			
	Appearance of IDUs			
	Thermal insulation of copper pipes			
Discharge system	Thermal insulation of condensing pipes			
Electric system	Power line diameter			
	Cabling of power lines			
	Air circuit breaker			
Communication system	Materials of communication lines			
	Connection of communication lines			

3 DEBUG PARAMETER RECORD LIST

Project name				Unit model			
Debugged by				Date			
ODU rated capacity (kW)		General IDU rated capacity (kW)		Total length of refrigerant pipes (m)			
Maximum fall of IDUs (m)				Fill amount of refrigerant (kg)			
Debug state:	Refrigerating	Heating	Number and capacity of running IDUs				
State parameter	Unit	Prestart	30min	60min	90min		
ODU	Outdoor temperature	°F					
	Power voltage	V					
	Frequency	Hz					
	Compressor current	A					
	Discharge temperature	°F					
	System temperature under high pressure	°F					
	System temperature under low pressure	°F					
1# IDU	Rated capacity	kW					
	Ambient temperature	°F					
	IDU gear	Gear					
	Outlet temperature	°F					
	Outlet speed	M/S					
	Noise	dB					
	Water tray	—					
2# IDU	Rated capacity	kW					
	Ambient temperature	°F					
	IDU gear	Gear					
	Outlet temperature	°F					
	Outlet speed	M/S					
	Noise	dB					
	Water tray	—					

4 COMMON PARAMETER LISTS

4.1 R410A Refrigerant Pressure / Saturation Temperature List

Temperature		Corresponding saturation pressure		Temperature		Corresponding saturation pressure		Temperature		Corresponding saturation pressure	
°C	°F	BAR	psi	°C	°F	BAR	psi	°C	°F	BAR	psi
-43	-45.4	1.54	22.34	-9	15.8	5.97	86.59	25	77.0	16.64	241.34
-42	-43.6	1.61	23.35	-8	17.6	6.18	89.63	26	78.8	17.08	247.72
-41	-41.8	1.68	24.37	-7	19.4	6.39	92.68	27	80.6	17.54	254.40
-40	-40.0	1.76	25.53	-6	21.2	6.61	95.87	28	82.4	18.01	261.21
-39	-38.2	1.84	26.69	-5	23.0	6.84	99.21	29	84.2	18.48	268.03
-38	-36.4	1.93	27.99	-4	24.8	7.07	102.54	30	86.0	18.97	275.14
-37	-34.6	2.02	29.30	-3	26.6	7.30	105.88	31	87.8	19.46	282.24
-36	-32.8	2.11	30.60	-2	28.4	7.54	109.36	32	89.6	19.96	289.50
-35	-31.0	2.20	31.91	-1	30.2	7.79	112.98	33	91.4	20.48	297.04
-34	-29.2	2.30	33.36	0	32.0	8.04	116.61	34	93.2	21.00	304.58
-33	-27.4	2.40	34.81	1	33.8	8.30	120.38	35	95.0	21.53	312.27
-32	-25.6	2.50	36.26	2	35.6	8.57	124.30	36	96.8	22.08	320.24
-31	-23.8	2.61	37.85	3	37.4	8.84	128.21	37	98.6	22.63	328.22
-30	-22.0	2.72	39.45	4	39.2	9.12	132.27	38	100.4	23.20	336.49
-29	-20.2	2.83	41.05	5	41.0	9.40	136.34	39	102.2	23.77	344.75
-28	-18.4	2.95	42.79	6	42.8	9.69	140.54	40	104.0	24.36	353.31
-27	-16.6	3.07	44.53	7	44.6	9.99	144.89	41	105.8	24.95	361.87
-26	-14.8	3.19	46.27	8	46.4	10.30	149.39	42	107.6	25.56	370.72
-25	-13.0	3.32	48.15	9	48.2	10.61	153.89	43	109.4	26.18	379.71
-24	-11.2	3.45	50.04	10	50.0	10.93	158.53	44	111.2	26.81	388.85
-23	-9.4	3.59	52.07	11	51.8	11.25	163.17	45	113.0	27.45	398.13
-22	-7.6	3.73	54.10	12	53.6	11.59	168.10	46	114.8	28.10	407.56
-21	-5.8	3.88	56.27	13	55.4	11.93	173.03	47	116.6	28.76	417.13
-20	-4.0	4.03	58.45	14	57.2	12.28	178.11	48	118.4	29.44	426.99
-19	-2.2	4.18	60.63	15	59.0	12.63	183.18	49	120.2	30.13	437.00
-18	-0.4	4.34	62.95	16	60.8	13.00	188.55	50	122.0	30.83	447.15
-17	1.4	4.50	65.27	17	62.6	13.37	193.92	52	125.6	32.26	467.89
-16	3.2	4.67	67.73	18	64.4	13.75	199.43	54	129.2	33.74	489.36
-15	5.0	4.84	70.20	19	66.2	14.13	204.94	56	132.8	35.28	511.69
-14	6.8	5.02	72.81	20	68.0	14.53	210.74	58	136.4	36.86	534.61
-13	8.6	5.20	75.42	21	69.8	14.93	216.54	60	140.0	38.49	558.25
-12	10.4	5.38	78.03	22	71.6	15.35	222.63	62	143.6	40.17	582.62
-11	12.2	5.58	80.93	23	73.4	15.77	228.72	65	149.0	42.78	620.47
-10	14.0	5.77	83.69	24	75.2	16.20	234.96	67	152.6	44.57	646.43

4.2 Resistance / Temperature Lists of Temperature Sensors

4.2.1 Voltage list of 15 kΩ temperature sensors (including ODU and IDU temperature sensors)

T		R	Voltage	T		R	Voltage	T		R	Voltage
°C	°F	kΩ	V	°C	°F	kΩ	V	°C	°F	kΩ	V
-20	-4	144	0.311	41	105.8	7.653	2.185	101	213.8	0.98	3.098
-19	-2.2	138.1	0.323	42	107.6	7.352	2.215	102	215.6	0.952	3.103
-18	-0.4	128.6	0.345	43	109.4	7.065	2.243	103	217.4	0.925	3.108
-17	1.4	121.6	0.362	44	111.2	6.791	2.272	104	219.2	0.898	3.114
-16	3.2	115	0.381	45	113	6.529	2.299	105	221	0.873	3.119
-15	5	108.7	0.4	46	114.8	6.278	2.326	106	222.8	0.848	3.123
-14	6.8	102.9	0.42	47	116.6	6.038	2.353	107	224.6	0.825	3.128
-13	8.6	97.4	0.44	48	118.4	5.809	2.379	108	226.4	0.802	3.133
-12	10.4	92.22	0.462	49	120.2	5.589	2.404	109	228.2	0.779	3.137
-11	12.2	87.35	0.484	50	122	5.379	2.429	110	230	0.758	3.141
-10	14	82.75	0.506	51	123.8	5.179	2.453	111	231.8	0.737	3.145
-9	15.8	78.43	0.53	52	125.6	4.986	2.477	112	233.6	0.717	3.15
-8	17.6	74.35	0.554	53	127.4	4.802	2.5	113	235.4	0.697	3.153
-7	19.4	70.5	0.579	54	129.2	4.625	2.522	114	237.2	0.678	3.157
-6	21.2	66.88	0.605	55	131	4.456	2.544	115	239	0.66	3.161
-5	23	63.46	0.631	56	132.8	4.294	2.566	116	240.8	0.642	3.165
-4	24.8	60.23	0.658	57	134.6	4.139	2.586	117	242.6	0.625	3.168
-3	26.6	57.18	0.686	58	136.4	3.99	2.607	118	244.4	0.608	3.171
-2	28.4	54.31	0.714	59	138.2	3.848	2.626	119	246.2	0.592	3.175
-1	30.2	51.59	0.743	60	140	3.711	2.646	120	248	0.577	3.178
0	32	49.02	0.773	61	141.8	3.579	2.664	121	249.8	0.561	3.181
1	33.8	46.8	0.801	62	143.6	3.454	2.682	122	251.6	0.547	3.184
2	35.6	44.31	0.835	63	145.4	3.333	2.7	123	253.4	0.532	3.187
3	37.4	42.14	0.866	64	147.2	3.217	2.717	124	255.2	0.519	3.19
4	39.2	40.09	0.899	65	149	3.105	2.734	125	257	0.505	3.192
5	41	38.15	0.931	66	150.8	2.998	2.75	126	258.8	0.492	3.195
6	42.8	36.32	0.965	67	152.6	2.898	2.766	127	260.6	0.48	3.198
7	44.6	34.58	0.998	68	154.4	2.797	2.781	128	262.4	0.467	3.2
8	46.4	32.94	1.033	69	156.2	2.702	2.796	129	264.2	0.456	3.203
9	48.2	31.38	1.067	70	158	2.611	2.811	130	266	0.444	3.205
10	50	29.9	1.102	71	159.8	2.523	2.825	131	267.8	0.433	3.207
11	51.8	28.51	1.138	72	161.6	2.439	2.838	132	269.6	0.422	3.21
12	53.6	27.18	1.174	73	163.4	2.358	2.852	133	271.4	0.412	3.212
13	55.4	25.92	1.21	74	165.2	2.28	2.865	134	273.2	0.401	3.214

14	57.2	24.73	1.246	75	167	2.205	2.877	135	275	0.391	3.216
15	59	23.6	1.282	76	168.8	2.133	2.889	136	276.8	0.382	3.218
16	60.8	22.53	1.319	77	170.6	2.064	2.901	137	278.6	0.372	3.22
17	62.6	21.51	1.356	78	172.4	1.997	2.912	138	280.4	0.363	3.222
18	64.4	20.54	1.393	79	174.2	1.933	2.923	139	282.2	0.355	3.224
19	66.2	19.63	1.429	80	176	1.871	2.934	140	284	0.346	3.226
20	68	18.75	1.467	81	177.8	1.811	2.945	141	285.8	0.338	3.227
21	69.8	17.93	1.503	82	179.6	1.754	2.955	142	287.6	0.33	3.229
22	71.6	17.14	1.54	83	181.4	1.699	2.964	143	289.4	0.322	3.231
23	73.4	16.39	1.577	84	183.2	1.645	2.974	144	291.2	0.314	3.232
24	75.2	15.68	1.613	85	185	1.594	2.983	145	293	0.307	3.234
25	77	15	1.65	86	186.8	1.544	2.992	146	294.8	0.299	3.235
26	78.8	14.36	1.686	87	188.6	1.497	3.001	147	296.6	0.292	3.237
27	80.6	13.74	1.722	88	190.4	1.451	3.009	148	298.4	0.286	3.238
28	82.4	13.16	1.758	89	192.2	1.408	3.017	149	300.2	0.279	3.24
29	84.2	12.6	1.793	90	194	1.363	3.025	150	302	0.273	3.241
30	86	12.07	1.829	91	195.8	1.322	3.033	151	303.8	0.266	3.242
31	87.8	11.57	1.863	92	197.6	1.282	3.04	152	305.6	0.261	3.244
32	89.6	11.09	1.897	93	199.4	1.244	3.047	153	307.4	0.254	3.245
33	91.4	10.63	1.931	94	201.2	1.207	3.054	154	309.2	0.248	3.246
34	93.2	10.2	1.964	95	203	1.171	3.061	155	311	0.243	3.247
35	95	9.779	1.998	96	204.8	1.136	3.068	156	312.8	0.237	3.249
36	96.8	9.382	2.03	97	206.6	1.103	3.074	157	314.6	0.232	3.25
37	98.6	9.003	2.062	98	208.4	1.071	3.08	158	316.4	0.227	3.251
38	100.4	8.642	2.094	99	210.2	1.039	3.086	159	318.2	0.222	3.252
39	102.2	5.997	2.125	100	212	1.009	3.092	160	320	0.217	3.253

4.2.2 Voltage list of 20 kΩ pipeline temperature sensors (including temperature sensors for defroster, sub-cooler, gas/liquid separator, and IDU suction and discharge pipes)

T		R	Voltage	T		R	Voltage	T		R	Voltage
°C	°F	kΩ	V	°C	°F	kΩ	V	°C	°F	kΩ	V
-30	-22	361.8	0.173	34	93.2	13.59	1.965	98	208.4	1.427	3.08
-29	-20.2	339.8	0.183	35	95	13.04	1.998	99	210.2	1.386	3.086
-28	-18.4	319.2	0.195	36	96.8	12.51	2.03	100	212	1.346	3.092
-27	-16.6	300	0.206	37	98.6	12	2.063	101	213.8	1.307	3.098
-26	-14.8	282.2	0.218	38	100.4	11.52	2.094	102	215.6	1.269	3.103
-25	-13	265.5	0.231	39	102.2	11.06	2.125	103	217.4	1.233	3.108
-24	-11.2	249.9	0.245	40	104	10.62	2.155	104	219.2	1.198	3.114
-23	-9.4	235.3	0.259	41	105.8	10.2	2.185	105	221	1.164	3.119
-22	-7.6	221.6	0.273	42	107.6	9.803	2.215	106	222.8	1.131	3.123
-21	-5.8	208.9	0.288	43	109.4	9.42	2.243	107	224.6	1.099	3.128
-20	-4	196.9	0.304	44	111.2	9.054	2.272	108	226.4	1.069	3.133
-19	-2.2	181.4	0.328	45	113	8.705	2.299	109	228.2	1.039	3.137
-18	-0.4	171.4	0.345	46	114.8	8.37	2.326	110	230	1.01	3.141
-17	1.4	162.1	0.362	47	116.6	8.051	2.353	111	231.8	0.9825	3.145
-16	3.2	153.3	0.381	48	118.4	7.745	2.379	112	233.6	0.9556	3.15
-15	5	145	0.4	49	120.2	7.453	2.404	113	235.4	0.9295	3.153
-14	6.8	137.2	0.42	50	122	7.173	2.429	114	237.2	0.9043	3.157
-13	8.6	129.9	0.44	51	123.8	6.905	2.453	115	239	0.8799	3.161
-12	10.4	123	0.462	52	125.6	6.648	2.477	116	240.8	0.8562	3.165
-11	12.2	116.5	0.484	53	127.4	6.403	2.5	117	242.6	0.8333	3.168
-10	14	110.3	0.507	54	129.2	6.167	2.522	118	244.4	0.8111	3.171
-9	15.8	104.6	0.53	55	131	5.942	2.544	119	246.2	0.7895	3.175
-8	17.6	99.13	0.554	56	132.8	5.726	2.565	120	248	0.7687	3.178
-7	19.4	94	0.579	57	134.6	5.519	2.586	121	249.8	0.7485	3.181
-6	21.2	89.17	0.605	58	136.4	5.32	2.607	122	251.6	0.7289	3.184
-5	23	84.61	0.631	59	138.2	5.13	2.626	123	253.4	0.7099	3.187
-4	24.8	80.31	0.658	60	140	4.948	2.646	124	255.2	0.6915	3.19
-3	26.6	76.24	0.686	61	141.8	4.773	2.664	125	257	0.6736	3.192
-2	28.4	72.41	0.714	62	143.6	4.605	2.682	126	258.8	0.6563	3.195
-1	30.2	68.79	0.743	63	145.4	4.443	2.7	127	260.6	0.6395	3.198
0	32	65.37	0.773	64	147.2	4.289	2.717	128	262.4	0.6232	3.2
1	33.8	62.13	0.804	65	149	4.14	2.734	129	264.2	0.6074	3.203
2	35.6	59.08	0.835	66	150.8	3.998	2.75	130	266	0.5921	3.205
3	37.4	56.19	0.866	67	152.6	3.861	2.766	131	267.8	0.5772	3.207

4	39.2	53.46	0.898	68	154.4	3.729	2.781	132	269.6	0.5627	3.21
5	41	50.87	0.931	69	156.2	3.603	2.796	133	271.4	0.5487	3.212
6	42.8	48.42	0.965	70	158	3.481	2.811	134	273.2	0.5351	3.214
7	44.6	46.11	0.998	71	159.8	3.364	2.825	135	275	0.5219	3.216
8	46.4	43.92	1.033	72	161.6	3.252	2.838	136	276.8	0.509	3.218
9	48.2	41.84	1.067	73	163.4	3.144	2.852	137	278.6	0.4966	3.22
10	50	39.87	1.102	74	165.2	3.04	2.865	138	280.4	0.4845	3.222
11	51.8	38.01	1.138	75	167	2.94	2.877	139	282.2	0.4727	3.224
12	53.6	36.24	1.174	76	168.8	2.844	2.889	140	284	0.4613	3.226
13	55.4	34.57	1.209	77	170.6	2.752	2.901	141	285.8	0.4502	3.227
14	57.2	32.98	1.246	78	172.4	2.663	2.912	142	287.6	0.4394	3.229
15	59	31.47	1.282	79	174.2	2.577	2.923	143	289.4	0.4289	3.231
16	60.8	30.04	1.319	80	176	2.495	2.934	144	291.2	0.4187	3.232
17	62.6	28.68	1.356	81	177.8	2.415	2.944	145	293	0.4088	3.234
18	64.4	27.39	1.393	82	179.6	2.339	2.954	146	294.8	0.3992	3.235
19	66.2	26.17	1.429	83	181.4	2.265	2.964	147	296.6	0.3899	3.237
20	68	25.01	1.466	84	183.2	2.194	2.974	148	298.4	0.3808	3.238
21	69.8	23.9	1.503	85	185	2.125	2.983	149	300.2	0.3719	3.24
22	71.6	22.85	1.54	86	186.8	2.059	2.992	150	302	0.3633	3.241
23	73.4	21.85	1.577	87	188.6	1.996	3.001	151	303.8	0.3549	3.242
24	75.2	20.9	1.614	88	190.4	1.934	3.009	152	305.6	0.3468	3.244
25	77	20	1.65	89	192.2	1.875	3.017	153	307.4	0.3389	3.245
26	78.8	19.14	1.686	90	194	1.818	3.025	154	309.2	0.3312	3.246
27	80.6	18.32	1.722	91	195.8	1.763	3.033	155	311	0.3237	3.247
28	82.4	17.55	1.758	92	197.6	1.71	3.04	156	312.8	0.3164	3.249
29	84.2	16.8	1.793	93	199.4	1.658	3.047	157	314.6	0.3093	3.25
30	86	16.1	1.828	94	201.2	1.609	3.054	158	316.4	0.3024	3.251
31	87.8	15.43	1.863	95	203	1.561	3.061	159	318.2	0.2956	3.252
32	89.6	14.79	1.897	96	204.8	1.515	3.068	160	320	0.2891	3.253
33	91.4	14.18	1.931	97	206.6	1.47	3.074				

4.2.3 Voltage list of 50 kΩ discharge temperature sensors (including discharge air temperature sensor)

T		R	Voltage	T		R	Voltage	T		R	Voltage
°C	°F	kΩ	V	°C	°F	kΩ	V	°C	°F	kΩ	V
-30	-22	911.56	0.036	31	87.8	37.958	0.688	92	197.6	4.2044	2.323
-29	-20.2	853.66	0.038	32	89.6	36.384	0.711	93	199.4	4.0789	2.344
-28	-18.4	799.98	0.041	33	91.4	34.883	0.735	94	201.2	3.9579	2.364
-27	-16.6	750.18	0.043	34	93.2	33.453	0.759	95	203	3.841	2.384
-26	-14.8	703.92	0.046	35	95	32.088	0.784	96	204.8	3.7283	2.404
-25	-13	660.93	0.049	36	96.8	30.787	0.809	97	206.6	3.6194	2.423
-24	-11.2	620.94	0.052	37	98.6	29.544	0.835	98	208.4	3.5143	2.442
-23	-9.4	583.72	0.056	38	100.4	28.359	0.86	99	210.2	3.4128	2.46
-22	-7.6	549.04	0.059	39	102.2	27.227	0.886	100	212	3.3147	2.478
-21	-5.8	516.71	0.063	40	104	26.147	0.913	101	213.8	3.22	2.496
-20	-4	486.55	0.066	41	105.8	25.114	0.94	102	215.6	3.1285	2.514
-19	-2.2	458.4	0.07	42	107.6	24.128	0.967	103	217.4	3.0401	2.531
-18	-0.4	432.1	0.075	43	109.4	23.186	0.994	104	219.2	2.9547	2.547
-17	1.4	407.51	0.079	44	111.2	22.286	1.022	105	221	2.8721	2.564
-16	3.2	384.51	0.084	45	113	21.425	1.05	106	222.8	2.7922	2.58
-15	5	362.99	0.088	46	114.8	20.601	1.078	107	224.6	2.715	2.595
-14	6.8	342.83	0.094	47	116.6	19.814	1.107	108	226.4	2.6404	2.611
-13	8.6	323.94	0.099	48	118.4	19.061	1.136	109	228.2	2.5682	2.626
-12	10.4	306.23	0.104	49	120.2	18.34	1.164	110	230	2.4983	2.64
-11	12.2	289.61	0.11	50	122	17.651	1.193	111	231.8	2.4308	2.655
-10	14	274.02	0.116	51	123.8	16.99	1.223	112	233.6	2.3654	2.669
-9	15.8	259.37	0.123	52	125.6	16.358	1.252	113	235.4	2.3021	2.682
-8	17.6	245.61	0.129	53	127.4	15.753	1.281	114	237.2	2.2409	2.696
-7	19.4	232.67	0.136	54	129.2	15.173	1.311	115	239	2.1816	2.709
-6	21.2	220.5	0.143	55	131	14.618	1.34	116	240.8	2.1242	2.722
-5	23	209.05	0.151	56	132.8	14.085	1.37	117	242.6	2.0686	2.734
-4	24.8	195.97	0.158	57	134.6	13.575	1.4	118	244.4	2.0148	2.747
-3	26.6	188.12	0.167	58	136.4	13.086	1.429	119	246.2	1.9626	2.759
-2	28.4	178.65	0.175	59	138.2	12.617	1.459	120	248	1.9123	2.77
-1	30.2	169.68	0.184	60	140	12.368	1.475	121	249.8	1.8652	2.781
0	32	161.02	0.193	61	141.8	11.736	1.518	122	251.6	1.8158	2.793
1	33.8	153	0.202	62	143.6	11.322	1.548	123	253.4	1.7698	2.804
2	35.6	145.42	0.212	63	145.4	10.925	1.577	124	255.2	1.7253	2.814
3	37.4	135.96	0.223	64	147.2	10.544	1.606	125	257	1.6821	2.825
4	39.2	131.5	0.233	65	149	10.178	1.635	126	258.8	1.6402	2.835

5	41	126.17	0.242	66	150.8	9.8269	1.664	127	260.6	1.5996	2.845
6	42.8	119.08	0.256	67	152.6	9.4896	1.693	128	262.4	1.5602	2.855
7	44.6	113.37	0.267	68	154.4	9.1655	1.722	129	264.2	1.522	2.864
8	46.4	107.96	0.28	69	156.2	8.9542	1.741	130	266	1.485	2.873
9	48.2	102.85	0.292	70	158	8.5551	1.778	131	267.8	1.449	2.882
10	50	98.006	0.306	71	159.8	5.9676	1.806	132	269.6	1.4141	2.891
11	51.8	93.42	0.319	72	161.6	7.9913	1.834	133	271.4	1.3803	2.9
12	53.6	89.075	0.333	73	163.4	7.7257	1.862	134	273.2	1.3474	2.908
13	55.4	84.956	0.348	74	165.2	7.4702	1.889	135	275	1.3155	2.916
14	57.2	81.052	0.362	75	167	7.2245	1.916	136	276.8	1.2846	2.924
15	59	77.349	0.378	76	168.8	6.9882	1.943	137	278.6	1.2545	2.932
16	60.8	73.896	0.393	77	170.6	6.7608	1.969	138	280.4	1.2233	2.94
17	62.6	70.503	0.41	78	172.4	6.542	1.995	139	282.2	1.1969	2.947
18	64.4	67.338	0.427	79	174.2	6.3315	2.021	140	284	1.1694	2.955
19	66.2	64.333	0.444	80	176	6.1288	2.046	141	285.8	1.1476	2.96
20	68	61.478	0.462	81	177.8	5.9336	2.071	142	287.6	1.1166	2.969
21	69.8	58.766	0.48	82	179.6	5.7457	2.096	143	289.4	1.0913	2.975
22	71.6	56.189	0.499	83	181.4	5.5647	2.12	144	291.2	1.0667	2.982
23	73.4	53.738	0.518	84	183.2	5.3903	2.144	145	293	1.0429	2.988
24	75.2	51.408	0.537	85	185	5.2223	2.168	146	294.8	1.0197	2.995
25	77	49.191	0.558	86	186.8	5.0605	2.191	147	296.6	0.9971	3.001
26	78.8	47.082	0.578	87	188.6	4.9044	2.214	148	298.4	0.9752	3.007
27	80.6	45.074	0.599	88	190.4	4.7541	2.237	149	300.2	0.9538	3.013
28	82.4	43.163	0.621	89	192.2	4.6091	2.259	150	302	0.9331	3.018
29	84.2	41.313	0.643	90	194	4.4693	2.281				
30	86	39.61	0.665	91	195.8	4.3345	2.302				

4.3 Voltage / Pressure Lists of Pressure Sensors

4.3.1 High-pressure/ middle-pressure sensor (R410A)

Temperature		Absolute pressure		Voltage	Temperature		Absolute pressure		Voltage
°C	°F	kPa	psi	V	°C	°F	kPa	psi	V
-40	-40	176	25.5	0.102	16	60.8	1300	188.5	1.3
-39	-38.2	184	26.7	0.111	17	62.6	1337	193.9	1.34
-38	-36.4	193	28	0.12	18	64.4	1375	199.4	1.38
-37	-34.6	202	29.3	0.13	19	66.2	1413	204.9	1.421
-36	-32.8	211	30.6	0.139	20	68	1453	210.7	1.463
-35	-31	220	31.9	0.149	21	69.8	1493	216.5	1.506
-34	-29.2	230	33.4	0.16	22	71.6	1535	222.6	1.551
-33	-27.4	240	34.8	0.17	23	73.4	1577	228.7	1.596
-32	-25.6	250	36.3	0.181	24	75.2	1620	234.9	1.641
-31	-23.8	261	37.8	0.193	25	77	1664	241.3	1.688
-30	-22	273	39.6	0.206	26	78.8	1708	247.7	1.735
-29	-20.2	283	41	0.216	27	80.6	1754	254.3	1.784
-28	-18.4	295	42.8	0.229	28	82.4	1801	261.1	1.834
-27	-16.6	307	44.5	0.242	29	84.2	1848	268	1.884
-26	-14.8	319	46.3	0.255	30	86	1897	275.1	1.937
-25	-13	332	48.1	0.268	31	87.8	1946	282.2	1.989
-24	-11.2	345	50	0.282	32	89.6	1996	289.4	2.042
-23	-9.4	359	52.1	0.297	33	91.4	2048	297	2.098
-22	-7.6	373	54.1	0.312	34	93.2	2100	304.5	2.153
-21	-5.8	388	56.3	0.328	35	95	2153	312.2	2.21
-20	-4	403	58.4	0.344	36	96.8	2208	320.2	2.268
-19	-2.2	418	60.6	0.36	37	98.6	2263	328.1	2.327
-18	-0.4	434	62.9	0.377	38	100.4	2320	336.4	2.388
-17	1.4	450	65.3	0.394	39	102.2	2377	344.7	2.448
-16	3.2	467	67.7	0.412	40	104	2436	353.2	2.511
-15	5	484	70.2	0.43	41	105.8	2495	361.8	2.574
-14	6.8	502	72.8	0.45	42	107.6	2556	370.6	2.639
-13	8.6	520	75.4	0.469	43	109.4	2618	379.6	2.705
-12	10.4	538	78	0.488	44	111.2	2681	388.7	2.772
-11	12.2	558	80.9	0.509	45	113	2745	398	2.841
-10	14	577	83.7	0.53	46	114.8	2810	407.5	2.91
-9	15.8	597	86.6	0.551	47	116.6	2876	417	2.98
-8	17.6	618	89.6	0.573	48	118.4	2944	426.9	3.053
-7	19.4	639	92.7	0.596	49	120.2	3013	436.9	3.126

-6	21.2	661	95.8	0.619	50	122	3083	447	3.201
-5	23	684	99.2	0.644	51	123.8	3154	457.3	3.277
-4	24.8	707	102.5	0.668	52	125.6	3226	467.8	3.353
-3	26.6	730	105.9	0.693	53	127.4	3300	478.5	3.432
-2	28.4	754	109.3	0.718	54	129.2	3374	489.2	3.511
-1	30.2	779	113	0.745	55	131	3450	500.3	3.592
0	32	804	116.6	0.772	56	132.8	3528	511.6	3.675
1	33.8	830	120.4	0.799	57	134.6	3606	522.9	3.759
2	35.6	857	124.3	0.828	58	136.4	3686	534.5	3.844
3	37.4	884	128.2	0.857	59	138.2	3767	546.2	3.93
4	39.2	912	132.2	0.887	60	140	3849	558.1	4.018
5	41	940	136.3	0.917	61	141.8	3932	570.1	4.106
6	42.8	969	140.5	0.947	62	143.6	4017	582.5	4.197
7	44.6	999	144.9	0.979	63	145.4	4103	594.9	4.288
8	46.4	1030	149.4	1.012	64	147.2	4190	607.6	4.381
9	48.2	1061	153.8	1.046	65	149	4278	620.3	4.475
10	50	1093	158.5	1.08	66	150.8	4367	633.2	4.57
11	51.8	1125	163.1	1.114	67	152.6	4457	646.3	4.666
12	53.6	1159	168.1	1.15	68	154.4	4548	659.5	4.763
13	55.4	1193	173	1.186	69	156.2	4639	672.7	4.86
14	57.2	1228	178.1	1.224	70	158	4731	686	4.958
15	59	1263	183.1	1.261	71	159.8	4893	709.5	5.13

4.3.2 Low-pressure sensor (R410A)

Temperature		Absolute pressure		Voltage	Temperature		Absolute pressure		Voltage
°C	°F	kPa	psi	V	°C	°F	kPa	psi	V
-70	-94	36	5.2	0.369	-14	6.8	502	72.8	1.301
-69	-92.2	38	5.5	0.373	-13	8.6	520	75.4	1.337
-68	-90.4	40	5.8	0.377	-12	10.4	538	78	1.373
-67	-88.6	43	6.2	0.383	-11	12.2	558	80.9	1.413
-66	-86.8	46	6.7	0.389	-10	14	577	83.7	1.451
-65	-85	48	7	0.393	-9	15.8	597	86.6	1.491
-64	-83.2	51	7.4	0.399	-8	17.6	618	89.6	1.533
-63	-81.4	54	7.8	0.405	-7	19.4	639	92.7	1.575
-62	-79.6	57	8.3	0.411	-6	21.2	661	95.8	1.619
-61	-77.8	61	8.8	0.419	-5	23	684	99.2	1.665
-60	-76	64	9.3	0.425	-4	24.8	707	102.5	1.711
-59	-74.2	68	9.9	0.433	-3	26.6	730	105.9	1.757
-58	-72.4	72	10.4	0.441	-2	28.4	754	109.3	1.805
-57	-70.6	76	11	0.449	-1	30.2	799	115.9	1.895
-56	-68.8	80	11.6	0.457	0	32	804	116.6	1.905
-55	-67	84	12.2	0.465	1	33.8	830	120.4	1.957
-54	-65.2	89	12.9	0.475	2	35.6	857	124.3	2.011
-53	-63.4	94	13.6	0.485	3	37.4	884	128.2	2.065
-52	-61.6	99	14.4	0.495	4	39.2	912	132.2	2.121
-51	-59.8	104	15.1	0.505	5	41	940	136.3	2.177
-50	-58	109	15.8	0.515	6	42.8	969	140.5	2.235
-49	-56.2	115	16.7	0.527	7	44.6	999	144.9	2.295
-48	-54.4	121	17.5	0.539	8	46.4	1030	149.4	2.357
-47	-52.6	127	18.4	0.551	9	48.2	1061	153.8	2.419
-46	-50.8	133	19.3	0.563	10	50	1096	158.9	2.489
-45	-49	140	20.3	0.577	11	51.8	1125	163.1	2.547
-44	-47.2	146	21.2	0.589	12	53.6	1159	168.1	2.615
-43	-45.4	154	22.3	0.605	13	55.4	1193	173	2.683
-42	-43.6	161	23.3	0.619	14	57.2	1228	178.1	2.753
-41	-41.8	168	24.4	0.633	15	59	1263	183.1	2.823
-40	-40	176	25.5	0.649	16	60.8	1300	188.5	2.897
-39	-38.2	184	26.7	0.665	17	62.6	1337	193.9	2.971
-38	-36.4	193	28	0.683	18	64.4	1375	199.4	3.047
-37	-34.6	202	29.3	0.701	19	66.2	1413	204.9	3.123
-36	-32.8	211	30.6	0.719	20	68	1453	210.7	3.203

-35	-31	220	31.9	0.737	21	69.8	1493	216.5	3.283
-34	-29.2	230	33.4	0.757	22	71.6	1535	222.6	3.367
-33	-27.4	240	34.8	0.777	23	73.4	1577	228.7	3.451
-32	-25.6	250	36.3	0.797	24	75.2	1620	234.9	3.537
-31	-23.8	261	37.8	0.819	25	77	1664	241.3	3.625
-30	-22	272	39.4	0.841	26	78.8	1708	247.7	3.713
-29	-20.2	283	41	0.863	27	80.6	1754	254.3	3.805
-28	-18.4	295	42.8	0.887	28	82.4	1801	261.1	3.899
-27	-16.6	307	44.5	0.911	29	84.2	1848	268	3.993
-26	-14.8	319	46.3	0.935	30	86	1897	275.1	4.091
-25	-13	332	48.1	0.961	31	87.8	1946	282.2	4.189
-24	-11.2	345	50	0.987	32	89.6	1996	289.4	4.289
-23	-9.4	359	52.1	1.015	33	91.4	2048	297	4.393
-22	-7.6	373	54.1	1.043	34	93.2	2100	304.5	4.497
-21	-5.8	388	56.3	1.073	35	95	2153	312.2	4.603
-20	-4	403	58.4	1.103	36	96.8	2208	320.2	4.713
-19	-2.2	418	60.6	1.133	37	98.6	2263	328.1	4.823
-18	-0.4	434	62.9	1.165	38	100.4	2320	336.4	4.937
-17	1.4	450	65.3	1.197	39	102.2	2377	344.7	5.051
-16	3.2	467	67.7	1.231	40	104	2439	353.7	5.175
-15	5	484	70.2	1.265					

5 EXPLODED VIEWS AND SPARE PART LIST

5.1 GMV-VQ72W/A-F(U)、GMV-VQ96W/A-F(U)

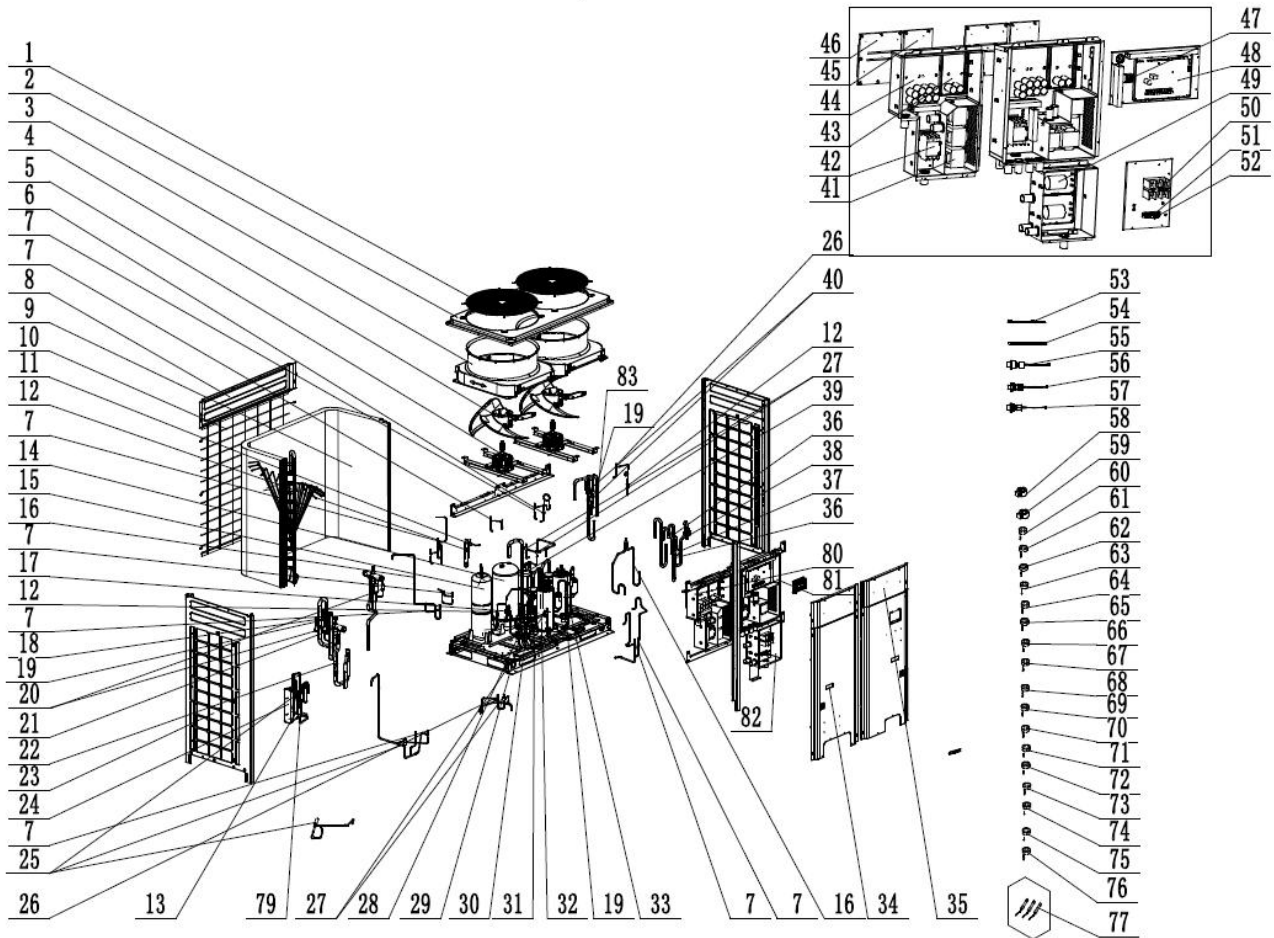

1) GMV-VQ96W/A-F(U)

No.	Name of Part	Part Code	Quantity	No.	Name of Part	Part Code	Quantity
1	Rear Grill	01574100002	2	43	Main Board	300027000315	2
2	Coping	01264100006	1	44	Main Board	300027000198	2
3	Diversion Circle	10474100002	2	45	Radiator	430034000034	2
4	Axial Flow Fan	10434100002	2	46	Radiator	430034000033	2
5	Fan Motor	15704119	2	47	Terminal Board	42018000026	1
6	Strainer	07210022	1	48	Main Board	300027000196	1
7	Electromagnetic Valve	43000054	8	49	Filter Board	300027000260	2
8	Upper Cover Plate (back)	01264100005	1	50	Terminal Board	42018000558	1
9	Condenser Assy	0115410001201	1	51	Insulation Gasket	70415001	1
10	Rear Grill	01574100001	1	52	Wire Clamp	71015001	1
11	Electromagnetic Valve	43000055	1	53	Electrical Heater(Compressor)	765152128	1
12	Strainer	07415200002	3	54	Electrical Heater(Compressor)	7651521212	1

13	One way Valve	04324001	1	55	Pressure sensor	32218000008	1
14	Gas-liquid Separator	035027000007	1	56	Pressure Sensor(High Pressure)	322101037	1
15	Accumulator	07424100036	1	57	Pressure Sensor	32218000009	1
16	One Way Valve	07130101	1	58	Electric Expand Valve Fitting	4304413202	1
17	Strainer A	07211191	1	59	Electric Expand Valve Fitting	4304413204	1
18	Joint	06652200001	1	60	Magnet Coil (electromagnetic valve)	4304000457	1
19	Nozzle for Adding Freon	06120012	3	61	Magnet Coil (electromagnetic valve)	4304000480	1
20	Strainer	07414100006	2	62	Magnet Coil (electromagnetic valve)	4304000460	1
21	4-Way Valve	072007000003	2	63	Magnet Coil	4304000435	1
22	Filter	07218603	1	64	Magnet Coil (electromagnetic valve)	4304000461	1
23	Right Side Plate	01314713P	1	65	Magnet Coil (electromagnetic valve)	4304000452	1
24	Plate-type Heat Exchanger	030166000043	1	66	4 Way Valve Coil	4300040092	1
25	Discharge Charge Valve	07334100002	3	67	Magnet Coil (electromagnetic valve)	4304000459	1
26	Electromagnetic Valve	43044100144	2	68	Magnet Coil (electromagnetic valve)	4304000470	1
27	Electromagnetic Valve	43000072	4	69	Magnet Coil	4304000486	1
28	Cut off Valve 1/4	071302398	1	70	Magnet Coil (electromagnetic valve)	4304000462	1
29	Cut off Valve	07334100011	1	71	Magnet Coil (electromagnetic valve)	4304000458	1
30	Cut off valve	07334100054	1	72	Magnet Coil	4304000456	1
31	Cut off Valve	07334100014	1	73	4 Way Valve Coil	4300040092	1
32	Compressor and Fittings	09001000164	2	74	Magnet Coil (electromagnetic valve)	4304000481	1
33	One Way Valve	07136007	1	75	Magnet Coil (electromagnetic valve)	4304000463	1
34	Screw Sub-Assy	26904100016	2	76	Magnet Coil (electromagnetic valve)	4304000465	1
35	Top Cover (front)	01264100004P	2	77	Sensor Sub-assy	390002000044	3
36	One Way Valve	07333700032	2	78	Electronic Expansion Valve	43044100173	1
37	Pressure Protect Switch	4602000910	1	79	Electronic Expansion Valve	072009000001	1
38	Pressure Protect Switch	4602000911	1	80	Electric Box Assy	100002003230	1
39	Oil Separator	0742418601	1	81	Electric Box Assy	100002003231	1

40	One Way Valve	07335210	2	82	Electric Box Assy	10002003754	1
41	Reactor	450004060002	6	83	Nozzle for Adding Freon	061200101	1
42	AC Contactor	441007060001	2				
Note: Above data is subject to change without notice, please refer the SP in global service website.							

2) GMV-VQ72W/A-F(U)

No.	Name of Part	Part Code	Quantity	No.	Name of Part	Part Code	Quantity
1	Rear Grill	01574100002	2	43	Main Board	300027000315	2
2	Coping	01264100006	1	44	Main Board	300027000198	2
3	Diversion Circle	10474100002	2	45	Radiator	430034000034	2
4	Axial Flow Fan	10434100002	2	46	Radiator	430034000033	2
5	Fan Motor	15704119	2	47	Terminal Board	42018000026	1
6	Strainer	07210022	1	48	Main Board	300027000195	1
7	Electromagnetic Valve	43000054	8	49	Filter Board	300027000260	2
8	Upper Cover Plate (back)	01264100005	1	50	Terminal Board	42018000558	1
9	Condenser Assy	0115410001201	1	51	Insulation Gasket	70415001	1
10	Rear Grill	01574100001	1	52	Wire Clamp	71015001	1
11	Electromagnetic Valve	43000055	1	53	Electrical Heater(Compressor)	765152128	1
12	Strainer	07415200002	3	54	Electrical Heater(Compressor)	7651521212	1
13	One way Valve	04324001	1	55	Pressure sensor	32218000008	1
14	Gas-liquid Separator	035027000007	1	56	Pressure Sensor(High Pressure)	322101037	1
15	Accumulator	07424100036	1	57	Pressure Sensor	32218000009	1
16	One Way Valve	07130101	1	58	Electric Expand Valve Fitting	4304413202	1
17	Strainer A	07211191	1	59	Electric Expand Valve Fitting	4304413204	1
18	Joint	06652200001	1	60	Magnet Coil (electromagnetic valve)	4304000457	1
19	Nozzle for Adding Freon	06120012	3	61	Magnet Coil (electromagnetic valve)	4304000480	1
20	Strainer	07414100006	2	62	Magnet Coil (electromagnetic valve)	4304000460	1
21	4-Way Valve	072007000003	2	63	Magnet Coil	4304000435	1
22	Filter	07218603	1	64	Magnet Coil (electromagnetic valve)	4304000461	1
23	Right Side Plate	01314713P	1	65	Magnet Coil (electromagnetic valve)	4304000452	1
24	Plate-type Heat Exchanger	030166000043	1	66	4 Way Valve Coil	4300040092	1
25	Discharge Charge Valve	07334100002	3	67	Magnet Coil (electromagnetic valve)	4304000459	1

26	Electromagnetic Valve	43044100144	2	68	Magnet Coil (electromagnetic valve)	4304000470	1
27	Electromagnetic Valve	43000072	4	69	Magnet Coil	4304000486	1
28	Cut off Valve 1/4	071302398	1	70	Magnet Coil (electromagnetic valve)	4304000462	1
29	Cut off Valve	07334100011	1	71	Magnet Coil (electromagnetic valve)	4304000458	1
30	Cut off valve	07334100054	1	72	Magnet Coil	4304000456	1
31	Cut off Valve	07334100014	1	73	4 Way Valve Coil	4300040092	1
32	Compressor and Fittings	09001000164	2	74	Magnet Coil (electromagnetic valve)	4304000481	1
33	One Way Valve	07136007	1	75	Magnet Coil (electromagnetic valve)	4304000463	1
34	Screw Sub-Assy	26904100016	2	76	Magnet Coil (electromagnetic valve)	4304000465	1
35	Top Cover (front)	01264100004P	2	77	Sensor Sub-assy	390002000044	3
36	One Way Valve	07333700032	2	78	Electronic Expansion Valve	43044100173	1
37	Pressure Protect Switch	4602000910	1	79	Electronic Expansion Valve	072009000001	1
38	Pressure Protect Switch	4602000911	1	80	Electric Box Assy	100002003230	1
39	Oil Separator	0742418601	1	81	Electric Box Assy	100002003229	1
40	One Way Valve	07335210	2	82	Electric Box Assy	100002003754	1
41	Reactor	450004060002	6	83	Nozzle for Adding Freon	061200101	1
42	AC Contactor	441007060001	2				
Note: Above data is subject to change without notice, please refer the SP in global service website.							

5.2 NCHS1B(U)

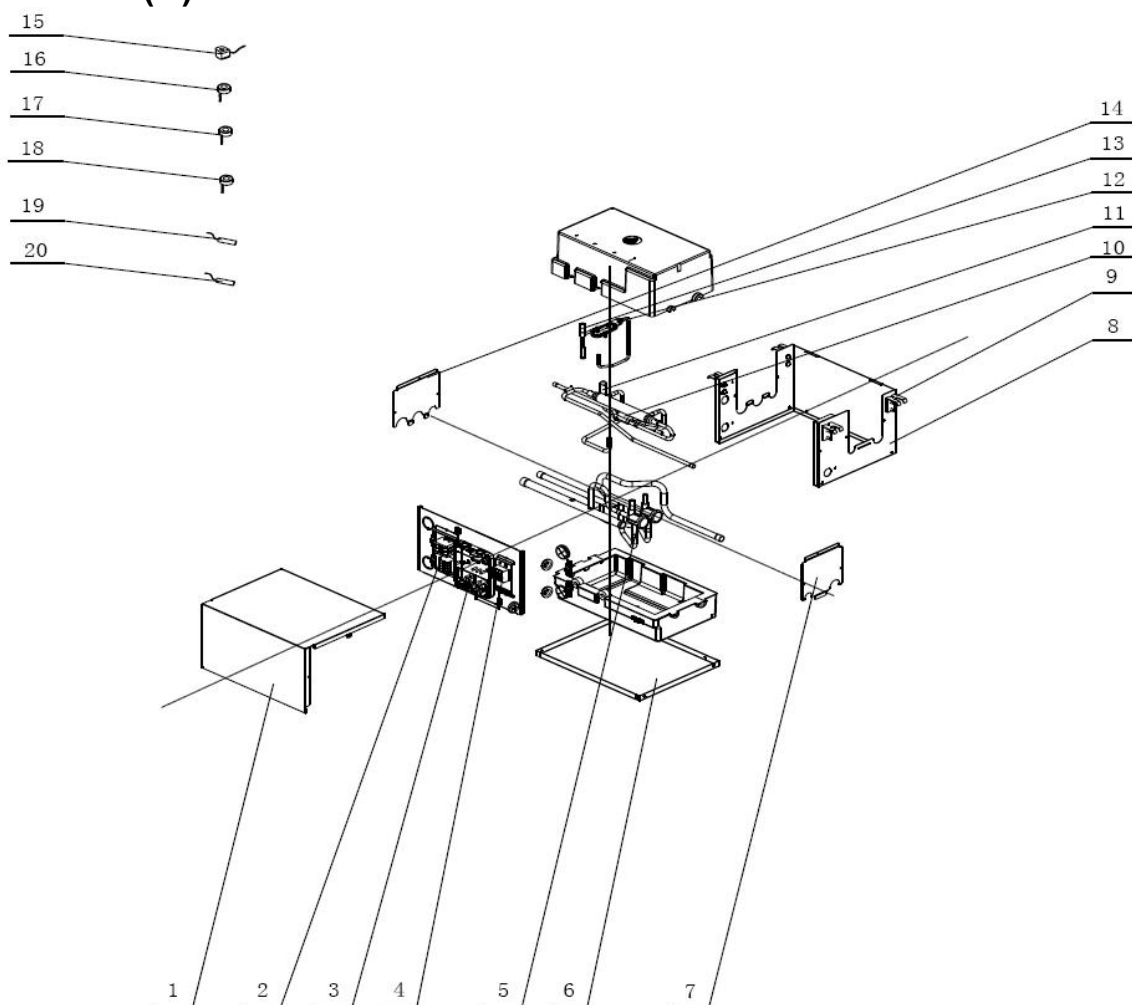

No.	Name of part	NCHS1B(U)	
		Product Code	EN04001120
		Part code	Quantity
1	Coping	'01264100055P	1
2	Terminal Board	'420111451	1
3	Pinboard	'30270000002	1
4	Terminal Board	'42018000026	2
5	Electromagnetic Valve	'43000073	2
6	Chassis	'01284100129P	1
7	Seal plate	'01494100015P	1
8	Side Plate	'01314100096P	1
9	Hook	'02112446	4
10	Strainer	'0741410000601	2
11	Electronic Expansion Valve	'07334463	1
12	Strainer	'07415200002	1

13	Electromagnetic Valve	'43000054	1
14	Seal plate	'01494100014P	1
15	Electric Expand Valve Fitting	'4304413205	1
16	Magnet Coil	'4304000428	1
17	Magnet Coil	'4304000447	1
18	Magnet Coil	'4304000448	1
19	Tube sensor	'3900012128G	1
20	Temperature Sensor	'390000372G	1
Note: Above data is subject to change without notice, please refer the SP in global service website.			

5.3 NCHS2B(U)

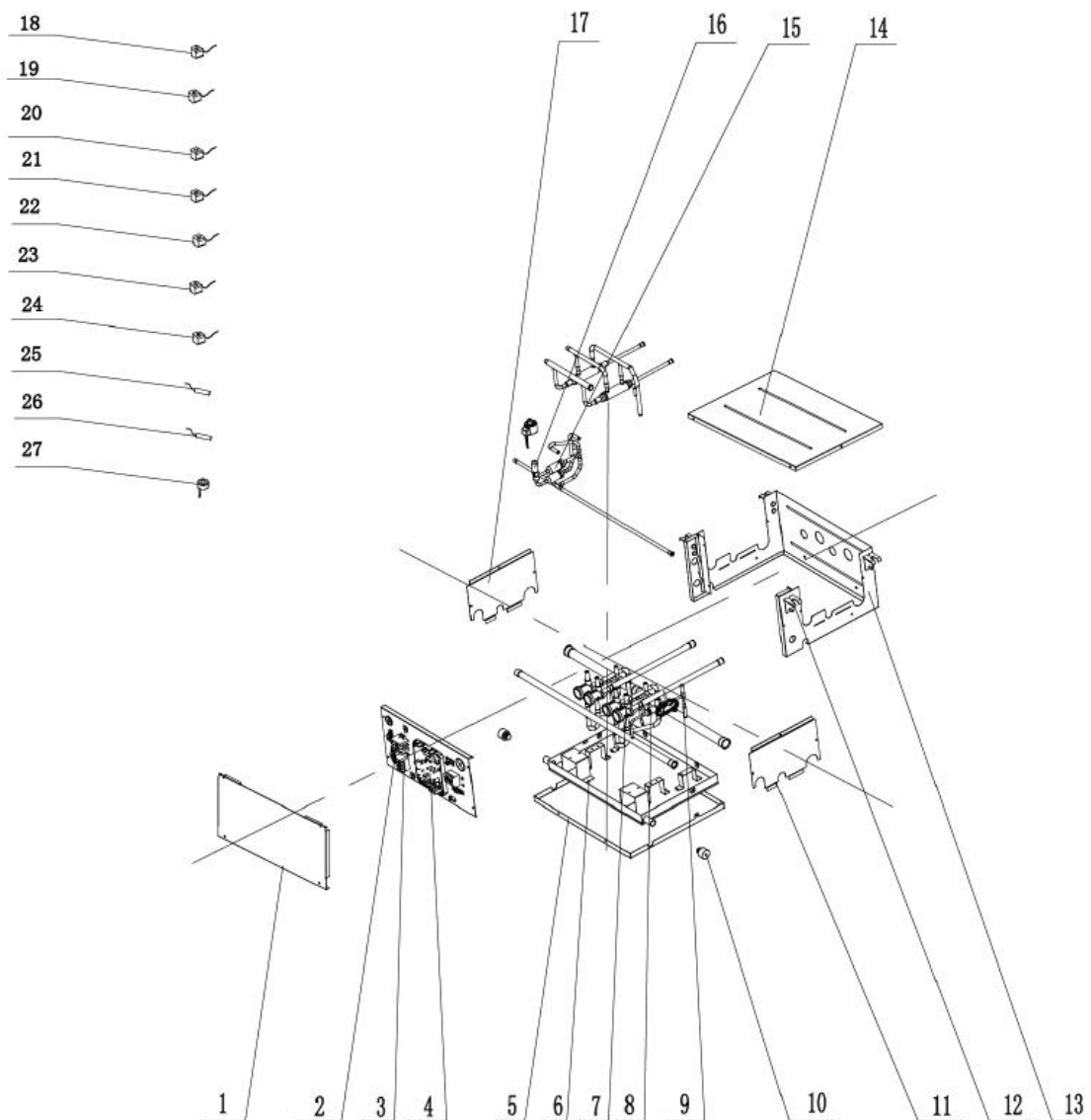

No.	Name of part	NCHS2B(U)	
		Product Code	EN01600010
		Part code	Quantity
1	Top Cover	'012020060141P	1
2	Terminal Board	'422000000014	1
3	Terminal Board	'42018000026	2
4	Pinboard	'300023000009	1
5	Chassis	'012008000028P	1
6	Water Tray Sub_Assy	'017055000063P	1
7	Electromagnetic Valve	'43000073	2
8	Strainer	'07415200002	1
9	Electromagnetic Valve	'43000054	1
10	Choke plug of Drain Pipe	'76712455	2
11	Seal plate	'012034000091	1
12	Hook	'02112446	4
13	Side Plate	'017110000026	1
14	Cover plate	'012035000094	1
15	Strainer	'0741410000601	2
16	Electronic Expansion Valve	'07334463	1
17	Seal Plate	'012034000092	1
18	Magnet Coil	'4304000469	1
19	Magnet Coil	'4304000471	1
20	Magnet Coil	'4304000466	1
21	Magnet Coil	'4304000467	1
22	Magnet Coil	'4304000470	1
23	Magnet Coil	'4304000468	1
24	Magnet Coil	'4304000465	1
25	Temperature Sensor	'3900012139G	1
26	Temperature Sensor	'3900012128G	1
27	Electric Expand Valve Fitting	'4304413215	1
Note: Above data is subject to change without notice, please refer the SP in global service website.			

5.4 NCHS4B(U)

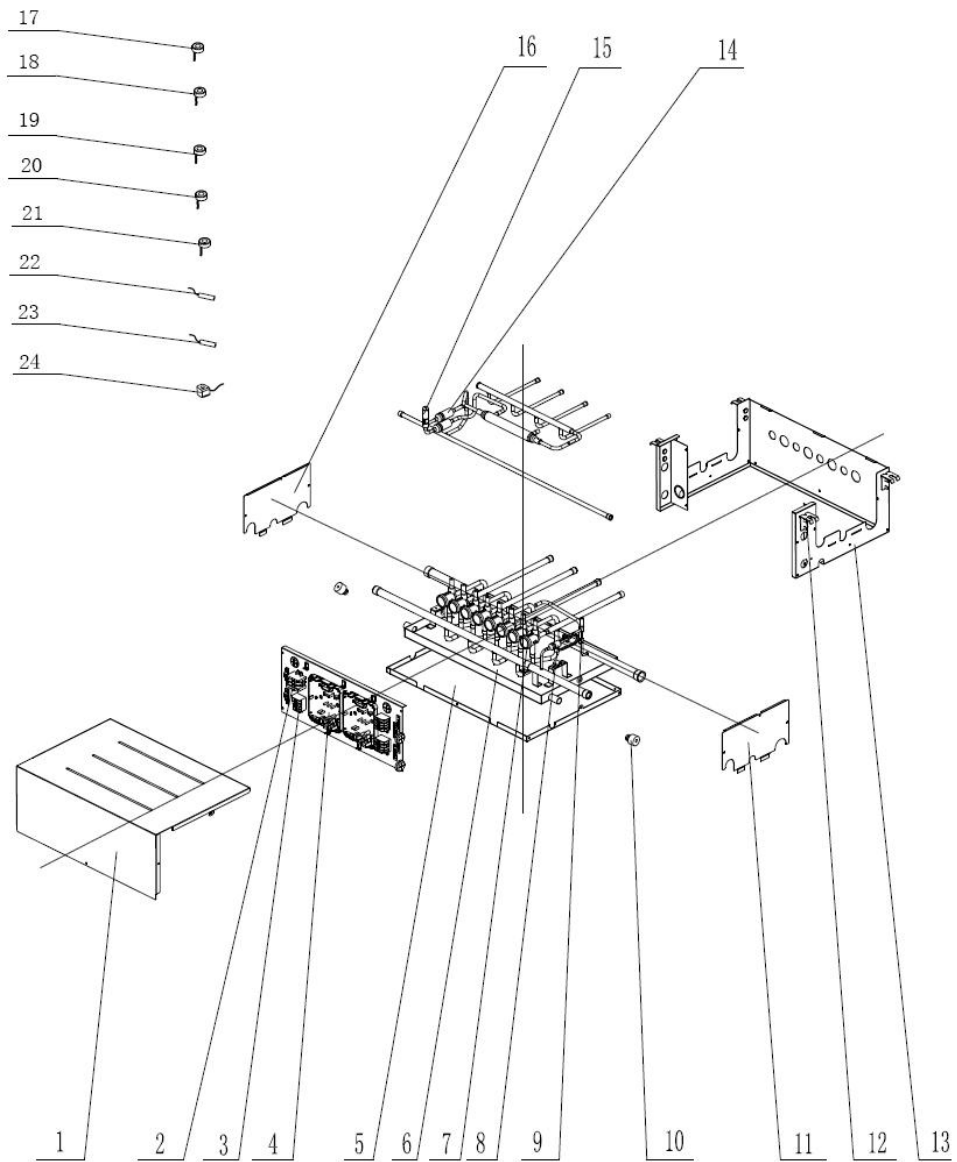

No.	Name of part	NCHS4B(U)	
		Product Code	EN04001130
		Part code	Quantity
1	Coping	'01264100058P	1
2	Terminal Board	'420111451	1
3	Terminal Board	'42018000026	3
4	Pinboard	'30270000002	2
5	Chassis	'01284100135P	1
6	Water Tray Sub-Assy	'01284100147P	1
7	Electromagnetic Valve	'43000073	8
8	Strainer	'07415200002	1
9	Electromagnetic Valve	'43000054	1
10	Choke Plug of Drain Pipe	'76712455	2
11	Seal plate	'01494100018P	1
12	Hook	'02112446	4
13	Side Plate	'01314100100P	1
14	Strainer	'0741410000601	2
15	Electronic Expansion Valve	'07334463	1
16	Seal plate	'01494100017P	1
17	Magnet Coil	'4304000428	1
18	Magnet Coil	'4304000448	2
19	Magnet Coil	'4304000447	2
20	Magnet Coil	'4304000449	2
21	Magnet Coil	'4304000446	2
22	Tube sensor	'3900012128G	1
23	Temperature Sensor	'390000372G	1
24	Electric Expand Valve Fitting	'4304413205	1
Note: Above data is subject to change without notice, please refer the SP in global service website.			

5.5 NCHS8B(U)

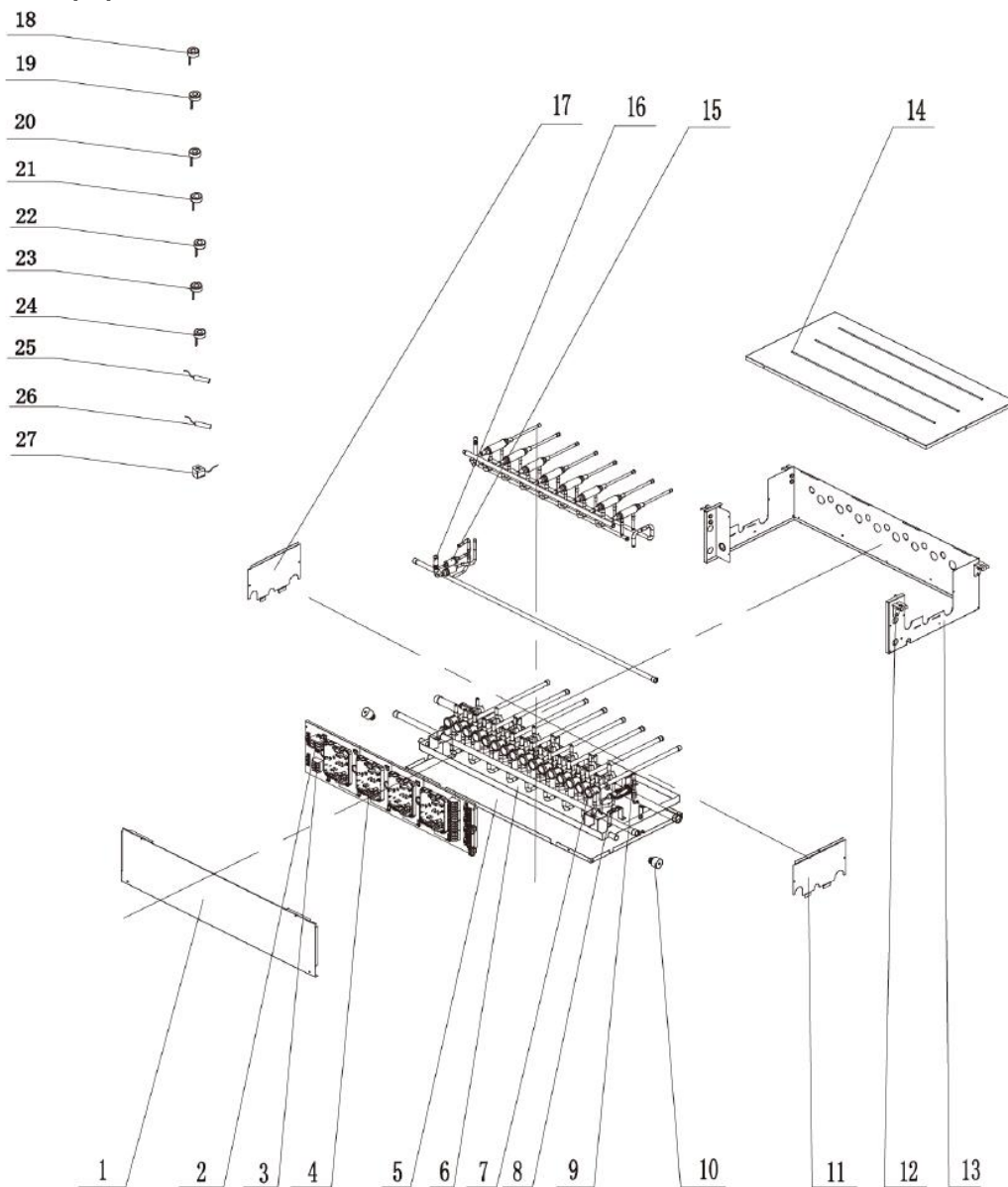

No.	Name of part	NCHS8B(U)	
		Product Code	EN04001140
		Part code	Quantity
1	Coping	'012020060142P	1
2	Terminal Board	'422000000014	1
3	Terminal Board	'42018000026	5
4	Pinboard	'300023000009	4
5	Chassis	'01284100142P	1
6	Water Tray Sub_Assy	'01284100153P	1
7	Electromagnetic Valve	'43000073	2
8	Strainer	'07415200002	1
9	Electromagnetic Valve	'43000054	2
10	Choke plug of Drain Pipe	'76712455	2
11	Seal plate	'01494100018P	1
12	Hook	'02112446	4
13	Side Plate	'01314100102P	1
14	Top Cover	'012035000094	1
15	Strainer	'0741410000601	2
16	Electronic Expansion Valve	'07334463	1
17	Seal Plate	'01494100017P	1
18	Magnet Coil	'4304000428	1
19	Magnet Coil	'4304000448	4
20	Magnet Coil	'4304000447	4
21	Magnet Coil	'4304000449	4
22	Magnet Coil	'4304000446	4
23	Magnet Coil	'4304000450	4
24	Magnet Coil	'4304000451	4
25	Temperature Sensor	'3900012139G	1
26	Temperature Sensor	'3900012121G	1
27	Electric Expand Valve Fitting	'4304413205	1
Note: Above data is subject to change without notice, please refer the SP in global service website.			



Jf00303410



GREE ELECTRIC APPLIANCES, INC. OF ZHUHAI 519070

Add: West Jinji Rd, Qianshan Zhuhai, Guangdong, China

Tel: (+86-756)8522218

Fax: (+86-756)8669426

E-mail: gree@gree.com.cn www.gree.com