

Installation, Operation & Maintenance Manual

CI-2™



NOTICE: This product is to be used only as directed. Read entire manual before use. Do not use unless properly installed.



Thank you for purchasing a CI-2™ air ionization system from GPS Air.

What's Included

Before you start, confirm the contents of your shipment. Each CI-2™ will consist of the following:

1. CI-2 Air Ionization System
2. CI-2 Mounting Bracket
3. Installation Fasteners (2)



(1)



(1)



(2)

Not Included

1. Electrical wiring, junction box, or receptacle to provide power to the CI-2

As part of the installation process, a Startup Document should be completed. For the latest version of the document, visit our website or utilize the QR code.

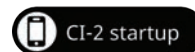

Location



WARNING: Make sure power is disconnected to the HVAC equipment before installation.

NOTE: Use temperature - Maximum ambient temperature in which unit shall be used: 140°F/60°C.

AVERTISSEMENT: Assurez-vous que l'alimentation de l'équipement HVAC est débranchée avant l'installation.

REMARQUE: Température d'utilisation - Température ambiante maximale à laquelle l'unité doit être utilisée: 140°F/60°C.

The CI-2 is capable of being installed in a wide range of applications. Actual location and suitability will vary based on equipment manufacturer. Some recommended installations are below.

NOTE: Device should be installed after any filtration in system.



Installation

1. Review the installation video at our website or scan the QR code opposite.
2. The integral magnet (see Figure 1) can be used in low vibration locations on ferrous surfaces.
3. The mounting bracket should be used with appropriate fasteners in high vibration and on non-ferrous surfaces. (See Figure 2)
4. Airflow should be aligned with the indicator on the CI-2. (See Figure 3)



Figure 1

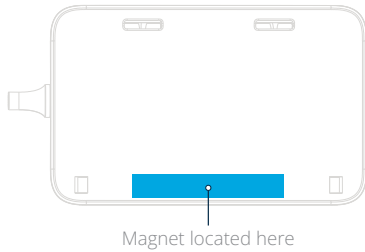

Figure 2

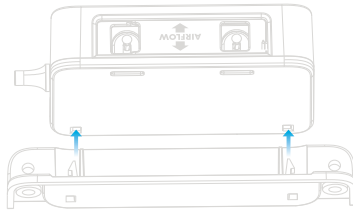
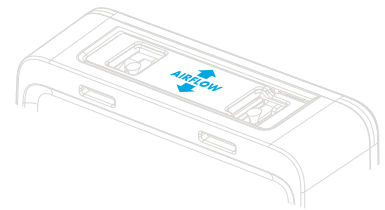
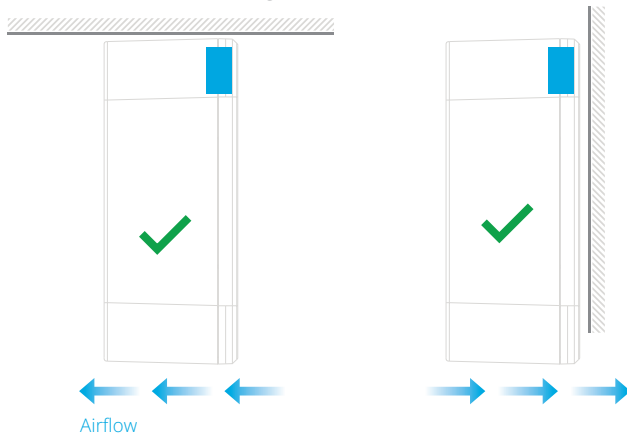

Figure 3



Installation Methods

Magnet Installation



Bracket Installation

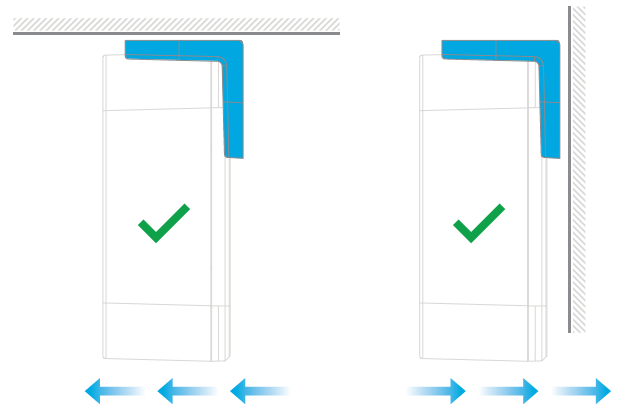

Improper Installation Methods

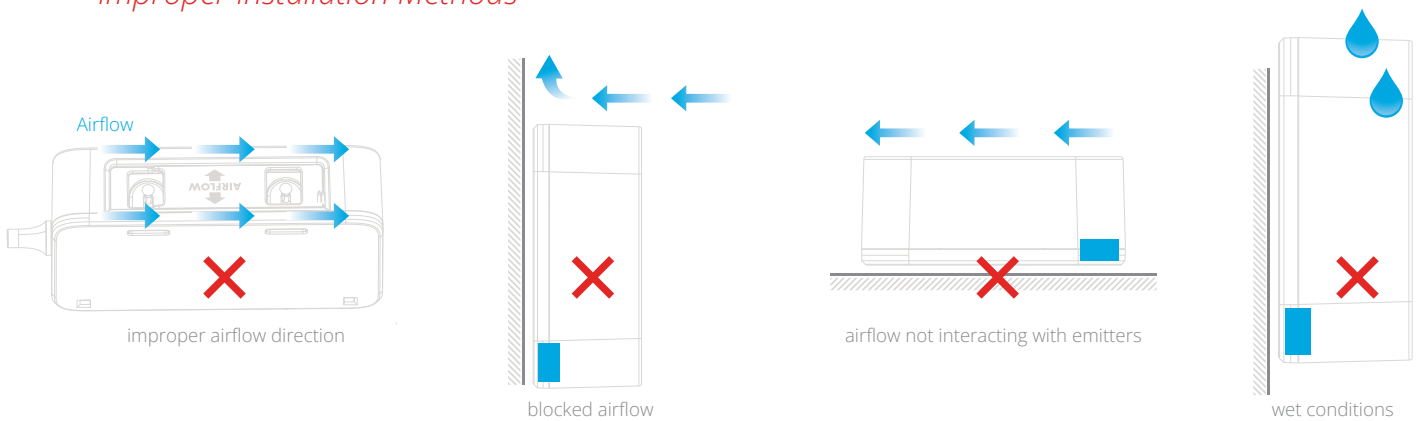

Ceiling Cassette

1. Optimum installation location is on the fan inlet shroud.
2. Ensure installation of device does not hinder or interfere with any covers on ceiling cassette.

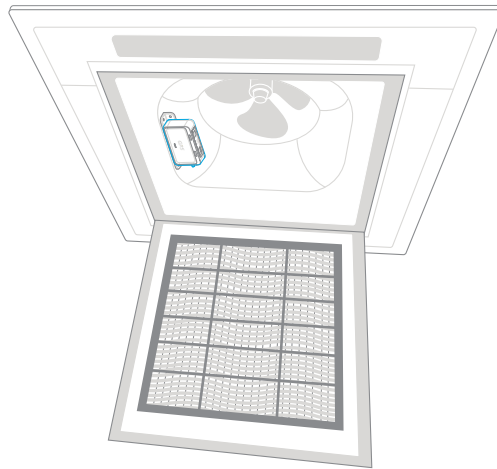

Air Handler

1. Optimum installation location is on the fan inlet.

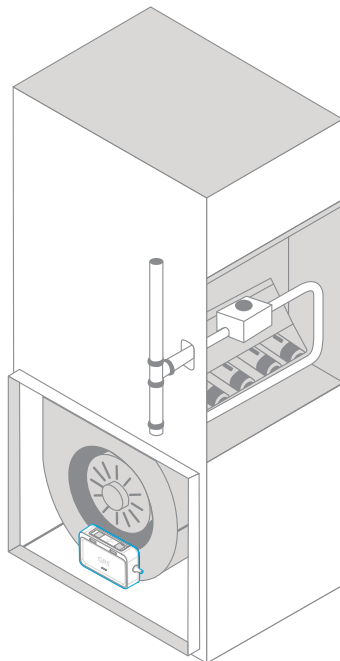

Mini Split

1. Mini splits are compact by design and configurations will vary greatly between manufacturers.
2. The blower outlet and coils are the most likely installation locations.
3. Ensure installation of the CI-2 does not hinder covers and guards.

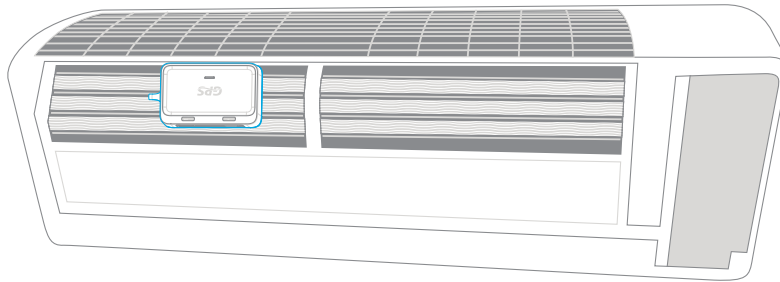

PTAC

1. PTAC units are compact by design and configurations will vary greatly between manufacturers.
2. The blower outlet and coils are the most likely locations.
3. Ensure installation of the CI-2 does not hinder covers and guards.

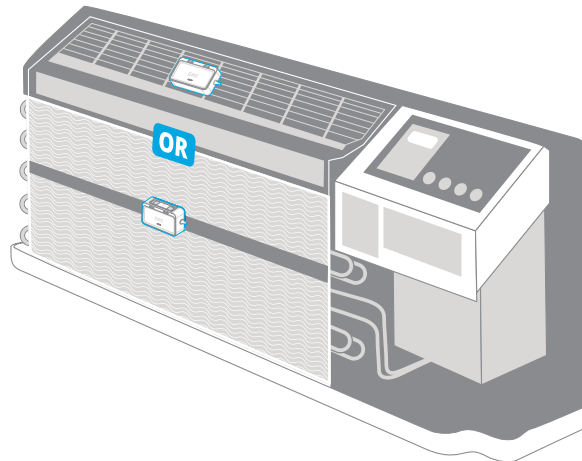

Wiring

1. GPS recommends the CI-2 be powered constantly and NOT switched with the system or blower.
2. The CI-2 requires a 24VAC or 12-36VDC source. Connect the power wires as follows:

Black = Neutral

Red = Line

Green = Dry Contacts / BAS Alarm

White = Dry Contacts / BAS Alarm

3. Wire in BAS terminals (optional). The CI-2 is equipped with a set of dry contacts that are normally open and close when the CI-2 is on and has no faults. The contacts are rated up to 125VAC and 300mA.
4. GPS PS-2 (optional). For incoming voltages from 110-277VAC.

Operation



CAUTION! Never touch brushes while operating, shock may occur.

ATTENTION: Ne touchez jamais les brosses pendant le fonctionnement, un choc peut se produire.

Once powered, the unit initiates an internal check of all systems. If the auto cleaning wiper blade is not in the "home" position, it will move to the home position in series with the airflow.

Cleaning Cycle

The CI-2 comes with a preset cleaning cycle designed to clean the brushes once every day.

Troubleshooting

1. Unit will not power up, LED not illuminated:
 - a. Confirm proper voltage is applied to the correct terminal(s).
 - b. Try disconnecting and re-applying the power source.
2. If the unit does not operate properly after verifying the above instructions please contact GPS for additional assistance.

Product Registration

By registering your order, the standard limited warranty on eligible products from your purchase is automatically extended to 3 years, at no additional cost.

Register your products at www.gpsair.com/product-registration or scan the QR code.



The information provided in this manual is up to date at the time of printing. Any revisions to this document will supersede the content included. For the latest applicable version of this manual, visit our website or utilize the QR code.

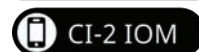

3101 Yorkmont Road • Suite 400
Charlotte, NC 28208
980-279-5622



To access a list of applicable patents, please visit www.gpspatents.com

